

TM 10-8470-210-10

TECHNICAL MANUAL
OPERATOR'S MANUAL
FOR
**IMPROVED OUTER TACTICAL VEST
GEN III (IOTV GEN III)**

PART OF THE
INTERCEPTOR BODY ARMOR SYSTEM



DISTRIBUTION STATEMENT A – Approved for public release; distribution is unlimited.

**HEADQUARTERS, DEPARTMENT OF THE ARMY
1 DECEMBER 2012**

WARNING SUMMARY

This warning summary contains general safety warnings and hazardous materials warnings that must be understood and applied during operation and maintenance of this equipment. Failure to observe these precautions could result in serious injury or death to personnel. Also included are explanations of safety and hazardous material icons used within the technical manual.

FIRST AID DATA

For first aid information, refer to FM 4-25.11.

WARNING DESCRIPTIONS

WARNING

Ensure the sizes of the front and back carrier match by comparing information on the data label. Ensure the sizes of the attachable items match the sizes of the front and back carriers by comparing data plate information. Failure to do so could affect performance, causing injury or death.

WARNING

Ensure there are no kinks in the emergency release assembly. Failure to do so could adversely affect the function of the emergency release, causing injury or death.

WARNING

When the IOTV Gen III is assembled with additional equipment that attaches to both the front and back carriers, such as a rucksack or the Tactical Assault Panel (TAP), one side of the equipment must be detached for the emergency release function to work properly. Failure to do so could affect performance, causing injury or death.

WARNING

Ensure front and back carrier soft ballistic protection overlaps under the arm when donning the vest.

WARNING

The emergency release system should be used during emergencies or for instructional purposes only. Using the emergency release method to routinely doff the vest could result in damage to the hard armor plates. Damage to the hard armor plates could result in injury or death to the wearer.

WARNING DESCRIPTIONS – CONTINUED

WARNING

Do not machine wash or dry. Failure to follow these instructions may render your IBA unserviceable.

WARNING

Do not machine wash or dry the SAPI/SBI inserts. Failure to follow these instructions may degrade the SAPI/SBI ballistic protection.

WARNING

Soldiers must ensure they have the correct protective inserts. The ESAPI and ESBI have green covers and the XSAPI and XSBI have tan covers. All of these inserts provide a higher level of protection than the Small Arms Protective Insert (SAPI) and the Side Ballistic Inserts (SBI) which have black covers.

ESAPI should be worn by all personnel in-theater. If a service member has the older black SAPI plates, they should be turned in and replaced with green ESAPI plates. Failure to ensure the correct plate while conducting combat operations may result in injury or death.

WARNING

Fabric repair in this work package does not apply to the fabric on the soft ballistic inserts. Any damage to the soft ballistic inserts is cause for turn in. Failure to follow these instructions could result in degraded ballistic protection.

WARNING

Pressing, starching, dry cleaning, or the use of fabric softener will degrade the IBA. Failure to following these instructions could result in harm to the Soldier.

LIST OF EFFECTIVE PAGES/WORK PACKAGES

NOTE: Zero in the "Change No." column indicates an original page or work package.

Original: 1 December 2012

TOTAL NUMBER OF PAGES FOR FRONT AND REAR MATTER IS 26 AND TOTAL NUMBER OF WORK PACKAGES IS 20, CONSISTING OF THE FOLLOWING:

| Page / WP No. | Change No. |
|-------------------------|-------------------|
| Front Cover | 0 |
| Warning (2 pgs) | 0 |
| i-viii (8 pgs) | 0 |
| Ch 1 title page (2 pgs) | 0 |
| WP 0001 (4 pgs) | 0 |
| WP 0002 (16 pgs) | 0 |
| WP 0003 (2 pgs) | 0 |
| Ch 2 title page (2 pgs) | 0 |
| WP 0004 (2 pgs) | 0 |
| WP 0005 (32 pgs) | 0 |
| WP 0006 (4 pgs) | 0 |
| WP 0007 (4 pgs) | 0 |
| WP 0008 (2 pgs) | 0 |
| Ch 3 title page (2 pgs) | 0 |
| WP 0009 (2 pgs) | 0 |
| WP 0010 (18 pgs) | 0 |
| Ch 4 title page (2 pgs) | 0 |
| WP 0011 (2 pgs) | 0 |
| WP 0012 (4 pgs) | 0 |
| WP 0013 (2 pgs) | 0 |
| WP 0014 (2 pgs) | 0 |
| WP 0015 (8 pgs) | 0 |
| Ch 5 title page (2 pgs) | 0 |
| WP 0016 (2 pgs) | 0 |
| WP 0017 (8 pgs) | 0 |
| WP 0018 (2 pgs) | 0 |
| WP 0019 (2 pgs) | 0 |
| WP 0020 (2 pgs) | 0 |
| Back cover | 0 |

HEADQUARTERS
DEPARTMENT OF THE ARMY
WASHINGTON, D.C., 1 DECEMBER 2012

TECHNICAL MANUAL
OPERATOR'S MANUAL
FOR
IMPROVED OUTER TACTICAL VEST GEN III
(IOTV GEN III)
PART OF THE
INTERCEPTOR BODY ARMOR SYSTEM

REPORTING ERRORS AND RECOMMENDING IMPROVEMENTS

You can help improve this publication. If you find any errors, or if you would like to recommend any improvements to the procedures in this publication, please let us know.

The preferred method is to submit your DA Form 2028 (Recommended Changes to Publications and Blank Forms) through the Internet on the TACOM Unique Logistics Support Applications (TULSA) Web site. The Internet address is <https://tulsa.tacom.army.mil>. Access to all applications requires CAC authentication, and you must complete the Access Request form the first time you use it. The DA Form 2028 is located under the TULSA Applications on the left-hand navigation bar. Fill out the form and click on SUBMIT. Using this form on the TULSA Web site will enable us to respond more quickly to your comments and to better manage the DA Form 2028 program. You may also mail, e-mail, or fax your comments or DA Form 2028 directly to the U.S. Army TACOM Life Cycle Management Command. The postal mail address is U.S. Army TACOM Life Cycle Management Command, ATTN: AMSTA-LCL-MPP/ TECH PUBS, MS-727, 6501 E. 11 Mile Road, Warren, MI 48397-5000. The e-mail address is tacomlcmc.daform2028@us.army.mil. The fax number is DSN 786-1856 or Commercial (586) 282-1856. A reply will be furnished to you.

DISTRIBUTION STATEMENT A: Approved for public release; distribution is unlimited.

TABLE OF CONTENTS

Page No.
WP Sequence No.

How to Use This Manual.....vii

**Chapter 1 – General Information, Equipment Description,
and Theory of Operation**

| | |
|---|-------------|
| General Information | WP 0001 |
| Table 1. Nomenclature Cross Reference List | WP 0001 -2 |
| Table 2. List of Abbreviations/Acronyms..... | WP 0001 -3 |
| Equipment Description and Data | WP 0002 |
| Figure 1. Front Carrier..... | WP 0002 -2 |
| Figure 2. Front Ballistic Insert | WP 0002 -3 |
| Figure 3. Back Carrier..... | WP 0002 -4 |
| Figure 4. Back Ballistic Insert..... | WP 0002 -5 |
| Figure 5. Side Plate Carrier (Exterior)..... | WP 0002 -5 |
| Figure 6. Side Plate Carrier (Interior) with Pocket | WP 0002 -5 |
| Figure 7. Yoke/Collar Assembly (Exterior)..... | WP 0002 -6 |
| Figure 8. Yoke/Collar Assembly (Interior) | WP 0002 -6 |
| Figure 9. Emergency Release Assembly | WP 0002 -7 |
| Figure 10. Emergency Release Strap | WP 0002 -8 |
| Figure 11. Emergency Release Cable Connections | WP 0002 -8 |
| Figure 12. Lower Back Protector (Exterior)..... | WP 0002 -9 |
| Figure 13. Lower Back Protector (Interior)..... | WP 0002 -9 |
| Figure 14. Deltoid Protectors (Exterior) | WP 0002 -10 |
| Figure 15. Deltoid Protectors (Interior)..... | WP 0002 -10 |
| Figure 16. Groin Protector (Interior)..... | WP 0002 -11 |
| Figure 17. Groin Protector (Exterior)..... | WP 0002 -11 |
| Figure 18. Interior and Exterior Faces of ESAPI..... | WP 0002 -12 |
| Figure 19. IOTV Gen III Assembly (Front View) | WP 0002 -13 |
| Figure 20. IOTV Gen III Assembly (Back View)..... | WP 0002 -14 |

| | |
|--|------------|
| Table 1. IOTV Gen III System Weight Chart (in pounds)..... | WP 0002-16 |
| Table 2. Hard Armor Ballistic Inserts Weight Chart (in pounds) | WP 0002-16 |
| Theory of Operation..... | WP 0003 |

Chapter 2 – Operator Instructions

| | |
|--|------------|
| Description and Use of Operator Controls and Indicators..... | WP 0004 |
| Operation Under Usual Conditions – Assembly and Preparation for Use | |
| Table 1. IOTV Gen III Inventory | WP 0005-2 |
| Table 2. IOTV Gen III Component Sizing Chart..... | WP 0005-5 |
| Figure 1. Front Vest Carrier with Exterior Facing Down | WP 0005-6 |
| Figure 2. Soft Ballistic Insert Folded. | WP 0005-7 |
| Figure 3. Flatten Soft Ballistics..... | WP 0005-7 |
| Figure 4. Lower Back Protector Carrier with Ballistic Insert..... | WP 0005-8 |
| Figure 5. Deltoid Protector Carrier with Ballistic Insert | WP 0005-9 |
| Figure 6. Groin Protector Carrier..... | WP 0005-9 |
| Figure 7. Plastic and Soft Ballistic Inserts in Groin Protector Carrier | WP 0005-10 |
| Figure 8. Hard Armor Pocket in Front Vest Carrier..... | WP 0005-11 |
| Figure 9. Hard Armor in Front Vest Carrier..... | WP 0005-11 |
| Figure 10. Hard Armor Pocket Closed | WP 0005-12 |
| Figure 11. Top Access Panel Open | WP 0005-13 |
| Figure 12. Additional Pockets for Hard Armor | WP 0005-14 |
| Figure 13. Webbing Straps on Yoke/Collar Assembly | WP 0005-15 |
| Figure 14. Lower Straps Threaded. | WP 0005-15 |
| Figure 15. Front Yoke/Collar Aligned..... | WP 0005-16 |
| Figure 16. Hook and Loop Aligned. | WP 0005-16 |
| Figure 17. Straps on Back of Yoke/Collar..... | WP 0005-17 |
| Figure 18. Back Yoke/Collar Aligned | WP 0005-17 |
| Figure 19. Side Plate Carriers..... | WP 0005-18 |
| Figure 20. Right Side Plate Carrier with Side Plate Pocket..... | WP 0005-18 |
| Figure 21. PALS on Side Plate Pocket and Carrier | WP 0005-19 |

| | |
|--|-------------|
| Figure 22. Pocket Flap Over SAPI | WP 0005 -20 |
| Figure 23. Webbing Hanger Snap Open..... | WP 0005 -21 |
| Figure 24. Webbing Hanger on Side Plate Carrier | WP 0005 -22 |
| Figure 25. Front and Back Vest Carriers | WP 0005 -23 |
| Figure 26. Shoulder Overlays Open | WP 0005 -24 |
| Figure 27. Buckle at Shoulder..... | WP 0005 -24 |
| Figure 28. Fasten Hook and Loop at Shoulder | WP 0005 -25 |
| Figure 29. Lower Back Protector Attached to Back Carrier | WP 0005 -26 |
| Figure 30. Attach Deltoid Protector to Vest Assembly..... | WP 0005 -27 |
| Figure 31. Strap Fastened to Deltoid Protector | WP 0005 -28 |
| Figure 32. Groin Protector Attached Properly..... | WP 0005 -29 |
| Figure 33. Groin Protector Clipped to Trousers | WP 0005 -30 |
| Figure 34. Groin Protector Attached to Belt Loops | WP 0005 -30 |
| Figure 35. Attach Groin Protector to Front Vest Carrier | WP 0005 -31 |
| Figure 36. Buttonhole on Groin Protector | WP 0005 -31 |
| Operation Under Usual Conditions – Don, Doff | WP 0006 |
| Figure 1. Secure Side Plate Carrier | WP 0006 -2 |
| Figure 2. Attach Side Plate Carrier | WP 0006 -2 |
| Figure 3. Emergency Release Strap..... | WP 0006 -4 |
| Operation Under Usual Conditions – Evaluate and Adjust Fit | WP 0007 |
| Figure 1. Webbing Hanger Lock Released | WP 0007 -2 |
| Operation Under Unusual Conditions..... | WP 0008 |

Chapter 3 – Preventive Maintenance Checks and Services

| | |
|---|------------|
| Preventive Maintenance Checks and Services (PMCS) – Introduction .. | WP 0009 |
| Preventive Maintenance Checks and Services (PMCS) | WP 0010 |
| Table 1. Preventive Maintenance Checks and Services | WP 0010-2 |
| Figure 1. Smoothing Out IOTV | WP 0010-3 |
| Figure 2. Inspect Plates | WP 0010-4 |
| Figure 3. Emergency Release Assembly..... | WP 0010-7 |
| Figure 4. Removing Hard Armor Plates from Front Carrier | WP 0010-10 |

| | |
|---|------------|
| Figure 5. Removing Soft Ballistic Inserts | WP 0010-10 |
| Figure 6. Removing Yoke/Collar Assembly | WP 0010-11 |
| Figure 7. Cleaning Restrictions | WP 0010-13 |
| Figure 8. Installing Soft Ballistic Inserts | WP 0010-15 |

Chapter 4 – Maintenance Instructions

| | |
|--|-----------|
| Preparation for Shipment and Storage | WP 0011 |
| Service – Cleaning and Drying | WP 0012 |
| IOTV Gen III – Fabric Repair | WP 0013 |
| Figure 1. Straight Stitch..... | WP 0013-1 |
| Figure 2. Edge Sew..... | WP 0013-1 |
| Figure 3. Turn Edge Under and Sew | WP 0013-2 |
| Hard Armor – Inspect, Repair | WP 0014 |
| Hardware and Emergency Release Assembly – Inspect, Repair | WP 0015 |
| Figure 1. Catch Lever on Buckle..... | WP 0015-1 |
| Figure 2. Cable in Buckle | WP 0015-2 |
| Figure 3. Correct and Secure Placement of the Cable | WP 0015-3 |
| Figure 4. Incorrect Placement of the Cable | WP 0015-3 |
| Figure 5. Adjustable Buckle on Side Plate Carrier..... | WP 0015-4 |
| Figure 6. Catch Lever on Buckle..... | WP 0015-5 |
| Figure 7. Emergency Release Assembly..... | WP 0015-5 |
| Figure 8. Cable Connection Points | WP 0015-6 |
| Figure 9. Emergency Release Assembly Strap and Buckle Reinforcement | WP 0015-7 |

Chapter 5 – Supporting Information

| | |
|---|-----------|
| References | WP 0016 |
| Components of End Item (COEI) and Basic Issue Items (BII) Lists | WP 0017 |
| Table 1. Components of End Item (COEI) List | WP 0017-2 |
| Table 2. Basic Issue Items (BII) List | WP 0017-7 |

Additional Authorization List (AAL)..... WP 0018
 Table 1. Additional Authorization List..... WP 0018-2
Expendable and Durable Items List..... WP 0019
 Table 1. Expendable and Durable Items List 0019-1
Support Items WP 0020
 Table 1. Additional Items List..... WP 0020-1

HOW TO USE THIS MANUAL

HOW TO OBTAIN TECHNICAL MANUALS

When a new system is introduced to the Army inventory, it is the responsibility of the receiving units to notify and inform the Unit Publications Clerk that a Technical Manual is available for the new system. Throughout the life cycle of the new system, the Publications Proponent will also provide updates and changes to the Technical Manual.

To receive new Technical Manuals or change packages to fielded Technical Manuals, provide the Unit Publications Clerk the full Technical Manual number, title, date of publication, and number of copies required. The Unit Publications Clerk will then justify the request through the Unit Publications Officer. When the request is approved, DA Form 12-R is used to order the Technical Manual from the Army Publishing Directorate (APD). Obtain the form and request a publications account from the APD Web site at <http://www.apd.army.mil>. Once on the Website click on the Orders/Subscriptions/Reports” tab. From the dropdown menu, select “Establish an Account,” then select “Tutorial” and follow the instructions in the tutorial presentation.

Complete information for obtaining Army publications can be found in DA PAM 25-33.

Organization of This Manual

In this manual, primary chapters appear in upper case/capital letters; work packages are presented in numeric sequence, e.g., 0001, 0002; paragraphs within a work package are not numbered and are presented in a titled format. For a first level paragraph, titles are in all bold, uppercase, capital letters, e.g., **FRONT MATTER**. Subordinate paragraph titles are uppercase for the first letter of the first word of each principle word, all bold, e.g., **Manual Organization and Page Numbering System**. The location of additional material that must be referenced is clearly marked. Illustrations supporting maintenance procedures/text are located underneath, or as close as possible to, their referenced paragraph. Notes, Cautions, and Warnings are located directly above the procedure to which they apply.

FRONT MATTER. Front matter consists of front cover, warning summary, title block, table of contents, and how to use this manual page.

CHAPTER 1 - GENERAL INFORMATION, EQUIPMENT DESCRIPTION, AND THEORY OF OPERATION. Chapter 1 contains introductory information on the Interceptor Body Armor (IBA) as well as theory of operation.

HOW TO USE THIS MANUAL – CONTINUED

CHAPTER 2 - OPERATOR INSTRUCTIONS. Chapter 2 contains information on assembling, donning, doffing and operating the IBA system.

CHAPTER 3 – PREVENTIVE MAINTENANCE CHECKS AND SERVICES. Chapter 3 identified preventive maintenance checks and services information.

CHAPTER 4 – MAINTENANCE INSTRUCTIONS. Chapter 4 provides maintenance procedures, preparations for storage and shipment authorized at the service level.

CHAPTER 5 - SUPPORTING INFORMATION. Chapter 5 contains references, Components of End Items List (COEI), Basic Issue Items List (BIIL), and expendable and durable items list.

REAR MATTER. Rear matter consists of alphabetical index, DA Form 2028, authentication page, and back cover.

Manual Organization and Page Numbering System. The manual is divided into eight major chapters that detail the topics mentioned above. Within each chapter are work packages covering a wide range of topics. Each work package is numbered sequentially starting at page 1. The work package has its own page numbering scheme and is independent of the page numbering used by other work packages. Each page of a work package has a page number of the form XXXX-YY where XXXX is the work package number (e.g. 0010 is work package 10) and YY represents the number of the page within that work package. A page number such as 0010-1/2 blank means that page 1 contains information but page 2 of that work package has been intentionally left blank.

Finding Information. The table of contents permits the reader to find information in the manual quickly. The reader should start here first when looking for a specific topic. The table of contents lists the topics, figures, and tables contained within each chapter and the work package sequence number where it can be found.

WARNINGS, CAUTIONS, AND NOTES

A warning identifies a clear danger to the person doing that procedure.

A caution identifies risk of damage to the equipment.

A note is used to highlight essential procedures, conditions, or statements or convey important instructional data to the user.

CHAPTER 1

**GENERAL INFORMATION, EQUIPMENT DESCRIPTION,
AND THEORY OF OPERATION**

FOR

**IMPROVED OUTER TACTICAL VEST GEN III
(IOTV GEN III)**

**OPERATOR MAINTENANCE
IMPROVED OUTER TACTICAL VEST GEN III
GENERAL INFORMATION**

SCOPE

This technical manual provides operator instructions for the Improved Outer Tactical Vest (IOTV) Gen III, Small Arms Protective Insert, Side Ballistic Inserts, and ancillary equipment of the Interceptor Body Armor (IBA) system.

MAINTENANCE FORMS, RECORDS, AND REPORTS

Department of the Army forms and procedures used for equipment maintenance will be those prescribed by (as applicable) DA PAM 750-8, The Army Maintenance Management System (TAMMS) Users Manual; DA PAM 738-751, Functional Users Manual for the Army Maintenance Management Systems - Aviation (TAMMS-A); or AR 700-138, Army Logistics Readiness and Sustainability.

REPORTING EQUIPMENT IMPROVEMENT RECOMMENDATIONS (EIR)

If your IOTV Gen III needs improvement, let us know. Send us an EIR. You, the user, are the only one who can tell us what you do not like about your equipment. Let us know why you do not like the design or performance. If you have Internet access, the easiest and fastest way to report problems or suggestions is to follow the instructions and links below:

For ALL non-Aviation/Missile Warranty, EIR and PQDRs, submit through the Web Product Quality Deficiency Reporting (PQDR) site. The Web PQDR Web site is: <http://www.nslcptsmh.csd.disa.mil/webpqdr/webpqdr.htm>.

New accounts can be established at the following address:
<http://www.nslcptsmh.csd.disa.mil/accessforms/uarform.htm>.

You may also submit your information using an SF 368 (Product Quality Deficiency Report). You can send your SF 368 using e-mail, regular mail, or fax using the addresses/fax numbers specified in (DA PAM 750-8, The Army Maintenance Management System (TAMMS) Users Manual OR DA PAM 738-751. We will send you a reply.

CORROSION PREVENTION AND CONTROL (CPC)

Corrosion Prevention and Control (CPC) of Army materiel is a continuing concern. It is important that any corrosion problems with any items be reported so that the problem can be corrected and improvements can be made to prevent the problem in future items.

Plastics, composites, and rubbers can also degrade. Degradation is caused by thermal (heat), oxidation (oxygen), solvation (solvents), or photolytic (light, typically UV) processes. The most common exposures are excessive heat or light. Damage from these processes will appear as cracking, softening, swelling, and/or breaking.

SF Form 368, Product Quality Deficiency Report should be submitted to the address specified in DA PAM 750-8, The Army Maintenance Management System (TAMMS) Users Manual.

DESTRUCTION OF ARMY MATERIEL TO PREVENT ENEMY USE

Destruction of Army materiel to prevent enemy use shall be in accordance with TM 750-244-1-2.

PREPARATION FOR STORAGE OR SHIPMENT

Refer to WP 0011 for storage and shipping procedures.

NOMENCLATURE CROSS REFERENCE LIST

Table 1. Nomenclature Cross-Reference List.

| COMMON NAME | OFFICIAL NOMENCLATURE |
|-------------------------------|--|
| 100 mile-per-hour Tape | Pressure Sensitive Adhesive Tape |
| Ballistic Collar | Yoke/Collar Assembly |
| Emergency Release Assembly | Improved Outer Tactical Vest Cord Cable Assembly |
| Duct Tape | Pressure Sensitive Adhesive Tape |
| Hard Armor Protective Inserts | Small Arms Protective Inserts |
| Hard Armor Protective Inserts | Enhanced Small Arms Protective Inserts |
| Hard Armor Protective Inserts | X-Small Arms Protective Insert |
| Hard Armor Protective Inserts | Enhanced Side Ballistic Inserts |
| Lower Back Protector | Kidney Protector Body Armor |
| Rigger's Tape | Pressure Sensitive Adhesive Tape |
| Webbing | Pouch Attachment Ladder System |

LIST OF ABBREVIATIONS AND ACRONYMS

Table 2. List of Abbreviations/Acronyms.

| ABBREVIATION / ACRONYM | DEFINITION |
|------------------------|---|
| ACU | Army Combat Uniform |
| BII | Basic Issue Item |
| CIF | Central Issue Facility |
| COEI | Component of End Item |
| ea | Each |
| EIR | Equipment Improvement Recommendation |
| ESAPI | Enhanced Small Arms Protective Inserts |
| ESBI | Enhanced Side Ballistic Inserts |
| FM | Field Manual |
| ft | Foot |
| IBA | Interceptor Body Armor |
| IOTV | Improved Outer Tactical Vest |
| lb | Pound(s) |
| MOLLE | Modular Lightweight Load-Carrying Equipment |
| NIIN | National Item Identification Number |
| NSN | National Stock Number |
| P/N | Part Number |
| PALS | Pouch Attachment Ladder System |
| PMCS | Preventive Maintenance Checks and Services |
| SAPI | Small Arms Protective Inserts |
| SBI | Side Ballistic Inserts |
| SF | Standard Form |
| TAP | Tactical Assault Panel |
| TM | Technical Manual |
| U | Universal |
| WP | Work Package |
| XSAPI | X Small Arms Protective Inserts |
| XSBI | X Side Ballistic Inserts |
| XS | Extra-Small |
| S | Small |
| M | Medium |
| ML | Medium-Long |
| L | Large |

LIST OF ABBREVIATIONS AND ACRONYMS - CONTINUED**Table 2. List of Abbreviations/Acronyms - Continued.**

| ABBREVIATION / ACRONYM | DEFINITION |
|-------------------------------|-------------------------------|
| LL | Large-Long |
| XL | Extra-Large |
| XLL | Extra Large-Long |
| 2XL | Extra Extra Large |
| 3XL | Extra Extra Extra Large |
| 4XL | Extra Extra Extra Extra Large |

END OF WORK PACKAGE

OPERATOR MAINTENANCE
IMPROVED OUTER TACTICAL VEST GEN III
EQUIPMENT DESCRIPTION AND DATA

EQUIPMENT CHARACTERISTICS, CAPABILITIES, AND FEATURES

The Interceptor Body Armor (IBA) system is a modular system that consists of a vest assembly, hard armor, and ancillary equipment (attachments) that increase the area of coverage and level of protection.

The IBA system is issued to Soldiers in a variety of configurations contingent upon operations. Some vest assemblies are issued with ancillary equipment while with other vest assemblies ancillary equipment is issued separately.

Therefore, the term ancillary equipment, as used in this manual, is used to describe the attachments to the base vest configuration. Refer to the Components of End Item (COEI) and Basic Issue Items (BII) lists to determine how ancillary equipment is issued.

Vest Assembly

The IBA vest assembly (IOTV Gen III) consists of a front carrier, a back carrier, an emergency release assembly, a yoke and collar assembly, and a side plate carrier.

Ancillary Equipment

Ancillary equipment includes the deltoid protectors, lower back protector, and groin protector. The deltoid and lower back protectors are designed to be worn attached to the vest assembly. The groin protector is designed to be worn attached to the ACU trousers. These items increase the area of ballistic protection when worn correctly. Some ancillary equipment may be issued as a part of the base vest assembly contingent upon operations.

Hard Armor

There are two types of hard armor, Small Arms Protective Inserts (SAPI) and Side Ballistic Inserts (SBI). SAPI hard armor includes Enhanced Small Arms Protective Inserts (ESAPI) and the X Small Arms Protective Inserts (XSAPI). SBI hard armor includes Enhanced Side Ballistic Inserts (ESBI) and X Side Ballistic Inserts (XSBI). The hard armor plates provide additional levels of protection to the front, back, and sides of the Soldier.

Interoperability

The IOTV Gen III is compatible with Modular Lightweight Load-carrying Equipment (MOLLE) components and with the Nett Warrior System.

LOCATION AND DESCRIPTION OF MAJOR COMPONENTS

Vest Assembly

Front Carrier. The front carrier (Figure 1) attaches to the back carrier and side plate carrier with buckles.

In the center of the neckline is the location for rank placement. Behind the rank placement is a pocket for storage of the quick release handle of the emergency release assembly. There is also a location for the name tape placement on the right side of the chest area.

Pouch Attachment Ladder System (PALS) (webbing) is sewn on the front panel of the vest for attaching items.

The buckle ends used to attach the side plate carriers are underneath the front panel of the vest. The pull strap attached to the front panel is used to lift up the panel. The data label for the vest with essential information is located on the inside of the front carrier.



Figure 1. Front Carrier.

LOCATION AND DESCRIPTION OF MAJOR COMPONENTS – CONTINUED**Vest Assembly – Continued**

Front Ballistic Insert. The soft front ballistic insert is located inside the front carrier and provides ballistic protection. The front ballistic insert has loop fastener tape and a data label (Figure 2).



Figure 2. Front Ballistic Insert.

Back Carrier. The back carrier (Figure 3) has two shoulder straps with attached buckles to which the front carrier attaches. On the upper portion of the back carrier there is a drag strap located on the upper center portion of the carrier.

There are two panels, both of which seal with hook and loop tape. The smaller, upper access panel just below the drag strap provides access to the pockets for the hard armor. The larger, lower panel provides access to the adjustment points for the side plate carrier.

Under the lower panel there are two rows of webbing to which the side plate carrier attaches with a webbing hanger. The webbing loops on the end of the plate carriers attach to the webbing loops on the back carrier with the webbing hanger. The webbing hanger runs through the webbing loops on the side plate carrier and the back carrier, and secures the two together.

LOCATION AND DESCRIPTION OF MAJOR COMPONENTS – CONTINUED

Vest Assembly – Continued

Back Carrier – Continued.

All sizes of the back carrier (except the extra large) are designed with two outside pockets for SAPI plates—the innermost pocket (closest to the body) is for a SAPI that is the same size as the IOTV Gen III. The second, larger pocket closest to the vest exterior is designed for a SAPI that is the next size larger than the IOTV Gen III. Both pockets are accessed by lifting the upper access panel.



Figure 3. Back Carrier.

LOCATION AND DESCRIPTION OF MAJOR COMPONENTS – CONTINUED

Vest Assembly – Continued

Back Ballistic Insert. The soft back ballistic insert is located inside the back carrier and provides ballistic protection. The back ballistic insert has loop fastener tape and a data label (Figure 4).



Figure 4. Back Ballistic Insert.

Side Plate Carriers. The side plate carriers are universal and either can be used on the left or right side. The side plate pockets that attach to the inside of the side plate carriers are also universal and hold the SBI plates (Figures 5 and 6).

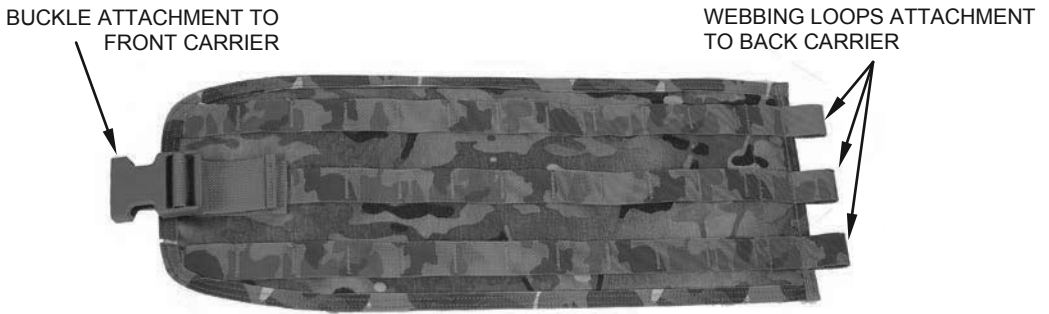

Figure 5. Side Plate Carrier (Exterior).

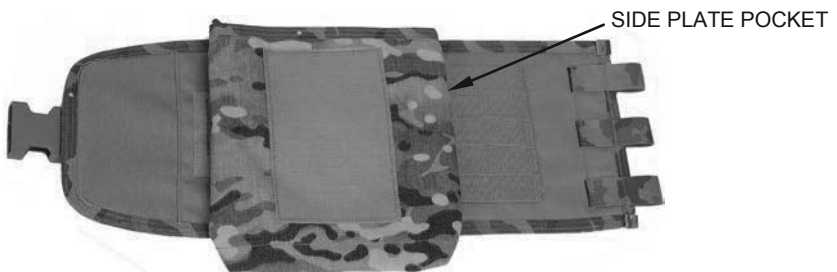

Figure 6. Side Plate Carrier (Interior) with Pocket.

LOCATION AND DESCRIPTION OF MAJOR COMPONENTS – CONTINUED

Vest Assembly – Continued

Yoke/Collar Assembly. The yoke/collar assembly (Figure 7 and 8) comes in two separate pieces: front and back. These attach to the front and back carriers. The yoke/collar assembly provides additional ballistic protection to the neck and shoulders.

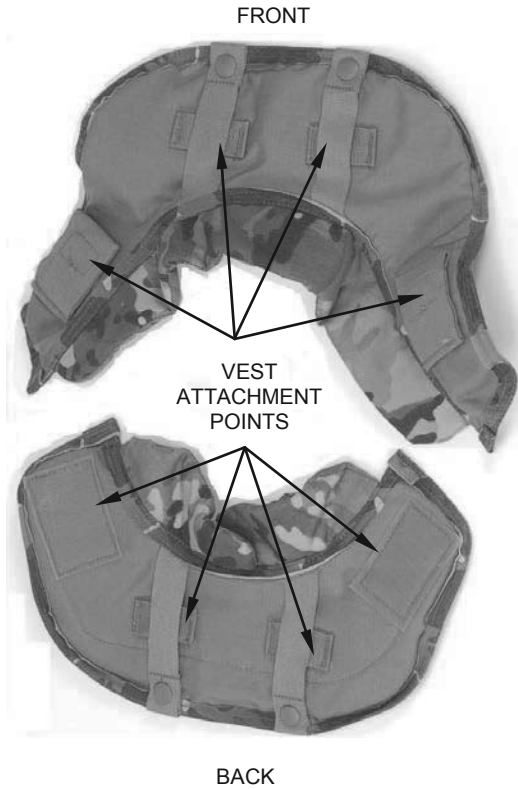

Figure 7. Yoke/Collar Assembly (Exterior).

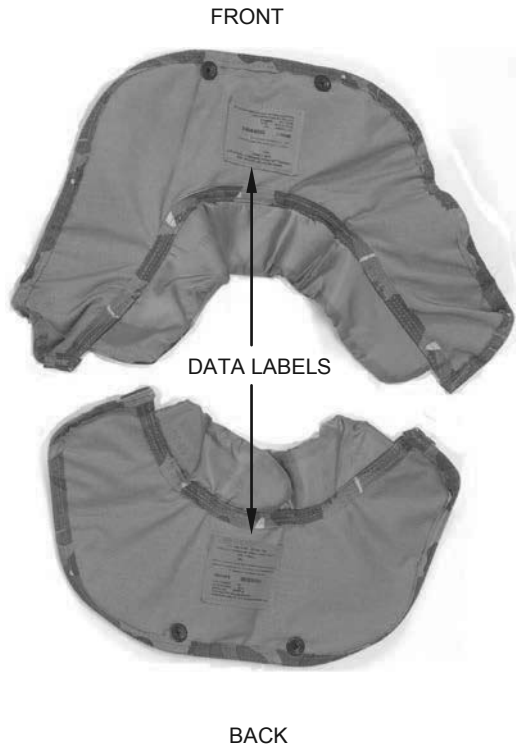

Figure 8. Yoke/Collar Assembly (Interior).

LOCATION AND DESCRIPTION OF MAJOR COMPONENTS – CONTINUED**Vest Assembly – Continued**

Emergency Release Assembly. The emergency release assembly (Figure 9) comes in one size and is installed in the front carrier. The assembly includes a webbing strap (Figure 9, Item 1) as an emergency release handle and a base plate (Figure 9, Item 2) with four cables (Figure 9, Item 3) attached.

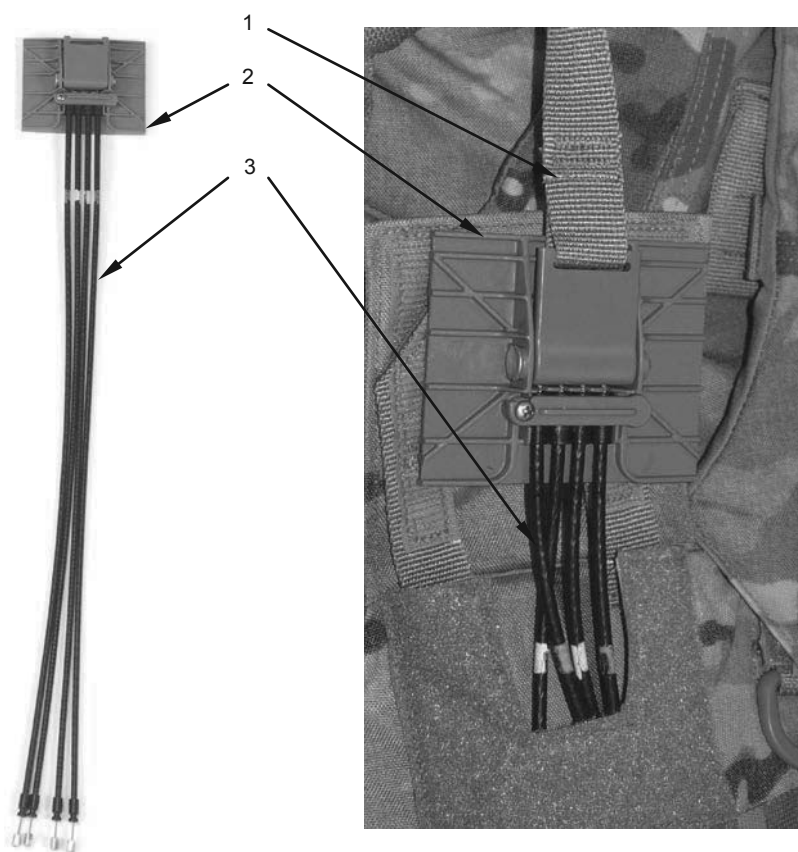

Figure 9. Emergency Release Assembly.

LOCATION AND DESCRIPTION OF MAJOR COMPONENTS – CONTINUED**Vest Assembly – Continued****Emergency Release Assembly – Continued.**

When the emergency release strap is pulled (Figure 10, Item 1), the emergency release function is activated and the vest assembly completely detaches and falls away. The emergency release strap lays under the access panel (Figure 10, Item 2) and on top of the emergency release base plate reinforcement (the U-shaped webbing) (Figure 10, Item 3).

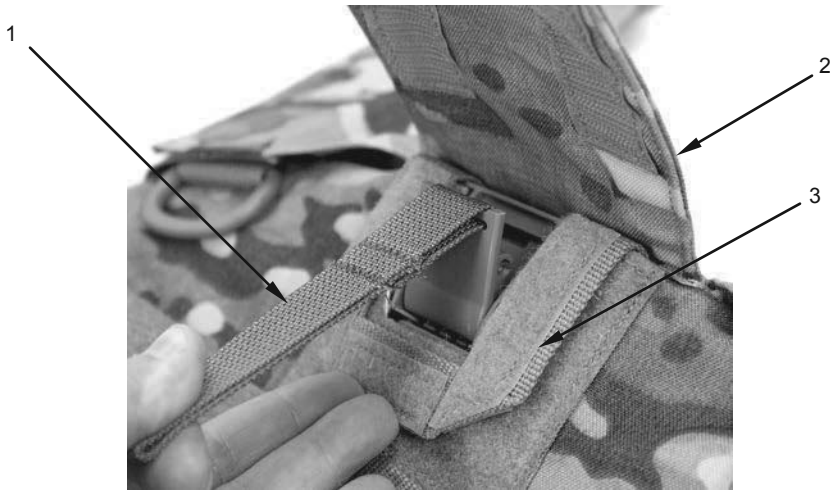

Figure 10. Emergency Release Strap.

The two outermost cables of the assembly (labeled with magenta tape) are installed in the male ends of the buckles at the shoulders of the front carrier. The two innermost cables (labeled with white tape) are installed in the male ends of the buckles under the bottom panel of the front carrier (Figure 11).

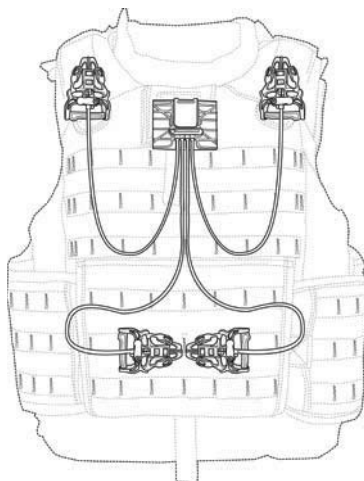

Figure 11. Emergency Release Cable Connections.

LOCATION AND DESCRIPTION OF MAJOR COMPONENTS – CONTINUED**Ancillary Equipment**

The ballistic protection for the IBA vest assembly can be extended with ancillary equipment. Ancillary equipment for the IOTV Gen III includes deltoid protectors, groin protector, and lower back protector.

Each item of ancillary equipment consists of a soft ballistic insert inside a carrier component. The groin protector also has a firm plastic insert.

Lower Back Protector. The lower back protector (Figures 12 and 13) provides additional protection for the lower spine and pelvis. The lower back protector attaches to the inside of the back carrier using two nylon straps and snap fasteners.

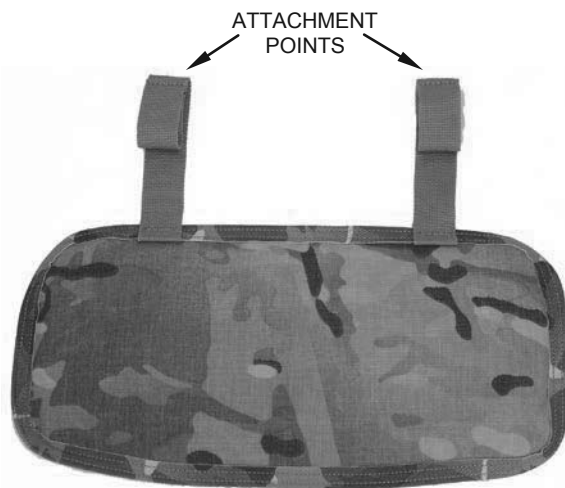

Figure 12. Lower Back Protector (Exterior).



Figure 13. Lower Back Protector (Interior).

LOCATION AND DESCRIPTION OF MAJOR COMPONENTS – CONTINUED**Ancillary Equipment – Continued**

Deltoid Protectors. The deltoid protectors (Figure 14 and 15) provide additional ballistic protection to the shoulders and upper arms. They attach to the shoulder sections of the vest and use nylon webbing straps to keep the protectors wrapped around the arm.



Figure 14. Deltoid Protectors (Exterior).

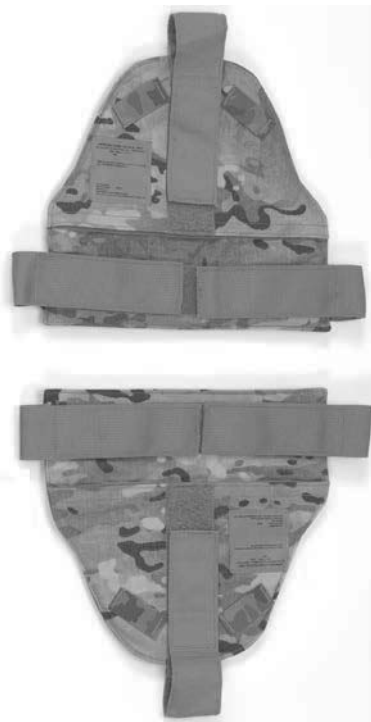

Figure 15. Deltoid Protectors (Interior).

LOCATION AND DESCRIPTION OF MAJOR COMPONENTS – CONTINUED

Ancillary Equipment – Continued

Groin Protector. The groin protector (Figures 16 and 17) is worn on the ACU trouser and provides additional protection to the femoral arteries and pelvis. It is a new design for the IOTV Gen III and is attached to the front carrier for storage only. The attachment straps are tucked into the groin protector carrier when not attached to the front carrier.

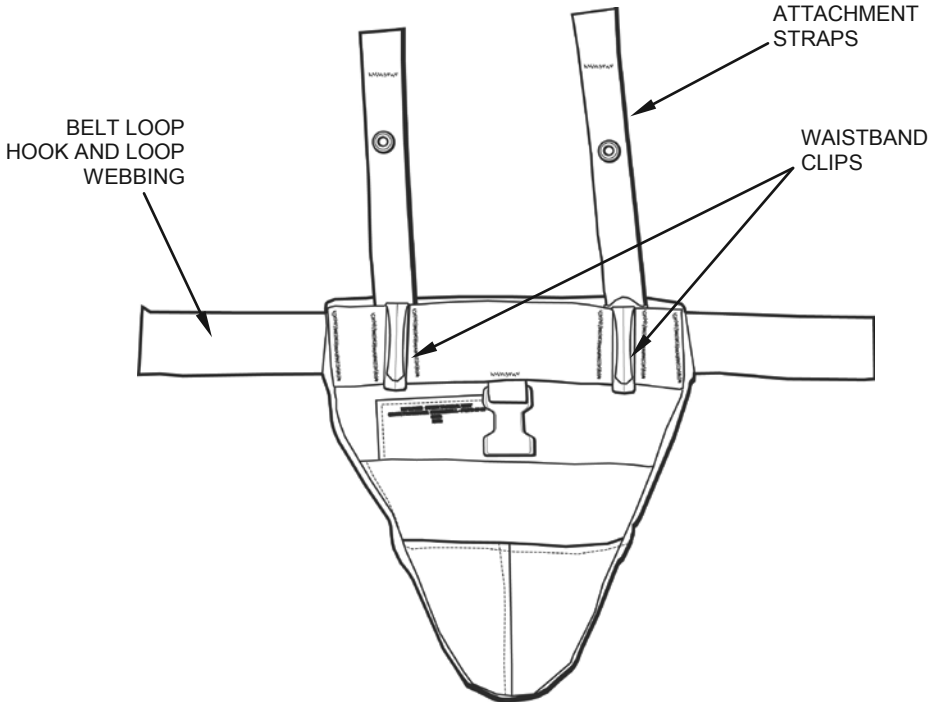

Figure 16. Groin Protector (Interior).



Figure 17. Groin Protector (Exterior).

LOCATION AND DESCRIPTION OF MAJOR COMPONENTS – CONTINUED**Hard Armor**

There are two types of hard armor plates: Small Arms Protective Inserts (SAPI) and Side Ballistic Inserts (SBI). Both SAPI and SBI are worn with the concave side (data label side) toward the body.

SAPI – The Enhanced Small Arms Protective Inserts (ESAPI) have green covers (Figure 18) and provide protection for the chest and back against 7.62 mm bullets. The X Small Arms Protective Inserts (XSAPI) have tan covers and provide greater protection than the ESAPI for the chest and back.

SBI – The Enhanced Side Ballistic Inserts (ESBI) have green covers and provide side protection against 7.62 mm bullets. The X Side Ballistic Inserts (XSBI) have tan covers and provide greater side protection than the ESBI.



Figure 18. Interior and Exterior Faces of ESAPI.

DIFFERENCES BETWEEN MODELS

The IOTV Gen III has the ability to accept SAPI plates one size larger than the vest size (back carrier only), an improved groin protector, and a new emergency release assembly system which, when activated, fully discharges the vest assembly.

The lower back protector, deltoid protectors, side plate pockets, and ballistics for the front and back carriers are fully interchangeable with the IOTV Gen II components of the same size.

Vest Assembly

Front Carrier. The IOTV Gen III front carrier (Figure 19) has equipment attachment rings at the left and right shoulders designed for attaching the Tactical Assault Panel (TAP) or other equipment and buckles for attaching the side plate carrier.



Figure 19. IOTV Gen III Assembly (Front View).

DIFFERENCES BETWEEN MODELS - CONTINUED

Back Carrier. The IOTV Gen III back carrier (Figure 20) has two shoulder straps with buckles to which the front carrier attaches. There are two access panels. The upper access panel provides access to the pockets for the hard armor and the large, lower panel provides access to the adjustment points for fitting the side plate carrier.

Emergency Release Assembly. The IOTV Gen III emergency release assembly provides a single activation point instead of a draw cord as with earlier IOTV models.

Side Plate Carriers. The IOTV Gen III vest has a left and a right side plate carrier with side plate pockets to hold the SBI plates. The side plate carriers and pockets for the IOTV Gen III are universal and the pockets are removable. The IOTV Gen III universal side plate carriers also have a stiff plastic liner that provides extra support.

Groin Protector. The groin protector provides additional protection to the femoral arteries and pelvis and is worn on the belt loops of the ACU trouser. The attachment loops tuck into the groin protector carrier when not attached to the front carrier.



Figure 20. IOTV Gen III Assembly (Back View).

EQUIPMENT DATA**Component** **Data****Vest**

Sizes..... XS, S, M, ML, L, LL, XL, XLL, 2XL, 3XL, 4XL
 Protection9 mm, Fragmentation

Universal Side Plate Carriers

Sizes..... XS-S, M-L, XL-2XL, 3XL-4XL

Universal Side Plate Pocket

Sizes..... One Size

Emergency Release Assembly

Sizes..... One Size

Yoke/Collar Assembly

Sizes (Front)..... XS, S, M, L, XL, 2XL, 3XL, 4XL
 Sizes (Back)..... XS, S, M, L, XL, 2XL, 3XL, 4XL
 Protection Fragmentation

Groin Protector

Sizes..... S-ML, L-4XL
 Protection9 mm, Fragmentation

Lower Back Protector

Sizes..... One size
 Protection9 mm, Fragmentation

Deltoid Protectors

Sizes..... XS-S, M-L, XL-4XL
 Protection9 mm, Fragmentation

Enhanced Side Ballistic Inserts (ESBI)

Sizes..... One Size

Enhanced Small Arms Protective Inserts (ESAPI)

Sizes..... XS, S, M, L, XL

X Side Ballistic Inserts (XSBI)

Sizes..... One Size

X Small Arms Protective Inserts (XSAPI)

Sizes..... XS, S, M, L, XL

EQUIPMENT DATA - CONTINUED

System Weight

Table 1. IOTV Gen III System Weight Chart (in pounds).

| Finished Component | XS | S | M | ML | L | LL | XL | XLL | 2XL | 3XL | 4XL |
|--|--------------|--------------|--------------|--------------|--------------|--------------|--------------|--------------|--------------|--------------|--------------|
| Base Vest Assembly: outer base, vest carrier, 2 ballistic panels | 9.46 | 9.76 | 10.37 | 11.10 | 11.50 | 11.75 | 12.53 | 13.04 | 14.00 | 16.25 | 16.55 |
| Front Yoke/ Collar Assembly | 0.65 | 0.66 | 0.70 | 0.70 | 0.72 | 0.72 | 0.72 | 0.72 | 0.76 | 0.76 | 0.76 |
| Back Yoke/Collar Assembly | 0.60 | 0.60 | 0.63 | 0.63 | 0.63 | 0.63 | 0.70 | 0.70 | 0.73 | 0.76 | 0.76 |
| Groin Protector Assembly | 0.92 | 0.92 | 0.92 | 0.92 | 1.10 | 1.10 | 1.10 | 1.10 | 1.10 | 1.10 | 1.10 |
| Lower Back Protector Assembly | 0.60 | 0.60 | 0.60 | 0.60 | 0.60 | 0.60 | 0.60 | 0.60 | 0.60 | 0.60 | 0.60 |
| Deltoid Protectors (2) | 1.91 | 1.91 | 2.28 | 2.28 | 2.28 | 2.28 | 2.76 | 2.76 | 2.76 | 2.76 | 2.76 |
| Total System Weight | 14.14 | 14.43 | 15.50 | 16.23 | 16.83 | 17.08 | 18.41 | 18.91 | 19.94 | 22.22 | 22.52 |

Table 2. Hard Armor Ballistic Inserts Weight Chart (in pounds).

| | | | | | | | | | | | |
|-------------------|------|-------|-------|-------|-------|-------|-------|-------|-------|-------|-------|
| ESBI Plates (x2) | 5.10 | 5.10 | 5.10 | 5.10 | 5.10 | 5.10 | 5.10 | 5.10 | 5.10 | 5.10 | 5.10 |
| ESAPI Plates (x2) | 7.60 | 9.50 | 10.90 | 10.90 | 12.50 | 12.50 | 14.20 | 14.20 | 14.20 | 14.20 | 14.20 |
| XSBI Plates (x2) | 6.0 | 6.0 | 6.0 | 6.0 | 6.0 | 6.0 | 6.0 | 6.0 | 6.0 | 6.0 | 6.0 |
| XSAPI Plates (x2) | 8.36 | 10.46 | 12.00 | 12.00 | 13.76 | 13.76 | 15.62 | 15.62 | 15.62 | 15.62 | 15.62 |

END OF WORK PACKAGE

**OPERATOR MAINTENANCE
IMPROVED OUTER TACTICAL VEST GEN III
THEORY OF OPERATION**

THEORY OF OPERATION

Different field scenarios require different levels of protection for the Soldier. Unit commanders will prescribe the level of protection required for a mission.

The most basic configuration of the IOTV Gen III vest assembly consists of the front and back carriers with soft ballistic inserts, two side plate carriers with side plate pockets, yoke/collar assembly, and the emergency release assembly.

The ancillary equipment provides protection for areas not covered by the basic configuration. The deltoid protectors provide protection for the shoulders and upper arms. The groin protector provides protection for the femoral arteries and pelvis. The lower back protector provides protection for the lower spine and pelvis.

The next level of protection is hard armor plates in addition to the soft ballistic inserts in the front and back carriers of the vest assembly. Ensure the soft ballistic protection remains flat and smooth in the carriers, and insert the side ballistic plates in the side plate pockets.

Interceptor body armor (IBA) is designed to protect the service member from small-arms fire to include 7.62 mm and 9 mm bullets as well as fragmentation.

Emergency Release Function

The IOTV Gen III vest has a quick release function designed to be used during emergency situations only. When the IOTV Gen III is assembled with some or all of the ancillary equipment, the quick release function can be used to doff the vest rapidly in emergency situations. Such situations could include quick access for medical attention or removing the vest quickly to swim.

Once the function has been used, the vest can be reassembled easily to provide ballistic protection.

END OF WORK PACKAGE

CHAPTER 2

OPERATOR INSTRUCTIONS
FOR
IMPROVED OUTER TACTICAL VEST GEN III
(IOTV GEN III)

OPERATOR MAINTENANCE
IMPROVED OUTER TACTICAL VEST GEN III
DESCRIPTION AND USE OF OPERATOR CONTROLS AND INDICATORS

The Interceptor Body Armor (IBA) system is a modular system that consists of a vest assembly, hard armor, and ancillary equipment that increases the area of coverage and level of protection.

There are no controls or indicators for this equipment.

END OF WORK PACKAGE

OPERATOR MAINTENANCE
IMPROVED OUTER TACTICAL VEST GEN III
OPERATION UNDER USUAL CONDITIONS – ASSEMBLY AND
PREPARATION FOR USE

INITIAL SETUP**References**

WP 0002
WP 0007
WP 0010

ASSEMBLY AND PREPARATION FOR USE

The Interceptor Body Armor (IBA) system must be sized properly to protect the Soldier from ballistic threats. Verify that each component of the system is the correct size before assembling it for use.

Inventory**NOTE**

With the exception of the groin protector, all components and ancillary equipment for the IOTV Gen III are compatible with the components and ancillary equipment for the IOTV Gen II. When conducting inventory, any combination of components will make up a system as long as all components are present and sized properly.

1. Inventory the system using Table 1.
 - a. The first column lists the name of the component to be inventoried.
 - b. The second column indicates the quantity of that item required to make a complete IBA system for the IOTV Gen III configuration.
 - c. The third column has pictures of each component for the IOTV Gen III.





NOTE

The following table shows pictures of each component for easy identification. Refer to WP 0002 for more details.

ASSEMBLY AND PREPARATION FOR USE – CONTINUED

Inventory – Continued

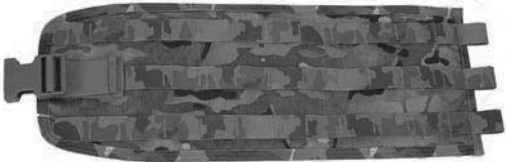





Table 1. IOTV Gen III Inventory.

| Component | QTY | IOTV Gen III |
|-----------------------------|-----|---|
| Front Vest Carrier | 1 |  |
| Front Soft Ballistic Insert | 1 |  |
| Back Vest Carrier | 1 |  |
| Back Soft Ballistic Insert | 1 |  |

ASSEMBLY AND PREPARATION FOR USE – CONTINUED

Inventory – Continued

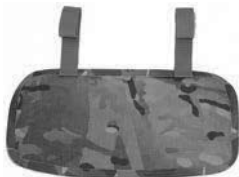





Table 1. IOTV Gen III Inventory – Continued.

| Component | QTY | IOTV Gen III |
|--|-----|---|
| Side Plate Carrier | 2 |  |
| Detachable Side Plate Pocket | 2 |  |
| Front Yoke/Collar | 1 |  |
| Back Yoke/Collar | 1 |  |
| Groin Protector Carrier | 1 |  |
| Groin Protector Soft Ballistic Insert and Plastic Insert | 1 |  |

ASSEMBLY AND PREPARATION FOR USE – CONTINUED

Inventory – Continued



Table 1. IOTV Gen III Inventory – Continued.

| Component | QTY | IOTV Gen III |
|--|-----|---|
| Lower Back Protector Carrier | 1 |  |
| Lower Back Protector Soft Ballistic Insert | 1 |  |
| Deltoid Protector Carrier | 2 |  |
| Deltoid Protector Soft Ballistic Insert | 2 |  |
| SBI Plate | 2 | <div style="display: flex; justify-content: space-around; align-items: center;"> <div style="text-align: center;">  <p>Interior (body) side with data label</p> </div> <div style="text-align: center;">  <p>Exterior side</p> </div> </div> |

ASSEMBLY AND PREPARATION FOR USE – CONTINUED

Inventory – Continued

Table 1. IOTV Gen III Inventory – Continued.

| Component | QTY | IOTV Gen III | |
|------------|-----|---|---|
| SAPI Plate | 2 |  <p>Interior (body) side with data label</p> |  <p>Exterior side</p> |

2. Check the interior side of each component for a data label.
3. Confirm each component is the correct size for your system as indicated in Table 2.
 - a. Find the vest size of your IOTV Gen III on the top row of Table 2.
 - b. Locate each component in the first column of Table 2.
 - c. The correct size for each component is specified at the intersection of the row for the component and the column for the vest size.

Table 2. IOTV Gen III Component Sizing Chart.

| Vest Size | XS | S | M | ML | L | LL | XL | XLL | 2XL | 3XL | 4XL |
|--|------|------|------|------|------|------|--------|--------|--------|---------|---------|
| Front Carrier & Soft Ballistic Insert | XS | S | M | ML | L | LL | XL | XLL | 2XL | 3XL | 4XL |
| Back Carrier & Soft Ballistic Insert | XS | S | M | ML | L | LL | XL | XLL | 2XL | 3XL | 4XL |
| Back Carrier & SAPI Plate | XS-S | S-M | M-L | M-L | L-XL | L-XL | XL | XL | XL | XL | XL |
| Side Plate Carriers | XS-S | XS-S | M-LL | M-LL | M-LL | M-LL | XL-2XL | XL-2XL | XL-2XL | 3XL-4XL | 3XL-4XL |
| Universal Side Plate Pockets | U | U | U | U | U | U | U | U | U | U | U |

ASSEMBLY AND PREPARATION FOR USE – CONTINUED

Inventory – Continued

Table 2. IOTV Gen III Component Sizing Chart – Continued.

| Vest Size | XS | S | M | ML | L | LL | XL | XLL | 2XL | 3XL | 4XL |
|---|-----------|----------|----------|-----------|----------|-----------|-----------|------------|------------|------------|------------|
| Front Yoke/Collar | XS | S | M-ML | M-ML | L-LL | L-LL | XL-XLL | XI-XXL | 2XL | 3XL | 4XL |
| Back Yoke/Collar | XS | S | M-ML | M-ML | L-LL | L-LL | XL-XLL | XI-XXL | 2XL | 3XL | 4XL |
| Groin Protector & Soft Ballistic Insert | XS-ML | XS-ML | XS-ML | XS-ML | L-4XL | L-4XL | L-4XL | L-4XL | L-4XL | L-4XL | L-4XL |
| Lower Back Protector & Soft Ballistic Insert | U | U | U | U | U | U | U | U | U | U | U |
| Deltoid Protectors & Soft Ballistic Inserts | XS-S | XS-S | M-L | M-L | M-L | M-L | XL-4XL | XL-4XL | XL-4XL | XL-4XL | XL-4XL |
| ESAPI Plates | XS | S | M | M | L | L | XL | XL | XL | XL | XL |
| ESBI Plates | U | U | U | U | U | U | U | U | U | U | U |
| XSAPI Plates | XS | S | M | M | L | L | XL | XL | XL | XL | XL |
| XSBI Plates | U | U | U | U | U | U | U | U | U | U | U |

4. If a component is not the correct size or if it does not have a data label, turn it in for a properly sized component.
5. Inspect each component using Table 1, WP 0010, Preventive Maintenance Checks and Services.

END OF TASK

ASSEMBLY AND PREPARATION FOR USE – CONTINUED

Assemble IOTV Gen III

WARNING

Confirm that sizes of the front and back vest carriers match by comparing data label information. Ensure the sizes of the attachable components match the sizes of the front and back vest carriers by comparing information on the data label. Failure to do so could affect performance, causing injury or death to personnel.

NOTE

The term interior fabric or interior surface is the side of any component of the IBA system that faces the Soldier when worn. The term exterior fabric or exterior surface is the side of any component of the IBA system that faces away from the Soldier.

The term inside surface, inside fabric or inside is the area of any IBA component that is between the exterior and interior surfaces. The inside or inside surface of an IBA component is the portion that touches the soft ballistic inserts.

Inserting Soft Ballistics

1. Place the front vest carrier on a clean surface with the exterior surface facing down (Figure 1).



Figure 1. Front Vest Carrier with Exterior Facing Down.

2. Place the soft ballistic insert on a clean surface with the data label facing up.

ASSEMBLY AND PREPARATION FOR USE – CONTINUED**Assemble IOTV Gen III – Continued****Inserting Soft Ballistics – Continued.**

3. Fold the sides and then the shoulders in toward the center (Figure 2).



Figure 2. Soft Ballistic Inserts Folded.

4. Separate the hook and loop fastener tape on the interior fabric of the carrier.

NOTE

When inserting ballistics into the carriers, the correct placement is data label to data label. The label of the ballistic faces the label of the carrier.

5. Place soft ballistics inside the carrier (Figure 2).
6. Using your hand, smooth the soft ballistic insert so that it fits snugly inside the carrier and does not bulge or fold (Figure 3 (Actual vest material is not see-through.)).



Figure 3. Flatten Soft Ballistics.

ASSEMBLY AND PREPARATION FOR USE – CONTINUED**Assemble IOTV Gen III – Continued****Inserting Soft Ballistics – Continued.**

7. Reseal the hook and loop fastener tape, ensuring that the tape and fabric are smooth and have no folds or puckers.
8. Place the back vest carrier on a clean surface with the exterior surface facing down.
9. Place the soft ballistic insert on a clean surface with the data label facing up.
10. Fold the sides and then the shoulders in toward the center.
11. Separate the hook and loop fastener tape on the interior fabric of the carrier.
12. Place soft ballistics inside the carrier.
13. Using your hand, smooth the soft ballistic insert so that it fits snugly inside the carrier and does not bulge or fold.
14. Reseal the hook and loop fastener tape, ensuring that the tape and fabric are smooth and have no folds or puckers.
15. Place the lower back protector carrier on a clean, flat surface with the exterior surface facing down.
16. Place the soft ballistic insert on a clean surface with the data label facing up.
17. Separate the hook and loop fastener tape to the ballistic compartment of the carrier, and insert the soft ballistics inside the carrier (Figure 4).



Figure 4. Lower Back Protector Carrier with Ballistic Insert.

18. Use your hand to smooth the inserts and ensure that there are no folds or bulges, and reseal the hook and loop tape.

ASSEMBLY AND PREPARATION FOR USE – CONTINUED**Assemble IOTV Gen III – Continued****Inserting Soft Ballistics – Continued.**

19. Repeat steps 15 through 19 for the deltoid protector carrier.



Figure 5. Deltoid Protector Carrier with Ballistic Insert.

20. Place the groin protector carrier on a clean surface with the exterior facing up and the label side facing down (Figure 6).



Figure 6. Groin Protector Carrier.

21. Place the soft ballistic insert on a clean surface with the data label facing down.

ASSEMBLY AND PREPARATION FOR USE – CONTINUED**Assemble IOTV Gen III – Continued****Inserting Soft Ballistics – Continued.**

22. Open the cover flap at the top of the groin protector carrier.
23. Insert the soft ballistic insert with the label facing the body.
24. Place the plastic insert between the exterior surface of the groin protector carrier and the soft ballistic insert with the curve facing the body (Figure 7).



Figure 7. Plastic and Soft Ballistic Inserts in Groin Protector Carrier.

25. Secure the hook and loop tape at the top of the opening.

END OF TASK**Inserting Hard Armor Plates**

1. Place the front vest carrier on a clean surface with the exterior surface facing down.
2. Separate the hook and loop fastener tape on the interior fabric of the carrier.

ASSEMBLY AND PREPARATION FOR USE – CONTINUED**Assemble IOTV Gen III – Continued****Inserting Hard Armor Plates**

3. Lift the soft ballistic insert to reveal the hard armor pocket (Figure 8, Item 1).



Figure 8. Hard Armor Pocket in Front Vest Carrier.

4. Unfasten the nylon strap at the bottom of the hard armor pocket (Figure 8, Item 2).
5. Ensure that the emergency release cables are laying flat inside the compartment.
6. Place SAPI into the hard armor pocket with the data label-side facing up (Figure 9).



Figure 9. Hard Armor in Front Vest Carrier.

7. Push the plate all the way up inside the vest until it is even with the bottom of the plate pocket.

ASSEMBLY AND PREPARATION FOR USE – CONTINUED

Assemble IOTV Gen III – Continued

Inserting Hard Armor Plates – Continued.

8. Securely attach the hook and loop strap to hold the plate firmly in place (Figure 10).



Figure 10. Hard Armor Pocket Closed.

9. Smooth the soft ballistic inserts inside the carrier, ensuring there are no folds or buckles, and close the vest opening.
10. Reseal the hook and loop fastener tape on the interior of the carrier, ensuring there are no folds or puckers.
11. Place the back vest carrier on a clean surface with the exterior surface facing up.

WARNING

The back carrier is designed with two pockets for hard armor plates (SAPI)—one for a SAPI that is the same size as the IOTV Gen III and one for a SAPI that is the next size larger than the IOTV Gen III. Both pockets are accessed by the same exterior panel.

The pocket closest to the exterior of the back carrier is the smaller of the two and designed to carry a SAPI that is the same size as the vest assembly. The pocket closest to the body is designed to carry a SAPI that is the next size larger than the back carrier.

Ensure that the SAPI fits snugly in the pocket into which it is inserted. Failure to do so could adversely affect the protection provided, causing injury or death to the service member.

ASSEMBLY AND PREPARATION FOR USE – CONTINUED**Assemble IOTV Gen III – Continued****Inserting Hard Armor Plates – Continued.**

12. Separate the hook and loop fastener tape of the top access panel just below the drag strap (Figure 11).

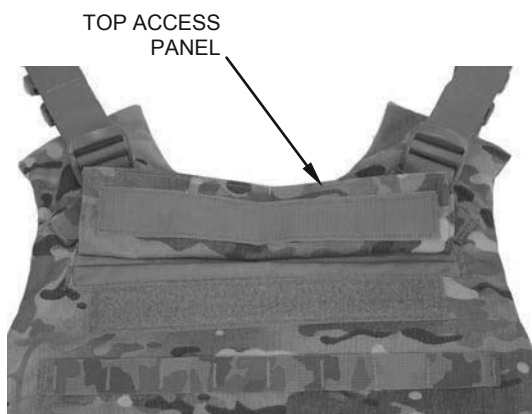

Figure 11. Top Access Panel Open.

13. Compare the size on the data label of the hard armor plate to the size on the data label of the back carrier.
 - a. If the SAPI is the same size as the back carrier,
 - (1) Separate the hook and loop tape sealing pocket 1 (the pocket closest to the exterior of the carrier and the smaller of the two) (Figure 9).
 - (2) Insert the SAPI with the data label side down.
 - (3) Ensure the plate is even with the top of the pocket opening.
 - (4) Reseal the hook and loop fastener tape to the interior pocket, ensuring there are no folds or puckers.
 - (5) Reseal the hook and loop fastener tape of the top access panel.

ASSEMBLY AND PREPARATION FOR USE – CONTINUED**Assemble IOTV Gen III – Continued****Inserting Hard Armor Plates – Continued.**

- b. If the SAPI is the next size larger than the carrier,
 - (1) Insert the SAPI with the data label side down in pocket 2 (the pocket closest to the body and the larger of the two pockets) (Figure 12).
 - (2) Ensure the plate is even with the top of the pocket opening.
 - (3) Reseal the hook and loop fastener tape on the exterior of the carrier, ensuring there are no folds or puckers.

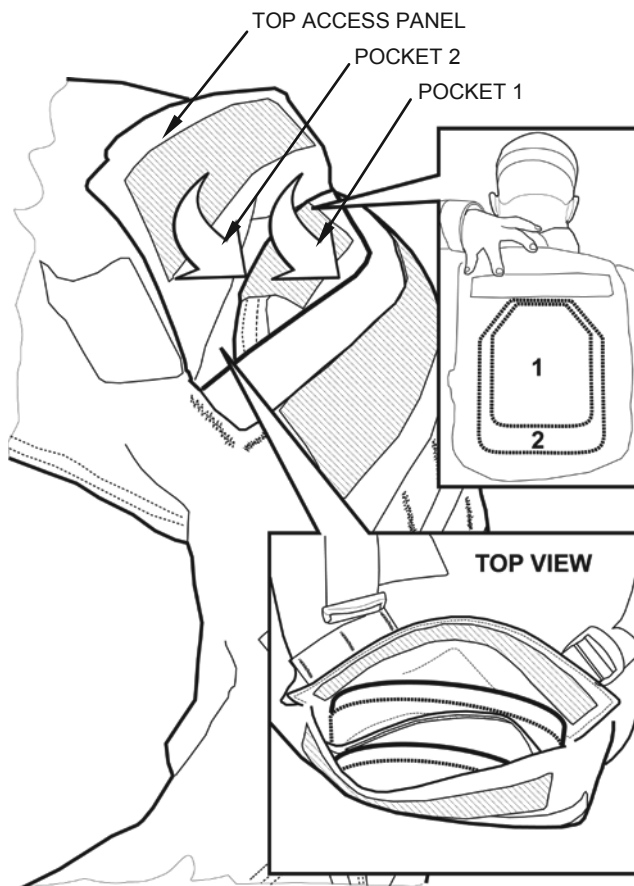

Figure 12. Additional Pockets for Hard Armor.

END OF TASK

ASSEMBLY AND PREPARATION FOR USE – CONTINUED**Assemble IOTV Gen III – Continued****Installing Yoke/Collar Assembly**

1. Place the front carrier on a flat surface with interior/label side facing up.
2. Place the front yoke/collar in line with the carrier with the label side facing up.
3. Separate the hook and loop holding the 2-inch webbing straps on the exterior side of the yoke/collar.
4. Insert the two straps into the webbing tabs located at the top of the shoulders on the carrier, and reattach the strap to the hook and loop on the yoke/collar (Figure 13).



Figure 13. Webbing Straps on Yoke/Collar Assembly.

5. Thread the two lower straps through the webbing tabs on the carrier (Figure 14).



Figure 14. Lower Straps Threaded.

ASSEMBLY AND PREPARATION FOR USE – CONTINUED**Assemble IOTV Gen III – Continued****Installing Yoke/Collar Assembly – Continued.**

6. Snap the straps to the yoke/collar and check for proper alignment along the neck opening (Figure 15).



Figure 15. Front Yoke/Collar Aligned.

7. Place the back carrier on a flat surface with interior/label side facing up.
8. Align and connect the hook and loop fasteners on the back yoke/collar with the back carrier (Figure 16).



Figure 16. Hook and Loop Aligned.

ASSEMBLY AND PREPARATION FOR USE – CONTINUED**Assemble IOTV Gen III – Continued****Installing Yoke/Collar Assembly – Continued.**

9. Thread the two straps through the webbing tabs on the carrier.
10. Weave the straps back through the webbing tabs on the yoke/collar (Figure 17).



Figure 17. Straps on Back of Yoke/Collar.

11. Snap the straps to the yoke/collar.
12. Adjust the hook and loop fasteners between the front carrier and the yoke/collar for proper alignment along the neck opening (Figure 18).



Figure 18. Back Yoke/Collar Aligned.

END OF TASK

ASSEMBLY AND PREPARATION FOR USE – CONTINUED

Assemble IOTV Gen III – Continued

Installing Side Plate Carrier Pockets

1. Place the side plate carriers on a clean, smooth surface with the label side facing up (Figure 19).

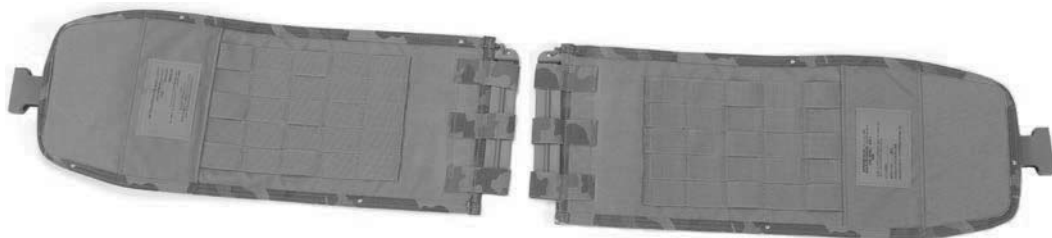

Figure 19. Side Plate Carriers.

NOTE

The side plate carriers and side plate pockets are universal and can be used for either the left or right sides until assembled. Before attaching the pockets identify the left and right sides for each. The pocket opening should be facing up. Maintain the correct orientation when attaching the side plate carrier to the front and back vests.

2. Specify the side plate pockets and side plate carriers as left and right side.
3. Place the pocket on the side plate carrier with the data label facing down and the pocket opening at the top, and position the pocket on the side plate carrier to give maximum protection (Figure 20).



Figure 20. Right Side Plate Carrier with Side Plate Pocket.

ASSEMBLY AND PREPARATION FOR USE – CONTINUED**Assemble IOTV Gen III – Continued****Installing Side Plate Carrier Pockets – Continued.****NOTE**

The pouch attachment ladder system (PALS) on the side plate carrier and the side plate pocket provides the flexibility to fasten the pocket in the best position on the side plate carrier.

4. Weave the webbing straps on the side plate pocket through the PALS of the side plate carrier and at least one row of the PALS on the side plate pocket (Figure 21).



Figure 21. PALS on Side Plate Pocket and Carrier.

5. Snap the webbing straps to the side plate pocket.
6. Open the side plate pocket by separating the hook and loop tape and pulling out the flap.
7. Either the SBI or an extra small SAPI may be used with the side plate pocket.
 - a. If using the SBI
 - (1) Insert the SBI into the pocket with the label facing the label side of the pocket on the interior/body side.
 - (2) Fold the flap of the pocket down and tuck it inside the pocket.

ASSEMBLY AND PREPARATION FOR USE – CONTINUED**Assemble IOTV Gen III – Continued****Installing Side Plate Carrier Pockets – Continued.**

- b. If using the extra-small SAPI,
 - (1) Slide the extra-small SAPI into the pocket bottom first with the label facing the label side of the pocket on the interior/body side.
 - (2) Carefully slide the upper flap over the top of the SAPI (Figure 22).



Figure 22. Pocket Flap Over SAPI.

8. Follow steps 6 and 7 to install the hard armor in the second pocket.

END OF TASK**Installing Side Plate Carriers**

1. Place the side plate carriers on a flat surface with the label side facing down.
2. Place the back carrier on a flat surface with the label side facing down.

ASSEMBLY AND PREPARATION FOR USE – CONTINUED**Assemble IOTV Gen III – Continued****Installing Side Plate Carriers – Continued.**

3. Lift up the lower panel on the exterior of the back carrier with the webbing strap to expose the attachment points for the side plate carrier.

NOTE

The girth of the side plate carrier is adjusted with webbing hangers threaded through the webbing on the back carrier. Ensure the PALS side is facing up and the data label side is facing down on the side plate carrier.

4. Route the end of the side plate carrier with the three webbing loops through the corresponding wing channel of the back carrier until the loops are in line with the PALS on the back carrier.
5. Snap open the top of the webbing hanger (Figure 23).

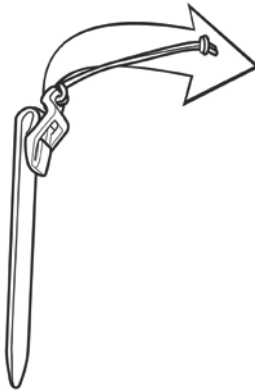

Figure 23. Webbing Hanger Snap Open.

ASSEMBLY AND PREPARATION FOR USE – CONTINUED**Assemble IOTV Gen III – Continued****Installing Side Plate Carriers – Continued.**

6. Slide the webbing hanger through the top webbing loop on the side plate carrier, through the PALS on the back carrier, and then the remaining two loops on the side plate carrier. (Figure 24).

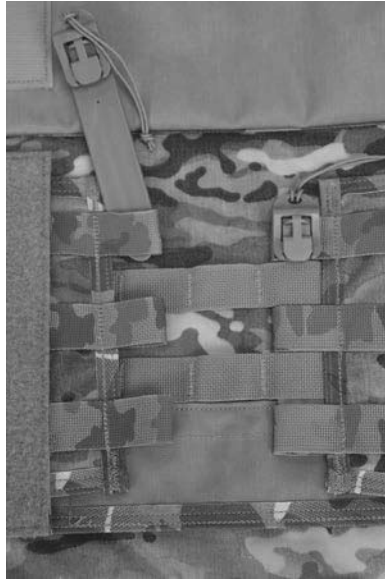

Figure 24. Webbing Hanger on Side Plate Carrier.

7. Snap the top of the webbing hanger back to close and lock it.
8. Repeat steps 13 through 16 to attach the remaining side plate carrier to the back carrier.
9. Close the back panel of the back carrier and tuck the flap up and in.
10. Try on the side plate carrier with the side plate pockets and ballistics installed to ensure that the location of the hard armor is directly under the arm and to evaluate fit in accordance with WP 0007.

END OF TASK

ASSEMBLY AND PREPARATION FOR USE – CONTINUED**Assemble IOTV Gen III – Continued****Attaching Front and Back Vests**

1. Place the front and back carriers on a flat surface with the exteriors facing up.
2. Align the front and back carriers with the exterior sides up, right shoulder to right shoulder and left shoulder to left shoulder (Figure 25).

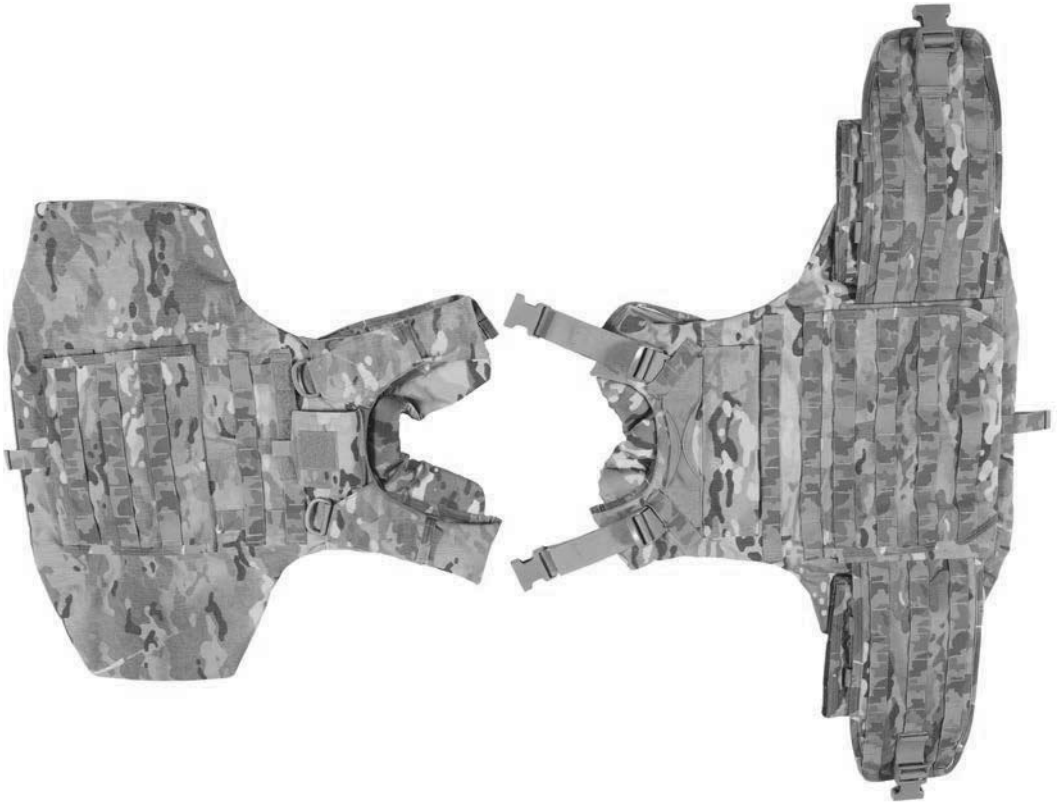

Figure 25. Front and Back Vest Carriers.

ASSEMBLY AND PREPARATION FOR USE – CONTINUED**Assemble IOTV Gen III – Continued****Attaching Front and Back Vests – Continued.**

3. Separate the hook and loop overlays at the shoulders of the front carrier (Figure 26).

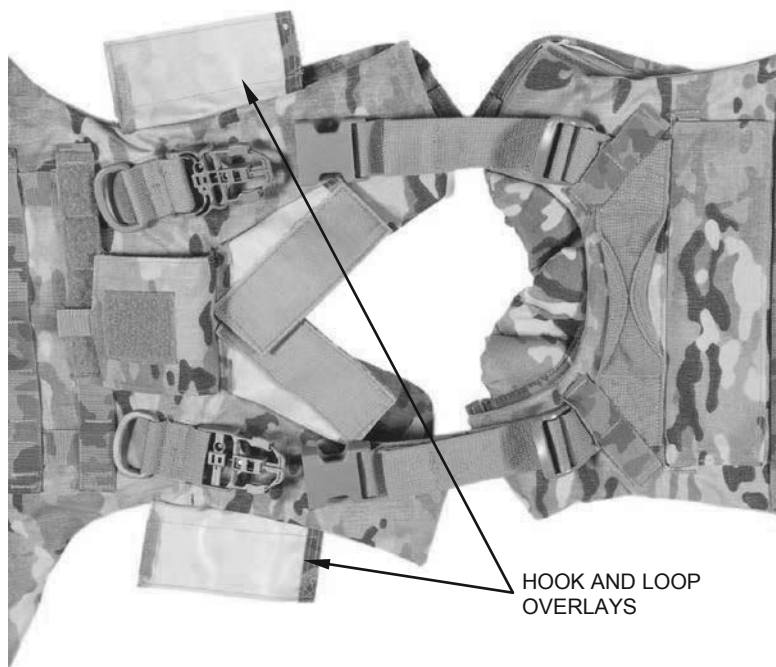

Figure 26. Shoulder Overlays Open.

4. Connect the buckles at the left and right shoulders (Figure 27).



Figure 27. Buckle at Shoulder.

ASSEMBLY AND PREPARATION FOR USE – CONTINUED

Assemble IOTV Gen III – Continued

Attaching Front and Back Vests – Continued.

5. Align and fasten the hook and loop on the left and right shoulder overlays (Figure 28).



Figure 28. Fasten Hook and Loop at Shoulder.

6. Ensure that the yoke/collar assemblies are aligned.

WARNING

Verify that the placements of the side plate pockets are still located directly under the arms to ensure maximum protection. Failure to do so could adversely affect the protection provided, causing injury or death to the service member.

7. Try on the vest assembly with the side plate carrier attached to evaluate the fit. Ensure that the side plate carrier fits snugly to the body when buckled. For additional information about evaluating and adjusting the fit, see WP 0007.

END OF TASK

Attaching Lower Back Protector

1. Place the back carrier on a flat surface with the exterior side facing down.
2. Place the lower back protector on a flat surface with the exterior side facing down and the label side facing up.

ASSEMBLY AND PREPARATION FOR USE – CONTINUED**Assemble IOTV Gen III – Continued****Attaching Lower Back Protector – Continued.**

3. Flip the lower back protector up and slide the webbing straps through the webbing on the interior back carrier.
4. Flip the lower back protector down and adjust the webbing straps to lay flush with the liner side of the back carrier (Figure 29).



Figure 29. Lower Back Protector Attached to Back Carrier.

END OF TASK

ASSEMBLY AND PREPARATION FOR USE – CONTINUED**Assemble IOTV Gen III – Continued****Attaching Deltoid Protectors****WARNING**

Do not include the flap of the back yoke/collar when attaching the deltoid protector to the carrier. Doing so may prevent the cable release from operating correctly and could affect performance, causing injury to personnel.

NOTE

Deltoid protectors are universal. There is no right or left deltoid protector.

1. Place the deltoid protector on a flat surface with the label side facing up on top of the yoke/collar and vest assembly.
2. Slide the deltoid protector upper strap between the yoke/collar at the shoulder of the vest assembly (Figure 30).



Figure 30. Attach Deltoid Protector to Vest Assembly.

ASSEMBLY AND PREPARATION FOR USE – CONTINUED**Assemble IOTV Gen III – Continued****Attaching Deltoid Protectors – Continued.**

3. Pass the strap around the shoulder of the vest assembly, and fasten it to the hook and loop on the back side of the deltoid protector (Figure 31).



Figure 31. Strap Fastened to Deltoid Protector.

4. Fold the deltoid protector over and ensure that the strap is flat and the deltoid protector exterior surface is facing up.
5. Use the same procedure for attaching both right and left deltoid protectors.
6. Secure the deltoid protector around the arm by pulling the loose end of the attachment strap around the arm and securing the hook and loop material.

END OF TASK

ASSEMBLY AND PREPARATION FOR USE – CONTINUED**Assemble IOTV Gen III – Continued****Attaching Groin Protector****WARNING**

Securely attaching the groin protector to the ACU trousers provides maximum protection (Figure 32). The groin protector of the IOTV Gen III is not designed to be attached to the front carrier except for storage purposes. Attaching the groin protector to the front vest carrier will reduce effectiveness of protection, and this may result in injury to personnel.



Figure 32. Groin Protector Attached Properly.

ASSEMBLY AND PREPARATION FOR USE – CONTINUED**Assemble IOTV Gen III – Continued****Attaching Groin Protector – Continued.**

1. Attach the two clips on the groin protector carrier to the waistband of the trousers (Figure 33).



Figure 33. Groin Protector Clipped to Trousers.

2. Thread the webbing on both sides of the groin protector through the belt loops on the trousers (Figure 34) and then fold the webbing back over, fastening the hook and loop.



Figure 34. Groin Protector Attached to Belt Loops.

END OF TASK

ASSEMBLY AND PREPARATION FOR USE – CONTINUED**Assemble IOTV Gen III – Continued****Storing Groin Protector****NOTE**

The groin protector is worn securely fastened to the waist of the ACU trouser. The attachment straps are for storing the groin protector to the front carrier and are tucked into the groin protector carrier when being worn on the trousers.

1. Place the groin protector on a flat surface with the label side facing down.
2. Place the front carrier on a flat surface with the exterior facing down and the label side facing up.
3. Flip the groin protector up and slide the webbing straps on the groin protector through the webbing on the front vest assembly (Figure 35).



Figure 35. Attach Groin Protector to Front Vest Carrier.

4. Flip the groin protector down and adjust the webbing straps to lay flush with the interior of the front carrier.
5. Ensure that the webbing straps are inserted through the buttonhole in the top of the groin protector (Figure 36).



Figure 36. Buttonhole on Groin Protector.

END OF TASK**END OF WORK PACKAGE**

OPERATOR MAINTENANCE
IMPROVED OUTER TACTICAL VEST GEN III
OPERATION UNDER USUAL CONDITIONS – DON, DOFF

INITIAL SETUP**References**

WP 0005

DON

Prior to donning your IBA, attach all the components necessary to meet mission requirements in accordance with WP 0005.

NOTE

When the IBA is worn and adjusted correctly, there will be at least ½-inch overlap of fabric where the front and back carriers join at the shoulder.

1. If both shoulder straps are connected, slip the vest assembly over your head.
2. Alternatively, disconnect one of the shoulder straps and enter the vest from the side.
3. Pull vest assembly up to ensure that the yoke/collar protects the throat.
4. Pull down on the strap to the front access panel.
5. Lift up the front panel of the front carrier to expose the side plate carrier attachment points.

WARNING

For maximum protection it is important to hold the side of the front carrier along the side of the body when pulling the side plate carrier around to the front of the body. Failure to do so will result in reduced protection and could result in injury or death to the service member.

DON – CONTINUED

6. Use one hand to hold the side of the front carrier under the arm to keep it smooth and snug, and with the other hand pull the side plate carrier towards the center of the front carrier (Figure 1).



Figure 1. Secure Side Plate Carrier.

7. Tighten or loosen the webbing strap to ensure a snug fit, and then connect the buckle.
8. Repeat for the other side.



Figure 2. Attach Side Plate Carrier.

DON – CONTINUED

9. Lower the front flap and tuck the end of the flap into the lower pocket.
10. If installed, wrap the strap of the deltoid protectors securely around your biceps.

END OF TASK**DOFF****Standard Release Method****WARNING**

Use the emergency release system for emergencies or instructional purposes only. Using the emergency release method to routinely doff the vest could result in damage to the hard armor plates. Damage to the hard armor will result in reduced protection and could cause serious injury or death to the service member.

1. If attached, remove the deltoid protector attachment straps from the arms.
2. Pull down on the strap to the front panel of the front carrier and lift the panel up.
3. Detach both buckles of the side plate carrier.
4. Lift the vest over the head, or disconnect one of the side release buckles at the shoulder and remove the vest assembly.

Emergency Release Method**NOTE**

The emergency release function is for use in emergency situations and instructional purposes only.

DOFF – CONTINUED**Emergency Release Method – Continued**

1. Locate the emergency release strap just below the neckline (Figure 1).



Figure 3. Emergency Release Strap.

WARNING

When using the emergency release function in a training or non-emergency event, do not allow the vest to fall to a solid floor. The impact may damage the hard armor plates and could compromise the effectiveness of the plates. Damage to the hard armor will result in reduced protection and could cause serious injury or death to the service member.

2. Pull the strap down. The vest assembly separates into two halves with the deltoid protectors still on your arms.
3. Allow the deltoid protectors to drop free from your arms to the ground.

END OF TASK

END OF WORK PACKAGE

OPERATOR MAINTENANCE
IMPROVED OUTER TACTICAL VEST GEN III
OPERATION UNDER USUAL CONDITIONS – EVALUATE AND ADJUST FIT

INITIAL SETUP**References**

WP 0005

WP 0006

Proper fit is achieved when the vest assembly fits snugly with no folds against the body. This ensures the vest assembly will not move around or expose unprotected areas on the operator.

EVALUATE FIT

1. Don the vest assembly in accordance with WP 0006.
2. With the side plate carriers buckled to the front carrier, evaluate the fit.
 - a. Bottom of hard armor plates in side plate pockets align as closely as possible to the bottom of the hard armor in the front carrier.
 - b. Hard armor plates in the side plate pockets are positioned directly under the arm.
 - c. The vest assembly fits securely and does not move when turning body side to side.
 - d. There is at least a ½-inch overlap of fabric where the front and back carriers join at the shoulder.
3. Note the adjustment needed, and proceed to Adjust Fit below.

END OF TASK**ADJUST FIT****Adjust Fit of Side Plate Carrier and Side Plate Pockets**

1. Place the vest assembly on a clean, flat surface with the front vest facing down.
2. Lift up the lower panel on the exterior of the back carrier with the webbing strap to expose the attachment points for the side plate carrier.

ADJUST FIT – CONTINUED**Adjust Fit of Side Plate Carrier and Side Plate Pockets – Continued**

3. Pull outward on the webbing hanger's pull cord to release the webbing lock (Figure 1).

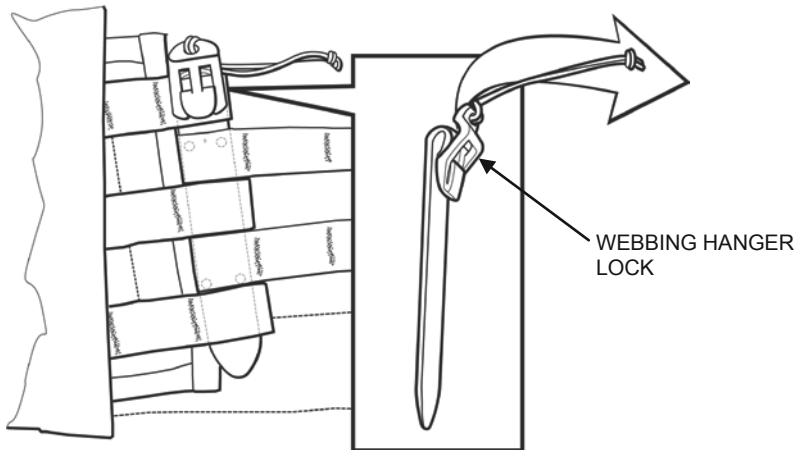

Figure 1. Webbing Hanger Lock Released.

4. Slide the webbing hanger out of the webbing loops and remove the side plate carriers from the back carrier.
5. Remove the hard armor plates from the pockets if necessary.
6. Unsnap and detach the pockets from the side plate carriers.
7. Reposition the pockets on the PALS of side plate carriers, and reattach the pockets in accordance with WP 0005.
8. Place the hard armor plates back in the pockets if necessary.
9. Route the end of the side plate carrier with the webbing loops through the corresponding wing channel of the back vest carrier until the loops are in line with the PALS on the back vest carrier.

NOTE

Adjust the position of the side plate carriers evenly on the back carrier.

10. Position the side plate carriers on the back carrier.
 - a. Tighten the fit by adjusting the side plate carriers inward.
 - b. Loosen the fit by adjusting the side plate carriers outward.
11. Rethread the webbing hanger through the webbing loops on the back carrier and side plate carriers.

ADJUST FIT – CONTINUED**Adjust Fit of Side Plate Carrier and Side Plate Pockets – Continued**

12. Snap the lock backwards at the top of the webbing hanger to close and lock it.
13. Align the hook and loop of the access panel and the back carrier,
14. Reseal the hook and loop fastener tape, ensuring that the tape and fabric are smooth and have no folds or wrinkles.
15. Tuck the bottom of the panel into the back flap pocket.
16. Don the vest and buckle the side plate carrier.
17. Adjust the webbing straps at the buckles ensuring all straps are adjusted evenly.
18. Ensure that the side plate carrier fits snugly to the body when buckled and that the side plate pockets are located directly under the arms.

Adjust Fit of Vest Assembly

1. Remove the deltoid protectors if attached.
2. Detach the hook and loop tape of the shoulder overlays on the vest assembly.

NOTE

Adjust the right and left shoulder straps evenly.

3. Pull up on the webbing straps, and either loosen or tighten the straps to get the correct fit.
4. When the vest fits firmly and comfortably on the body, ensure all straps are adjusted evenly.
5. Align and reattach the hook and loop tape on the left and right shoulder overlays.

END OF TASK

END OF WORK PACKAGE

**OPERATOR MAINTENANCE
IMPROVED OUTER TACTICAL VEST GEN III
OPERATION UNDER UNUSUAL CONDITIONS**

INITIAL SETUP**References:**FM 3-11.3

INTERCEPTOR BODY ARMOR (IBA)

The IBA is constructed to function in various temperature ranges and displays resistance to potentially caustic elements such as salt water.

Unusual Environment/Weather

Hard Armor Ballistic Inserts. The hard armor ballistic inserts are designed to be structurally and ballistically functional from -60 to 160 degrees Fahrenheit. The inserts are also designed for resistance to fluids such as oil, JP 8, and salt water.

Soft Ballistic Inserts. The soft ballistic inserts are designed to meet 97.6% of the minimum performance of a dry sample when hot or cold, and 92.7% of the minimum performance of a dry sample when wet or oil or JP 8 soaked. Extreme heat or cold does not affect the ballistic inserts.

Fording and Swimming

Swimming or fording while wearing the IOTV Gen III could be fatal because of the weight of the system. Before swimming or fording doff the IOTV Gen III by using either the normal or emergency release methods.

Interim Chemical, Biological, Radiological and Nuclear (CBRN) Decontamination Procedures

If the IBA is exposed to any Chemical, Biological, Radiological, and Nuclear (CBRN) elements dispose of it in accordance with FM 3-11.3.

END OF WORK PACKAGE

CHAPTER 3

**PREVENTIVE MAINTENANCE CHECKS
AND SERVICES
FOR
IMPROVED OUTER TACTICAL VEST GEN III
(IOTV GEN III)**

OPERATOR MAINTENANCE
IMPROVED OUTER TACTICAL VEST GEN III
PREVENTIVE MAINTENANCE CHECKS AND SERVICES (PMCS) - INTRODUCTION

INTRODUCTION

Preventive Maintenance Checks and Services (PMCS) are performed to keep clothing items in good serviceable condition and ready for issue. Pay attention to **WARNING**, **CAUTION**, and **NOTE** statements. A **WARNING** indicates that someone could be hurt or killed. A **CAUTION** indicates that equipment could be damaged. A **NOTE** may make your maintenance or repair task easier.

Be sure to perform scheduled PMCS. Always perform PMCS in the same order so it becomes habit. With practice, you will quickly recognize problems with the equipment.

Use DA Form 2404, Equipment Inspection and Maintenance Worksheet, to record any discovered faults. Do not record faults that you fix!

PMCS PROCEDURES

Table 1. Preventive Maintenance Checks and Services (PMCS). Lists inspections and care required to keep your equipment in good operating condition. It is arranged so that you can perform before operation checks as you walk around the equipment.

EXPLANATION OF PMCS TABLE COLUMNS:

Item Number. Indicates the reference number. When completing DA Form 2404, Equipment Inspection and Maintenance Worksheet, include the item number for the item to check/service indicating a fault. Item numbers appear in the order you must perform the checks/services listed.

Interval. Indicates when you must perform the procedure in the procedure column.

Before - perform before equipment operation

During - perform during equipment operation

After - perform after equipment has been operated

Weekly - perform every week

Monthly - perform each month

Hours - perform at the noted hourly interval

Item to Check/Service. Indicates the item to be checked or serviced.

PMCS PROCEDURES – Continued

Procedure. Indicates the procedure you must perform on the item listed in Item to Check/Service column. You must perform the procedure at the time specified in the Interval column.

Not Fully Mission Capable If. Indicates faults which will prevent your equipment from performing its primary mission. If you perform procedures listed in Procedure column which show faults listed in this column, do not operate the equipment. Follow standard procedures for maintaining the equipment or reporting equipment failure.

Other Special Entries. Observe all special information and notes that appear in Table 1. When a check/service procedure is required for both weekly and before intervals, it is not necessary to perform the procedure twice if the equipment is operated during the weekly period.

COMMON CHECKS AND CLEANING

Cleaning

Observe the cleanliness of clothing articles as part of the item's serviceability. Remove loose dirt, sand, and debris from all items.

Corrosion Prevention and Control

Plastics, composites, and rubbers can degrade. Degradation is caused by thermal (heat), oxidation (oxygen), solvation (solvents), or photolytic (light, typically ultraviolet) processes. The most common exposures are excessive heat or light. Damage from these processes will appear as cracking, softening, swelling, and/or breaking. Avoid contact with all solvents.

END OF WORK PACKAGE

**OPERATOR MAINTENANCE
IMPROVED OUTER TACTICAL VEST GEN III
PREVENTIVE MAINTENANCE CHECKS AND SERVICES (PMCS)**

INITIAL SETUP**Tools and Special Tools**

Brush (WP 0020, Item 1)

References

WP 0005

WP 0007

WP 0015

Materials/parts

Soap, Mild (WP 0019, Item 2)

General

Preventive maintenance checks and services (PMCS) are performed to keep the IOTV Gen III in operating condition. The checks are used to find, correct, and report problems. The operator is to do the PMCS tasks shown in Table 1.

PMCS tasks in Table 1 are to be done before and after use of the IBA system and monthly.

Before you use the IOTV Gen III, perform PMCS.

After you have used the IOTV Gen III, perform PMCS.

PMCS PROCEDURES

Table 1. Preventive Maintenance Checks and Services.

| ITEM NO. | INTERVAL | ITEM TO BE CHECKED OR SERVICED | PROCEDURE | EQUIPMENT NOT READY/AVAILABLE IF |
|----------|----------|--------------------------------|--|--|
| 1 | Before | Base Vest Assembly | <p>Soldier Inspect Base Vest Assembly.</p> <ul style="list-style-type: none"> a. Open the vest assembly and lay it flat on a clean surface so the exterior of the vest is facing down and the interior of the vest is facing up. b. Inspect the interior fabric of the vest and collar/yoke assembly for any cuts, frays or abrasions, or any damage that may interfere with the proper function of the body armor. c. Inspect the interior fabric of the vest and collar/yoke assembly for any dirt, stains or debris. Brush off any dirt or debris with a brush or rag. d. Run hands over entire surface of body armor to ensure ballistic inserts are flat. Smooth out any folds or bunching. e. Check the security of the hook and loop fasteners that close the inside fabric of the vest and attach the ballistic inserts to the interior vest fabric. f. Run fingers or hand around collar/yoke assembly checking for creases or bunching in the ballistic fabric. Smooth out any folds or bunching. | <p>Any cuts, frays or abrasions, or any damage that may interfere with the proper function of the body armor.</p> <p>Any petroleum-based stains.</p> <p>Cannot be flattened.</p> <p>Hook and loop fastener tape does not function.</p> <p>Cannot be flattened.</p> |

PMCS PROCEDURES – CONTINUED

Table 1. Preventive Maintenance Checks and Services – Continued.

| ITEM NO. | INTERVAL | ITEM TO BE CHECKED OR SERVICED | PROCEDURE | EQUIPMENT NOT READY/AVAILABLE IF |
|---|----------|-----------------------------------|---|---|
| | Before | Base Vest Assembly - Continued | <p>g. Turn vest over so that interior fabric faces down and the exterior fabric faces up.</p> <p>h. Inspect the exterior fabric of the vest and collar/yoke assembly for any cuts, frays or abrasions or any damage that may interfere with the proper function of the body armor (Figure 1).</p> | Any cuts, frays or abrasions, or any damage that may interfere with the proper function of the body armor. |
| <p>The diagram illustrates a person's hand smoothing out the exterior fabric of a vest assembly. The vest is shown from the front, with the hand placed on the chest area to ensure the fabric is flat and free of wrinkles or damage. The vest has a complex structure with various panels and straps.</p> | | | | |
| <p>Figure 1. Smoothing Out IOTV.</p> | | | | |
| 2 | Before | Hard Armor Plates | <p>Soldier Inspect hard armor plates (Figure 2). Turn in plates if:</p> | <p>Outer cover is damaged exposing the ceramic tile material.</p> <p>Plate is cracked and you hear loose pieces rattling around when shaken.</p> <p>Creaking or squeaking of ceramic tile heard when plate twisted by hand.</p> |

PMCS PROCEDURES – CONTINUED

Table 1. Preventive Maintenance Checks and Services – Continued.

| ITEM NO. | INTERVAL | ITEM TO BE CHECKED OR SERVICED | PROCEDURE | EQUIPMENT NOT READY/AVAILABLE IF |
|----------------------------------|----------|--------------------------------|-----------|--|
| | Before | Hard Armor Plates - Continued | | <p>Composite backing is delaminating (backing material plies are separating).</p> <p>Cracking of the ceramic tile is felt or heard as you firmly pinch the outer 1/2-inch perimeter of the plate.</p> <p>Plate has been hit by a bullet or fragment.</p> |
| | | | | |
| <p>Figure 2. Inspect Plates.</p> | | | | |

PMCS PROCEDURES – CONTINUED

Table 1. Preventive Maintenance Checks and Services – Continued.

| ITEM NO. | INTERVAL | ITEM TO BE CHECKED OR SERVICED | PROCEDURE | EQUIPMENT NOT READY/AVAILABLE IF |
|----------|----------|--------------------------------|---|----------------------------------|
| 3 | Before | IOTV Gen III Vest Assembly | <p>Soldier Don the IOTV.</p> <ol style="list-style-type: none"> a. Slip the vest assembly over your head if both shoulder straps are connected or disconnect one of the shoulder straps and enter the vest from the side. b. Pull vest assembly up to ensure that the yoke/collar protects the throat. c. Pull down on the strap to the front access panel, and lift up the front panel of the front carrier to expose the side plate carrier attachment points. <p style="text-align: center;">WARNING</p> <p>For maximum protection it is important to hold the side of the front carrier along the side of the body when pulling the side plate carrier around to the front of the body. Failure to do so will result in reduced protection and could result in injury or death to the wearer.</p> <ol style="list-style-type: none"> d. Use one hand to hold the side of the front carrier under the arm to keep it smooth and snug, and with the other hand pull the side plate carrier towards the center of the front carrier. e. Tighten or loosen the webbing strap to ensure a snug fit, and then connect the buckle. Repeat for the other side. | |

PMCS PROCEDURES – CONTINUED

Table 1. Preventive Maintenance Checks and Services – Continued.

| ITEM NO. | INTERVAL | ITEM TO BE CHECKED OR SERVICED | PROCEDURE | EQUIPMENT NOT READY/AVAILABLE IF |
|----------|----------|--|--|---|
| | Before | IOTV Gen III Vest Assembly - Continued | f. Lower the front flap and tuck the end of the flap into the lower pocket. g. If installed, wrap the straps of the deltoid protectors securely around your biceps. | |
| 4. | Before | IOTV Gen III Vest Assembly | <p>Second Soldier</p> Check for proper fit of IOTV Gen III. a. Vest assembly should fit securely with no folds against the body and no movement when turning side to side. b. Bottom of hard armor plates in side plate pockets align as closely as possible to the bottom of the hard armor in the front carrier. c. Hard armor plates in the side plate pockets are positioned directly under the arm. d. There is at least a ½-inch overlap of fabric where the front and back carriers join at the shoulder. e. Lift up the lower panel on the exterior of the back carrier to expose the attachment points for the side plate carrier. f. Remove the side plate carrier from the back carrier if necessary to adjust the position of the side plate pockets in accordance with WP 0007. | Hard armor plates are not aligned with the arm. Overlap is less than ½ inch. |

PMCS PROCEDURES – CONTINUED

Table 1. Preventive Maintenance Checks and Services – Continued.

| ITEM NO. | INTERVAL | ITEM TO BE CHECKED OR SERVICED | PROCEDURE | EQUIPMENT NOT READY/AVAILABLE IF |
|----------|----------|--|--|----------------------------------|
| | Before | IOTV Gen III Vest Assembly - Continued | <p>g. Tighten or loosen the fit of the side plate carrier by releasing the webbing hanger lock and adjusting the side plate carrier inward or outward, and then re-secure the side plate carrier in accordance with WP 0007.</p> <p>h. Any additional pouches or gear should not cross front and back carriers or connect the side plate carrier. This will interfere with the emergency release. Readjust if necessary.</p> <p>i. Check both shoulders for proper overlap. Front and back carriers should overlap a minimum of ½ inch. Readjust if necessary.</p> <p>j. Check the emergency release assembly under the access panel at the top of the front carrier. The assembly should be fully seated, and the emergency release strap should lie on top of the emergency release assembly reinforcement (Figure 3).</p> | |



Figure 3. Emergency Release Assembly.

PMCS PROCEDURES – CONTINUED

Table 1. Preventive Maintenance Checks and Services – Continued.

| ITEM NO. | INTERVAL | ITEM TO BE CHECKED OR SERVICED | PROCEDURE | EQUIPMENT NOT READY/AVAILABLE IF |
|----------|-----------------|--------------------------------|--|----------------------------------|
| 5. | Before | IBA | Soldier Ensure all components are attached to IOTV per unit SOP. | |
| 6. | Before After | Emergency Release Assembly | Soldier Check for proper emergency release connections. <ol style="list-style-type: none"> a. Remove all hard armor plates. b. Don the vest assembly. c. Pull the emergency release assembly strap to ensure the vest assembly completely disengages. d. Reattach the vest assembly and ensure the cables are properly connected in accordance with WP 0015. e. Stow the emergency release strap under the access panel and secure the hook and loop. | |
| 7. | After | IBA | Soldier Doff IOTV. <ol style="list-style-type: none"> a. If attached, remove the deltoid protector attachment straps from the arms. b. Pull down on the strap to the front panel of the front carrier and lift the panel up. c. Detach both buckles of the side plate carrier. | |

PMCS PROCEDURES – CONTINUED

Table 1. Preventive Maintenance Checks and Services – Continued.

| ITEM NO. | INTERVAL | ITEM TO BE CHECKED OR SERVICED | PROCEDURE | EQUIPMENT NOT READY/AVAILABLE IF |
|----------|----------|--------------------------------|--|--|
| | After | IBA - Continued | d. Lift the vest over the head, or disconnect one of the side release buckles at the shoulder and remove the vest assembly. | |
| 8. | After | Hard Armor Plates | <p>Soldier</p> <p>a. Inspect hard armor plates. Turn in plates if:</p> <p>b. Clean your hard armor plates thoroughly before storing</p> <p>c. Place the hard armor plates into the IOTV pockets in the same manner as when worn. This prevents loss of plates.</p> <p>d. Store the IOTV system as flat as possible to avoid bunching of materials.</p> <p>e. It is recommended that the system, when dry, be stored in a plastic bag to keep out dirt, dust and moisture.</p> | <p>Outer cover is damaged exposing the ceramic tile material.</p> <p>Plate is cracked and you hear loose pieces rattling around when shaken.</p> <p>Creaking or squeaking of ceramic tile heard when plate twisted by hand.</p> <p>Composite backing is delaminating (backing material plies are separating).</p> <p>Cracking of the ceramic tile is felt or heard as you firmly pinch the outer ½-inch perimeter of the plate.</p> <p>Plate has been hit by a bullet or fragment.</p> |

PMCS PROCEDURES – CONTINUED

Table 1. Preventive Maintenance Checks and Services – Continued.

| ITEM NO. | INTERVAL | ITEM TO BE CHECKED OR SERVICED | PROCEDURE | EQUIPMENT NOT READY/AVAILABLE IF |
|----------|----------|--------------------------------|---|----------------------------------|
| 9. | Monthly | IBA | <p>Soldier Disassemble IOTV.</p> <p>a. Remove hard armor plates from the front and back carriers, if installed (Figure 4).</p> | |

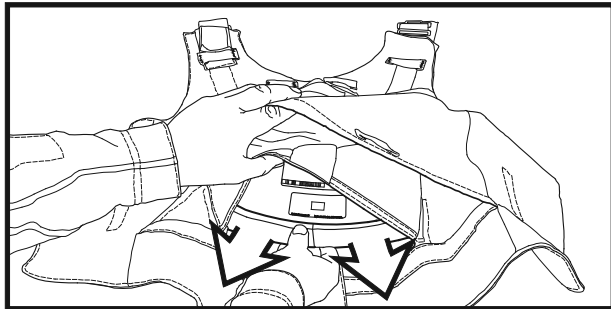

Figure 4. Removing Hard Armor Plates from Front Carrier.

- b. Remove hard armor plates from side carriers, if installed.
- c. Remove the deltoid protectors, lower back protector and groin protector, if attached, and remove ballistic inserts from each (Figure 5).



Figure 5. Removing Soft Ballistic Inserts.

PMCS PROCEDURES – CONTINUED

Table 1. Preventive Maintenance Checks and Services – Continued.

| ITEM NO. | INTERVAL | ITEM TO BE CHECKED OR SERVICED | PROCEDURE | EQUIPMENT NOT READY/AVAILABLE IF |
|----------|----------|--------------------------------|---|----------------------------------|
| | Monthly | IBA - Continued | <p>d. Remove yoke/collar from vest and remove yoke/collar ballistic inserts (Figure 6).</p>  <p>e. Separate the front and back carriers by removing the cable release completely and unsnapping and releasing the hook and loop fasteners on the left shoulder.</p> <p>f. Remove side plate carriers.</p> <p>g. Remove ballistic inserts from front and back carriers.</p> <p>h. Reassemble in accordance with WP 0005.</p> | |

Figure 6. Removing Yoke/Collar Assembly.

PMCS PROCEDURES – CONTINUED

Table 1. Preventive Maintenance Checks and Services – Continued.

| ITEM NO. | INTERVAL | ITEM TO BE CHECKED OR SERVICED | PROCEDURE | EQUIPMENT NOT READY/AVAILABLE IF |
|----------|----------|--------------------------------|---|------------------------------------|
| 10. | Monthly | IBA | <p>Soldier Inventory the body armor.</p> <p>a. Ensure all components are available per unit SOP.</p> <p>Components: Front Carrier Front Ballistic Insert Back Carrier Back Ballistic Insert Universal Side Plate Carrier (x2) Universal Side Plate Pocket (x2) Front Yoke/Collar Assembly Back Yoke/Collar Assembly Lower Back Protector Lower Back Protector Ballistic Insert Deltoid Protector (x2) Deltoid Protector Ballistic Insert (x2) Groin Protector Groin Protector Ballistic Insert Groin Protector Plastic Insert SBI Hard Armor Plate (x2) SAPI Hard Armor Plate (x2)</p> <p>b. Check the data label on each component to ensure each component is in the same size or size range in accordance with WP 0005.</p> | Item sizes are mismatched. |
| 11. | Monthly | IOTV Cloth Items | <p>Soldier Inspect each cloth item for tears, punctures or abrasions.</p> | Any tears, punctures or abrasions. |
| 12. | Monthly | Soft Ballistic Inserts | <p>Soldier Inspect soft ballistic inserts for any tear, puncture, abrasion or heavy discoloration.</p> | Any damage or heavy discoloration. |
| 13. | Monthly | IOTV | <p>Soldier Inspect each item for heavy staining. Use mild soap to clean the area.</p> | |

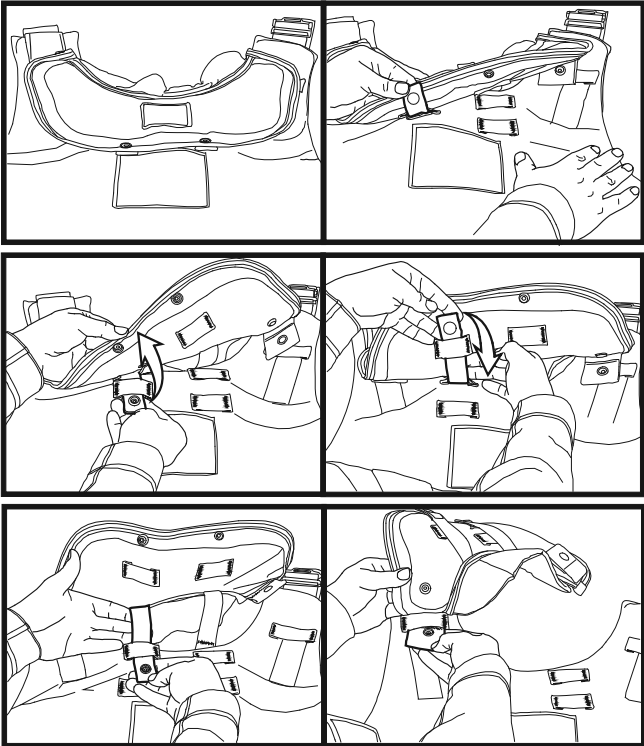
PMCS PROCEDURES – CONTINUED

Table 1. Preventive Maintenance Checks and Services – Continued.

| ITEM NO. | INTERVAL | ITEM TO BE CHECKED OR SERVICED | PROCEDURE | EQUIPMENT NOT READY/AVAILABLE IF |
|--|----------|---|--|----------------------------------|
| 14. | Monthly | Soft Ballistic Inserts | <p>Soldier Hand wash all components, except hard armor plates, soft ballistic inserts and emergency release assembly (Figure 7).</p> | |
| | | | | |
| <p>Figure 7. Cleaning Restrictions.</p> | | | | |
| <p>WARNING</p> | | | | |
| <p>Washing IOTV components in hot water will damage the fabric. Hand wash IOTV components in cold water only.</p> | | | | |
| | | <p>a. Remove dirt from outer surface using a cloth or soft bristle brush.</p> <p>b. Hand wash IOTV outer-shell and component carrier covers only in cold or warm water, with mild detergent or soap.</p> <p>c. Air dry all components away from direct heat or sun.</p> | | |

PMCS PROCEDURES – CONTINUED

Table 1. Preventive Maintenance Checks and Services – Continued.

| ITEM NO. | INTERVAL | ITEM TO BE CHECKED OR SERVICED | PROCEDURE | EQUIPMENT NOT READY/AVAILABLE IF |
|----------|----------|--------------------------------|--|----------------------------------|
| 15. | Monthly | Hard Armor Plates | <p>Soldier Clean hard armor plates.</p> <p>a. Remove loose dirt and lint from the outer surface of the hard armor plates using a cloth or soft bristle brush. Never use a stiff bristle brush.</p> <p>b. Wet the hard armor plates in a sink or shower using warm, not hot, water.</p> <p>c. Apply a mild soap or detergent to the soiled areas and scrub with a cloth or soft bristle brush. Scrub only long enough to remove soil.</p> <p>d. Heavy grease/oil stains may be pre-spotted with a detergent mixture and scrubbed with a soft brush.</p> <p>e. Rinse the hard armor plates with warm water until all suds are completely gone.</p> <p>f. Let the plate dry by itself, away from heat or open flame.</p> | |
| 16. | Monthly | Soft Ballistic Inserts | <p>Soldier Clean soft ballistic inserts and emergency release assembly with a damp cloth.</p> | |
| 17. | Monthly | IOTV | <p>Soldier Install soft ballistic inserts in carriers (front, back, lower back protector, groin protector, and deltoid protector) in accordance with WP 0005.</p> | |

PMCS PROCEDURES – CONTINUED

Table 1. Preventive Maintenance Checks and Services – Continued.

| ITEM NO. | INTERVAL | ITEM TO BE CHECKED OR SERVICED | PROCEDURE | EQUIPMENT NOT READY/AVAILABLE IF |
|----------|----------|--------------------------------|---|----------------------------------|
| | Monthly | IOTV - Continued | <p>a. Lay the carrier on a flat surface with interior, label side facing up (Figure 8).</p>  <p>b. Separate hook and loop seam and install soft ballistic insert with the label side facing up.</p> <p>c. Position insert, aligning the hook and loop tapes and ensuring the carrier material is smooth and flat after the installation.</p> <p>d. Re-seal seam of the insert pocket.</p> | Seam does not re-seal. |

Figure 8. Installing Soft Ballistic Inserts.

PMCS PROCEDURES – CONTINUED

Table 1. Preventive Maintenance Checks and Services – Continued.

| ITEM NO. | INTERVAL | ITEM TO BE CHECKED OR SERVICED | PROCEDURE | EQUIPMENT NOT READY/AVAILABLE IF |
|----------|----------|--------------------------------|---|----------------------------------|
| 18. | Monthly | Emergency Release Assembly | <p>Soldier</p> <p>Test emergency release assembly.</p> <ol style="list-style-type: none"> a. Remove all hard armor plates. b. Don the vest assembly. c. Pull the emergency release assembly strap to ensure the vest assembly completely disengages. d. Reattach the vest assembly and ensure the cables are properly connected in accordance with WP 0015. e. Stow the emergency release strap under the access panel and secure the hook and loop. | |
| 19. | Monthly | IBA | <p>Soldier</p> <p>Adjust IOTV size.</p> <ol style="list-style-type: none"> a. Don IOTV. b. Secure the side plate carriers to the front carrier by attaching the buckles. c. Lift the lower panel on the front carrier and tighten or loosen the straps on the buckles evenly. The side plate carriers should fit securely against the vest. d. If more adjustment is necessary, unbuckle the side plate carrier and remove the vest. e. Place the back carrier on a flat surface with the exterior facing up. | |

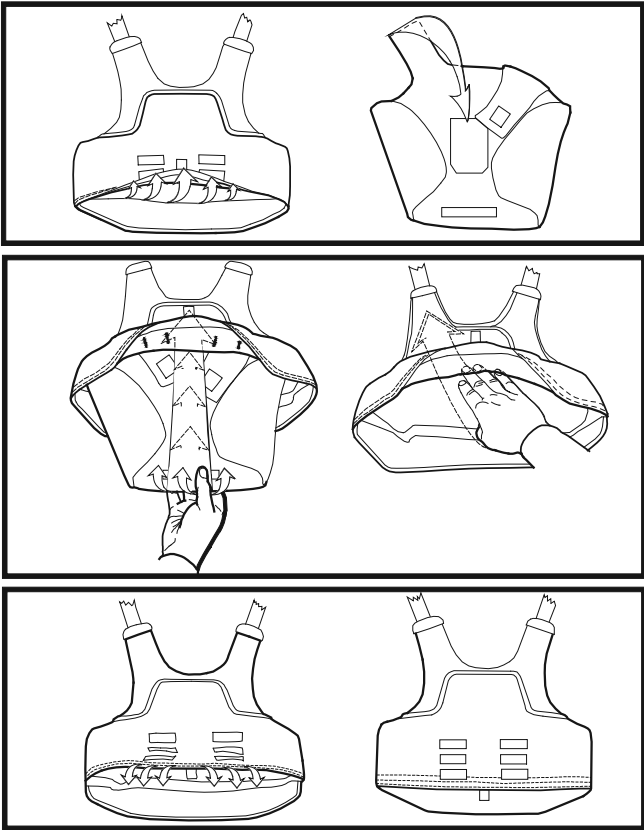
PMCS PROCEDURES – CONTINUED

Table 1. Preventive Maintenance Checks and Services – Continued.

| ITEM NO. | INTERVAL | ITEM TO BE CHECKED OR SERVICED | PROCEDURE | EQUIPMENT NOT READY/AVAILABLE IF |
|----------|----------|--------------------------------|--|----------------------------------|
| | Monthly | IBA - Continued | <p>f. Pull down on the webbing strap at the bottom of the lower back panel and lift up to gain access to the side plate carrier adjustments.</p> <p>g. The side plate carriers attach to the PALS by means of a webbing hanger. Pull outward on the webbing hanger's pull cord to unlock the webbing hanger.</p> <p>h. Slide the webbing hanger out of the webbing loops.</p> <p>i. Adjust inward (tighten) or outward (loosen) to achieve the correct fit.</p> <p>j. Rethread the webbing hanger through the webbing loops on the back and side plate carriers in accordance with WP 0005, and snap the top of the webbing hanger back against the carrier to lock it.</p> <p>k. Repeat until the vest fits firmly and comfortably on the body. Ensure all straps are adjusted evenly.</p> <p>l. Close the access panel aligning the sides of the panel with the hook and loop on the back carrier, and tuck the flap up and into the back flap pocket.</p> | |

END OF TASK

MANDATORY REPLACEMENT PARTS

There are no mandatory replacement parts for the IOTV GEN III.

END OF TASK

END OF WORK PACKAGE

CHAPTER 4

MAINTENANCE INSTRUCTIONS
FOR
IMPROVED OUTER TACTICAL VEST GEN III
(IOTV GEN III)

**OPERATOR MAINTENANCE
IMPROVED OUTER TACTICAL VEST GEN III
PREPARATION FOR STORAGE OR SHIPMENT**

General Storage Requirements

Administrative storage will be in accordance with the following:

1. Clean all items and ensure they are dry before IBA is placed in storage. Store each individual IBA in a plastic bag to keep out dirt, dust and moisture. Placement of clothing items in administrative storage should be for short periods of time. Ensure all items are protected from pilferage, dampness, fire, dirt, and rodents.
2. Insert the SAPI/SBI into the IBA pockets in the same manner as when worn. This prevents loss of components. Store the IBA system as flat as possible to avoid bunching of materials.
3. Items should be in mission readiness within 24 hours or within the time factors as determined by the directing authority.
4. During the storage period, appropriate maintenance records will be kept. Before placing equipment in administrative storage, current maintenance services and equipment serviceable criteria evaluations should be completed, shortcomings and deficiencies should be corrected, and all modification work orders should be applied.
5. Inside storage is preferred for items selected for administrative storage. If inside storage is not available, trucks, vans, CONEX containers and other containers may be used.

In-Storage Inspection

1. Check that no damage or deterioration has occurred.
2. Check the adequacy of the storage facilities, efforts taken to control pests and rodents, and protection against unfavorable climatic conditions and other elements that might cause damage to clothing items.

Shipment Requirements

Ensure all items are protected from pilferage, dampness, fire, dirt, and rodents.

END OF WORK PACKAGE

**OPERATOR MAINTENANCE
IMPROVED OUTER TACTICAL VEST GEN III
CLEANING**

INITIAL SETUP**Tools and Special Tools**

Brush (WP 0020, Item 1)

Materials/parts

Soap, Mild (WP 0019, Item 2)

GENERAL CLEANING INSTRUCTIONS**WARNING**

Failure to follow all cleaning instructions could deteriorate, damage, or destroy the IBA, rendering it useless against ballistic threats.

To maintain your IBA so that it provides you with the maximum protection intended, it is extremely important to follow proper cleaning procedures. Do not bleach, machine wash, dry clean, or apply solvents, cleaning fluids, or yellow soap to any part of the IBA. They will discolor and/or deteriorate the IBA. Do not attempt to dye item or fix discolorations.

IBA Vest Assembly and Components**WARNING**

Do not machine wash or dry. Failure to follow these instructions may render your IBA useless against ballistic threats.

CAUTION

Do not use a stiff brush to clean any part of your IBA as this will damage the material.

1. Remove loose dirt and lint from the outer shell using a cloth or soft bristle brush. Never use a stiff bristle brush.
2. Remove all soft ballistic inserts and the hard armor plates from the outer shell and component carriers.

GENERAL CLEANING INSTRUCTIONS – CONTINUED**IBA Vest Assembly and Components - Continued****CAUTION**

Never use bleach, yellow soap, cleaning fluids or solvents to clean the outer shell as this will stain and damage the material.

3. Hand-wash the outer shell and component carrier covers in cold or warm water, with mild detergent or soap.
4. Badly soiled areas may be scrubbed. Scrub only long enough to remove soil.
5. Grease and oil stains may be pre-spotted with a mild detergent and water mixture, and scrubbed with a soft brush. If stubborn stain persists, repeat the procedure.
6. Rinse the outer shell and covers thoroughly in clean, warm water until suds are completely gone.
7. Air-dry indoors or in shade, away from heat sources and direct sunlight.

END OF TASK**Soft Ballistic Inserts****WARNING**

Do not machine wash or dry the soft ballistic inserts. Failure to follow these instructions may render the IBA useless against ballistic threats.

CAUTION

Do not intentionally submerge soft inserts in any liquid, including water. Do not use a stiff brush to clean any part of your IBA as this will damage the material.

Cleaning of the soft ballistics inserts is limited to removing loose dirt from the surface with a cloth or soft brush. If ballistic inserts become wet, allow to air dry in a flat position away from heat sources and direct sunlight. If ballistic insert becomes saturated with liquids such as gasoline, bleach or other lubricants, turn in for replacement as soon as possible.

END OF TASK

GENERAL CLEANING INSTRUCTIONS – CONTINUED**Hard Armor Plates****WARNING**

Do not machine wash or dry the SAPI/SBI inserts. Failure to follow these instructions may degrade the SAPI/SBI ballistic protection.

CAUTION

Do not submerge SAPI/SBI inserts in any liquid, including water.

Do not use a stiff brush to clean any part of your IBA as this will damage the material.

1. Remove loose dirt and lint from the outer surface of the SAPI/SBI using a cloth or soft bristle brush. Never use a stiff bristle brush.
2. Wet the SAPI/SBI in a sink or shower using warm, not hot, water.
3. Apply a mild soap or detergent to the soiled areas and scrub with a cloth or soft bristle brush.
4. Badly soiled areas may be scrubbed with mild soap or detergent.
5. Scrub only long enough to remove soil.
6. Rinse the SAPI/SBI with warm water until all suds are completely gone.
7. Let the insert dry by itself, away from heat or open flame.

END OF TASK**END OF WORK PACKAGE**

OPERATOR MAINTENANCE
IMPROVED OUTER TACTICAL VEST GEN III
FABRIC REPAIR

INITIAL SETUP**Materials/parts**

Kit, Sewing (WP 0019, Item 1)

Tape, Pressure Sensitive Adhesive (WP
0019, Item 3)

REPAIR**WARNING**

Fabric repair in this work package does not apply to the fabric on the soft ballistic inserts. Any damage to the soft ballistic inserts is cause for turn-in. Failure to follow these instructions could result in degraded ballistic protection.

This work package provides instructions for repairing the fabric of the IBA.

Outer Shell

1. To mend a ripped seam, overlap the two-edges and sew with straight and small stitches (Figure 1).



Figure 1. Straight Stitch.

2. To repair a tear, place the two edges together on the inside, and sew together (Figure 2).



Figure 2. Edge Sew.

REPAIR – CONTINUED

3. To mend a frayed edge, turn the frayed edge under and sew (Figure 3).



Figure 3. Turn Edge Under and Sew.

NOTE

Cloth backed adhesive tape is often referred to as duct tape, rigger's tape or 100 mile-per-hour tape.

4. Interim repairs can be made with cloth backed adhesive tape to prevent tears or holes in the carrier from expanding until the vest can be exchanged. The tape can be used to keep the vest closed, hold the ballistic panels in place, or repair any hook and pile that has been damaged.

END OF TASK

END OF WORK PACKAGE

OPERATOR MAINTENANCE
IMPROVED OUTER TACTICAL VEST GEN III
HARD ARMOR – INSPECT, REPAIR

INITIAL SETUP**Materials/parts:**

Tape, Pressure Sensitive Adhesive (WP
0019, Item 3)

INSPECT**WARNING**

Soldiers must ensure they have the correct protective inserts. The ESAPI and ESBI have green covers and the XSAPI and XSBI have tan covers. All of these inserts provide a higher level of protection than the Small Arms Protective Insert (SAPI) and the Side Ballistic Inserts (SBI) which have black covers.

ESAPI should be worn by all personnel in theater. If a service member has the older black SAPI plates, they should be turned in and replaced with green ESAPI plates. Failure to ensure the correct plate while conducting combat operations may result in injury or death.

Pre-combat Inspection

The Soldier must inspect the insert before each mission. The SAPI/SBI insert must be turned in if any of the following conditions are present:

- Outer cover is damaged exposing the ceramic tile material.
- Plate is cracked and you hear loose pieces rattling around when shaken.
- Creaking or squeaking of ceramic tile heard when plate twisted by hand.
- Composite backing is delaminating (backing material plies are separating).
- Cracking of the ceramic tile is felt or heard as you firmly pinch the outer ½-inch perimeter of the plate.
- Plate has been hit by a bullet or fragment.

END OF TASK

REPAIR**NOTE**

Cloth backed adhesive tape is often referred to as duct tape, rigger's tape or 100 mile-per-hour tape.

Interim repairs of the SAPI/SBI outer cover can be made using cloth backed adhesive tape until it can be exchanged. This repair does help to prevent the spread of existing delamination. It is not meant as a permanent fix.

END OF TASK**END OF WORK PACKAGE**

OPERATOR MAINTENANCE
IMPROVED OUTER TACTICAL VEST GEN III
HARDWARE AND EMERGENCY RELEASE ASSEMBLY – INSPECT, REPAIR

INITIAL SETUP:**Tools and Special Tools**

Multi-tool (WP 0020, Item 2)

References

WP 0007

Materials/Parts

None Required

INSPECT**Pre-combat Inspection**

The Soldier must inspect the acetyl hardware (male and female buckle ends, webbing hangers, and D-rings) and emergency release assembly before each mission.

END OF TASK**REPAIR****Replace the Male Buckle End**

There are four male buckle ends on the front carrier—one on each shoulder and two at the attachment points for the side plate carrier.

CAUTION

Do not damage the webbing when breaking or removing the buckle ends. If the webbing is cut or damaged such that the buckle cannot be securely attached, turn the equipment in for replacement.

1. Break the damaged buckle end at the webbing.
2. Remove the screw from the catch lever.
3. Raise the catch lever on the buckle (Figure 1).

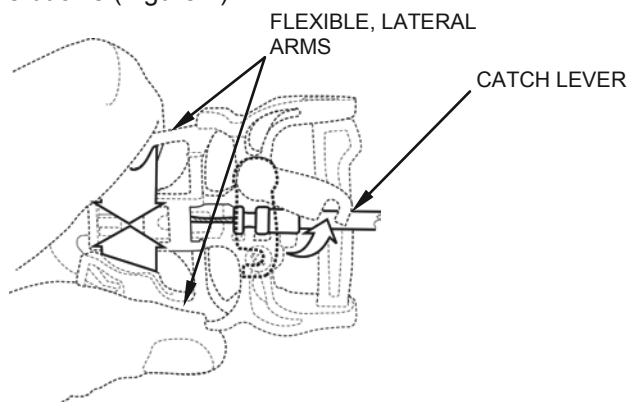

Figure 1. Catch Lever on Buckle.

REPAIR – CONTINUED**Replace the Male Buckle End – Continued**

4. Squeeze the two flexible, lateral arms and lift the cable out of the housing on the neck in which it is seated.
5. Remove the damaged buckle from the webbing completely.
6. With the catch lever facing toward the exterior fabric, slide the replacement male buckle end into the webbing and snap it in place.
7. Raise the catch lever of the replacement buckle, and squeeze the flexible, lateral arms of the buckle.
8. Push the cable nut down at an angle and into the tray that slides out when the lateral arms are squeezed.
9. Ensure that the groove between the round, black-coated end of the cable and the remaining cable sleeve is firmly seated in housing.

WARNING

The cable must be seated correctly for the emergency release assembly to function properly. Failure to do so will affect performance of the emergency release and may cause injury or death to personnel.

10. Press the cable firmly into the channel until it snaps in place (Figure 2).

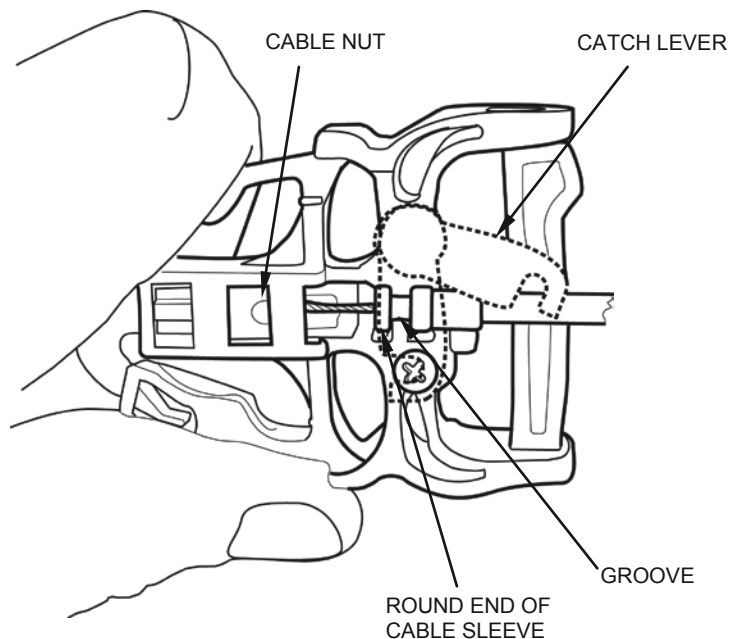

Figure 2. Cable in Buckle.

REPAIR – CONTINUED**Replace the Male Buckle End – Continued**

11. Push the catch lever over the cable to secure it.

WARNING

When the catch lever is closed, the edge of the round, black cable sleeve closest to the cable nut must be visible. If the cable is not placed correctly, remove the cable from the channel and reinsert it. Failure to do so will affect performance of the emergency release and may cause injury or death to personnel.

12. Complete a visual check to ensure that the cable is in the secure and correct position (Figure 3) when the lever is closed and not partially secure (Figure 4).

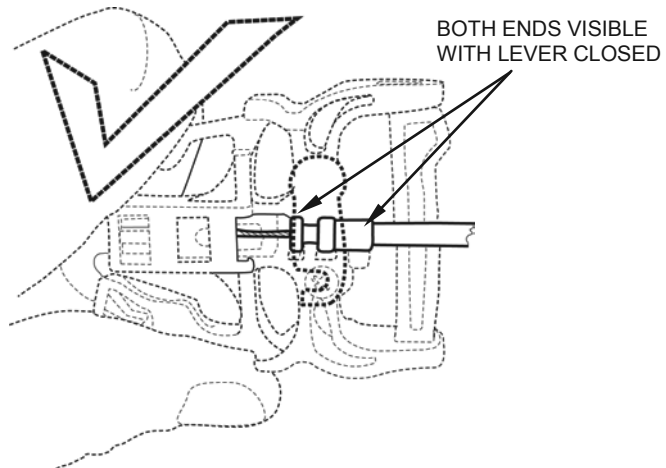

Figure 3. Correct and Secure Placement of the Cable.

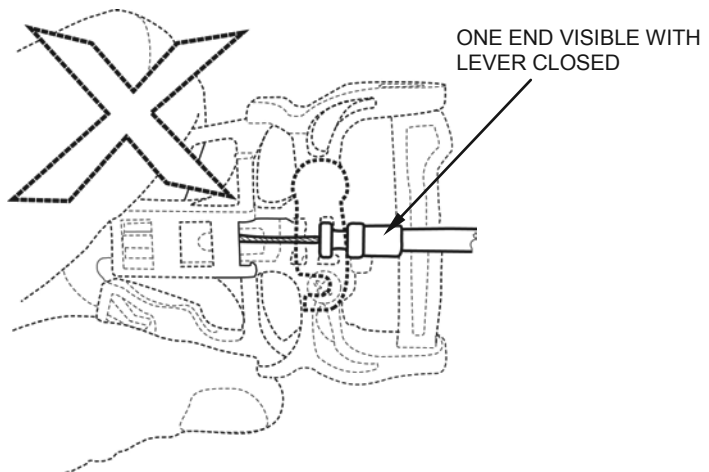

Figure 4. Incorrect Placement of the Cable.

REPAIR – CONTINUED

Replace the Male Buckle End – Continued

13. Insert the catch lever screw and tighten.
14. Don the vest assembly without the hard armor plates.
15. Pull the emergency release assembly strap to test the emergency release assembly.

Replace the Adjustable Female Buckle End

There are two adjustable, double-bar female buckles—one on each side plate carrier (Figure 5).



Figure 5. Adjustable Buckle on Side Plate Carrier.

1. Unthread the webbing from the damaged buckle end on the side plate carrier.
2. Thread the webbing back through the replacement buckle end.
3. Adjust in accordance with WP 0007.

Replace the Emergency Release Assembly

WARNING

If damage to any component of the emergency release assembly occurs, replace the complete assembly. Failure to do so will affect performance of the emergency release and may cause injury or death to personnel.

1. Remove the emergency release assembly cables from the buckles at each shoulder and the buckles at the side plate carrier attachment points on the front carrier.
2. Remove the screw from the catch lever.

REPAIR – CONTINUED**Replace the Emergency Release Assembly – Continued**

3. Raise the catch lever of the buckle (Figure 6).

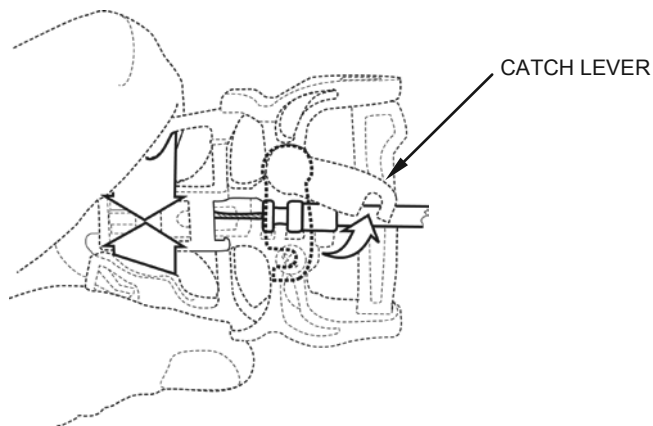

Figure 6. Catch Lever on Buckle.

4. Squeeze the two flexible, lateral arms, lift the cable out of the housing on the neck in which it is seated, and remove the cable from the buckle.
5. Raise the top flap on the front carrier securing the emergency release assembly.
6. Lift up the emergency release buckle reinforcement.
7. Pull the emergency release assembly strap and completely remove the cable plate and the four cables from the front carrier (Figure 7).

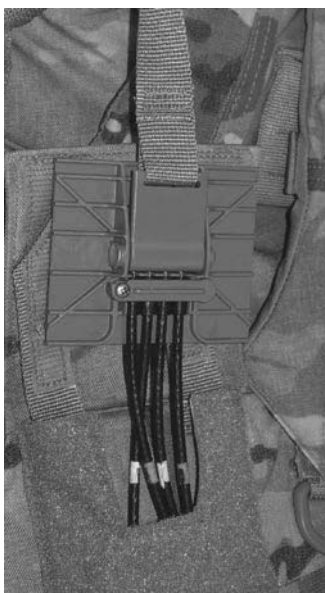

Figure 7. Emergency Release Assembly.

REPAIR – CONTINUED**Replace the Emergency Release Assembly – Continued**

8. Route the cables of the replacement emergency release assembly to the buckle attachment points.
 - a. Open the back of the front carrier.
 - b. Pass the cables under the access panel at the top of the front carrier.
 - c. Route the two outer cables with magenta markings to the buckle ends on the shoulders.
 - d. Route the two inner cables with white markings to the buckle ends at the side plate carrier attachment points.

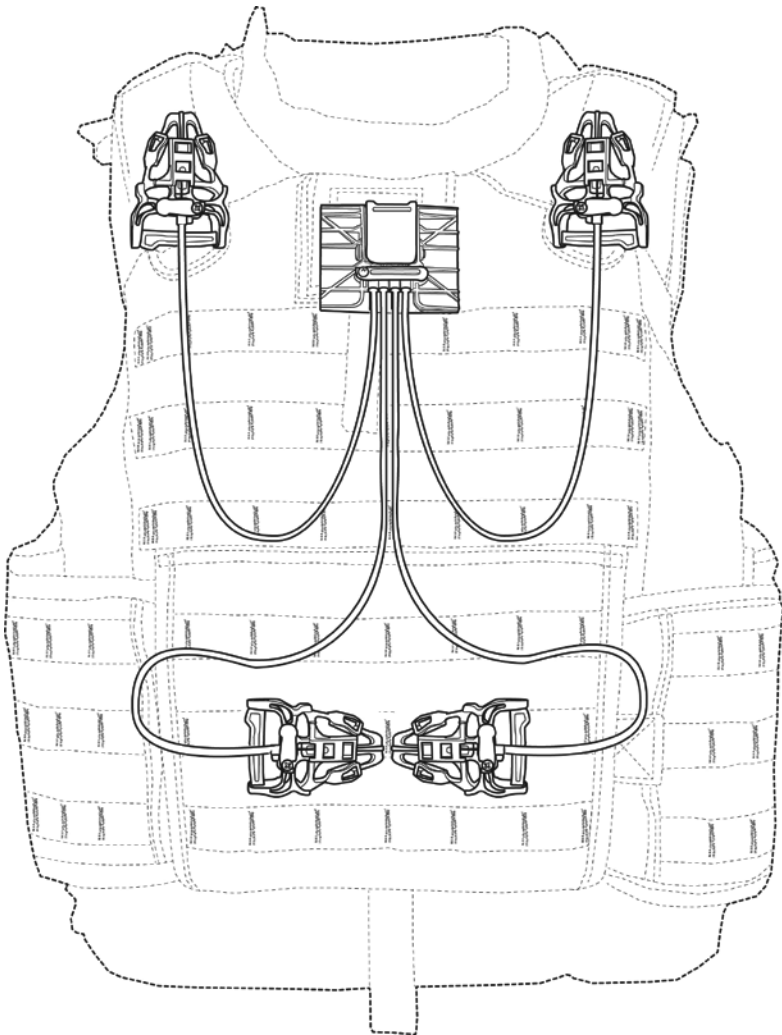

Figure 8. Cable Connection Points.

REPAIR – CONTINUED**Replace the Emergency Release Assembly – Continued**

- e. Slide the cable plate into position under the access panel.
- f. Lower the emergency release buckle reinforcement ensuring that the emergency release strap is lying freely on top of the reinforcement (Figure 9).

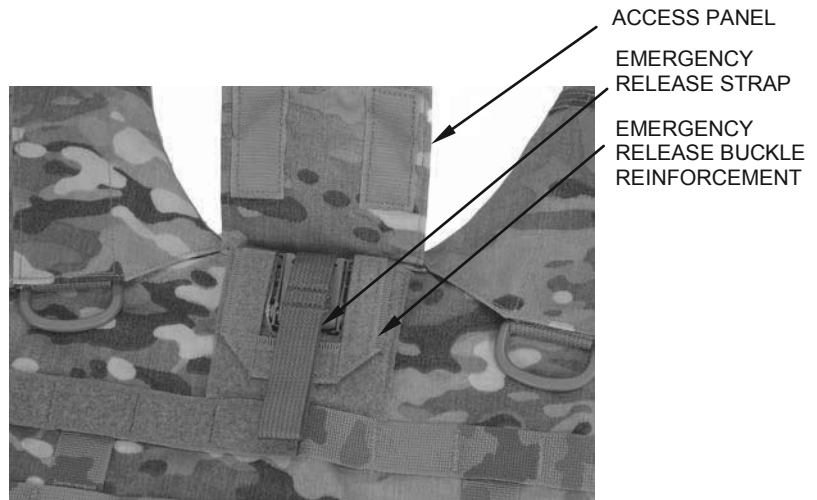

Figure 9. Emergency Release Assembly Strap and Buckle Reinforcement.

- g. Seal the hook and loop of the emergency release buckle reinforcement, and close the access panel.
9. Attach the cables to the four buckle ends on the front carrier (Figure 8).
- a. Raise the catch lever of the replacement male buckle, and squeeze the lateral arms of the buckle.
 - b. Push the cable nut down at an angle and into the tray that slides out when the lateral arms are squeezed.
 - c. Ensure that the groove between the round, black-coated end of the cable and the remaining covered cable is firmly seated in housing.
10. Check for proper emergency release connections.
- a. Remove all hard armor plates if installed.
 - b. Don the vest assembly.
 - c. Pull the emergency release assembly strap to ensure the vest assembly completely disengages.
 - d. Reattach the vest assembly in accordance with WP 0005.

END OF TASK

END OF WORK PACKAGE

CHAPTER 5

SUPPORTING INFORMATION
FOR
IMPROVED OUTER TACTICAL VEST GEN III
(IOTV GEN III)

**OPERATOR MAINTENANCE
IMPROVED OUTER TACTICAL VEST GEN III
REFERENCES**

SCOPE

This work package lists related field manuals, forms, technical manuals, and miscellaneous publications.

ARMY REGULATION

AR 700-138 Army Logistics Readiness and Sustainability

COMMON TABLES

CTA 8-100 Army Medical Department Expendable/Durable Items
CTA 50-909 Field and Garrison Furnishings and Equipment
CTA 50-970 Expendable/Durable Items (Except Medical, Class V
Repair Parts, and Heraldic Items)

FIELD MANUALS

FM 3-11.3 Multiservice Tactics, Techniques, and Procedures for
Chemical, Biological, and Nuclear Contamination
Avoidance
FM 4-25.11 First Aid

FORMS

DA Form 12-R Request for Establishment of a Publications Account
DA Form 2028 Recommended Changes to Publications and Blank
Forms
DA Form 2404 Equipment Inspection and Maintenance Worksheet
SF 368 Product Quality Deficiency Report

PAMPHLETS

DA PAM 25-33 User's Guide for Army Publications and Forms
DA PAM 738-751 Functional Users Manual for the Army Maintenance
Management System – (TAMMS-A)
DA PAM 750-8 The Army Maintenance Management System (TAMMS)
Users Manual

TECHNICAL MANUALS

TM 750-244-1-2 Procedures for the Destruction of Life Support
Equipment to Prevent Enemy Use

END OF WORK PACKAGE

OPERATOR MAINTENANCE
IMPROVED OUTER TACTICAL VEST GEN III
COMPONENTS OF END ITEM (COEI) AND BASIC ISSUE ITEMS (BII) LISTS

INTRODUCTION

Scope

This work package lists COEI and BII for the Improved Outer Tactical Vest Gen III (IOTV Gen III) to help you inventory items for safe and efficient operation of the equipment.

General

The COEI and BII information is divided into the following lists:

Components of End Item (COEI). This list is for information purposes only and is not authority to requisition replacements. These items are part of the IBA. As part of the end item, these items must be with the end item whenever it is issued or transferred between property accounts. Items of COEI are removed and separately packaged for transportation or shipment only when necessary. Illustrations are furnished to help you find and identify the items.

Basic Issue Items (BII). These essential items are required to place the IBA in operation, operate it and to do emergency repairs. Although shipped separately packaged, BII must be with the IBA during operation and when it is transferred between property accounts. Listing these items is your authority to request/requisition them for replacement based on authorization of the end item by the TOE/MTOE. Illustrations are furnished to help you find and identify the items.

Explanation of Columns in the COEI and BII List

Column (1) Illus Number. Gives you the reference number of the item listed.

Column (2) National Stock Number (NSN) and illustration. Identifies the stock number of the item to be used for requisitioning purposes and provides an illustration of the item.

Column (3) Description, Part Number/(CAGEC). Identifies the Federal item name (in all capital letters) followed by a minimum description when needed. The stowage location of COEI and BII is also included in this column. The last line below the description is the part number and the Commercial and Government Entity Code (CAGEC) (in parentheses).



Column (4) Usable On Code. When applicable, gives you a code if the item you need is not the same for different models of equipment.

INTRODUCTION – CONTINUED**Explanation of Columns in the COEI and BII List – Continued**

Column (5) U/I. Unit of Issue (U/I) indicates the physical measurement or count of the item as issued per the National Stock Number shown in column (2).

Column (6) Qty Rqr. Indicates the quantity required.

COMPONENTS OF END ITEM LIST**Table 1. Components of End Item (COEI) List.**

| (1) Item No. | (2) National Stock Number (NSN) and Illustration | (3) Description, Part Number/(CAGEC) | (4) Usable On Code | (5) U/I | (6) Qty Rqr |
|-----------------|---|--|-----------------------|------------|----------------|
| 1 | 8470-01-604-6876  | CARRIER, SIDE PLATE (UNIVERSAL) (XS-S), FQ-PD 07-05/(81337) | | EA | 2 |
| | 8470-01-604-6879 | CARRIER, SIDE PLATE (UNIVERSAL) (M-L), FQ-PD 07-05/(81337) | | EA | 2 |
| | 8470-01-604-6682 | CARRIER, SIDE PLATE (UNIVERSAL) (XL-2XL), FQ-PD 07-05/(81337) | | EA | 2 |
| | 8470-01-604-6883 | CARRIER, SIDE PLATE (UNIVERSAL) (3XL-4XL), FQ-PD 07-05/(81337) | | EA | 2 |
| 2 | 8470-01-604-6740  | CARRIER, VEST (BACK) (XS), FQ-PD 07-05/(81337) | | EA | 1 |
| | 8470-01-604-6741 | CARRIER, VEST (BACK) (S), FQ-PD 07-05/(81337) | | EA | 1 |
| | 8470-01-604-6742 | CARRIER, VEST (BACK) (M), FQ-PD 07-05/(81337) | | EA | 1 |
| | 8470-01-604-6743 | CARRIER, VEST (BACK) (ML), FQ-PD 07-05/(81337) | | EA | 1 |
| | 8470-01-604-6744 | CARRIER, VEST (BACK) (L), FQ-PD 07-05/(81337) | | EA | 1 |

COMPONENTS OF END ITEM LIST – CONTINUED

Table 1. Components of End Item (COEI) List – Continued.

| (1) Item No. | (2) National Stock Number (NSN) and Illustration | (3) Description, Part Number/(CAGEC) | (4) Usable On Code | (5) U/I | (6) Qty Rqr |
|-----------------|--|--|-----------------------|------------|----------------|
| | 8470-01-604-6745 | CARRIER, VEST (BACK) (LL), FQ-PD 07-05/(81337) | | EA | 1 |
| | 8470-01-604-6746 | CARRIER, VEST (BACK) (XL), FQ-PD 07-05/(81337) | | EA | 1 |
| | 8470-01-604-6747 | CARRIER, VEST (BACK) (XLL), FQ-PD 07-05/(81337) | | EA | 1 |
| | 8470-01-604-6749 | CARRIER, VEST (BACK) (2XL), FQ-PD 07-05/(81337) | | EA | 1 |
| | 8470-01-604-6751 | CARRIER, VEST (BACK) (3XL), FQ-PD 07-05/(81337) | | EA | 1 |
| | 8470-01-604-6752 | CARRIER, VEST (BACK) (4XL), FQ-PD 07-05/(81337) | | EA | 1 |
| 3 | 8470-01-604-6653  | CARRIER, VEST (FRONT) (XS), FQ-PD 07-05/(81337) | | EA | 1 |
| | 8470-01-604-6659 | CARRIER, VEST (FRONT) (S), FQ-PD 07-05/(81337) | | EA | 1 |
| | 8470-01-604-6660 | CARRIER, VEST (FRONT) (M), FQ-PD 07-05/(81337) | | EA | 1 |
| | 8470-01-604-6661 | CARRIER, VEST (FRONT) (ML), FQ-PD 07-05/(81337) | | EA | 1 |
| | 8470-01-604-6662 | CARRIER, VEST (FRONT) (L), FQ-PD 07-05/(81337) | | EA | 1 |
| | 8470-01-604-6664 | CARRIER, VEST (FRONT) (LL), FQ-PD 07-05/(81337) | | EA | 1 |
| | 8470-01-604-6667 | CARRIER, VEST (FRONT) (XL), FQ-PD 07-05/(81337) | | EA | 1 |
| | 8470-01-604-6669 | CARRIER, VEST (FRONT) (XLL), FQ-PD 07-05/(81337) | | EA | 1 |
| | 8470-01-604-6670 | CARRIER, VEST (FRONT) (2XL), FQ-PD 07-05/(81337) | | EA | 1 |
| | 8470-01-604-6771 | CARRIER, VEST (FRONT) (3XL), FQ-PD 07-05/(81337) | | EA | 1 |



COMPONENTS OF END ITEM LIST – CONTINUED

Table 1. Components of End Item (COEI) List – Continued.

| (1) Item No. | (2) National Stock Number (NSN) and Illustration | (3) Description, Part Number/(CAGEC) | (4) Usable On Code | (5) U/I | (6) Qty Rqr |
|-----------------|---|--|-----------------------|------------|----------------|
| | 8470-01-604-6772 | CARRIER, VEST (FRONT) (4XL), FQ-PD 07-05/(81337) | | EA | 1 |
| 4 | 8470-01-551-8057  | INSERT, BALLISTIC (BACK) (XS), 1503-XS/(3T951) | | EA | 1 |
| | 8470-01-551-8058 | INSERT, BALLISTIC (BACK) (S), 1503-S/(3T951) | | EA | 1 |
| | 8470-01-551-8062 | INSERT, BALLISTIC (BACK) (M), 1503-M/(3T951) | | EA | 1 |
| | 8470-01-551-8063 | INSERT, BALLISTIC (BACK) (ML), 1503-ML/(3T951) | | EA | 1 |
| | 8470-01-551-8064 | INSERT, BALLISTIC (BACK) (L), 1503-L/(3T951) | | EA | 1 |
| | 8470-01-551-8074 | INSERT, BALLISTIC (BACK) (LL), 1503-LL/(3T951) | | EA | 1 |
| | 8470-01-551-8075 | INSERT, BALLISTIC (BACK) (XL), 1503-XL/(3T951) | | EA | 1 |
| | 8470-01-551-8079 | INSERT, BALLISTIC (BACK) (XLL), 1503-XLL/(3T951) | | EA | 1 |
| | 8470-01-551-8078 | INSERT, BALLISTIC (BACK) (2XL), 1503-2XL/(3T951) | | EA | 1 |
| | 8470-01-551-8086 | INSERT, BALLISTIC (BACK) (3XL), 1503-3XL/(3T951) | | EA | 1 |
| | 8470-01-551-8087 | INSERT, BALLISTIC (BACK) (4XL), 1503-4XL/(3T951) | | EA | 1 |
| 5 | 8470-01-551-8039  | INSERT, BALLISTIC (FRONT) (XS), 1502-XS/(3T951) | | EA | 1 |
| | 8470-01-551-8040 | INSERT, BALLISTIC (FRONT) (S), 1502-S/(3T951) | | EA | 1 |

COMPONENTS OF END ITEM LIST – CONTINUED

Table 1. Components Of End Item (COEI) List – Continued.

| (1) Item No. | (2) National Stock Number (NSN) and Illustration | (3) Description, Part Number/(CAGEC) | (4) Usable On Code | (5) U/I | (6) Qty Rqr |
|-----------------|---|---|-----------------------|------------|----------------|
| | 8470-01-551-8042 | INSERT, BALLISTIC (FRONT) (M), 1502-M/(3T951) | | EA | 1 |
| | 8470-01-551-8044 | INSERT, BALLISTIC (FRONT) (ML), 1502-ML/(3T951) | | EA | 1 |
| | 8470-01-551-8045 | INSERT, BALLISTIC (FRONT) (L), 1502-L/(3T951) | | EA | 1 |
| | 8470-01-551-8047 | INSERT, BALLISTIC (FRONT) (LL), 1502-LL/(3T951) | | EA | 1 |
| | 8470-01-551-8050 | INSERT, BALLISTIC (FRONT) (XL), 1502-XL/(3T951) | | EA | 1 |
| | 8470-01-551-8051 | INSERT, BALLISTIC (FRONT) (XLL), 1502-XLL/(3T951) | | EA | 1 |
| | 8470-01-551-8053 | INSERT, BALLISTIC (FRONT) (2XL), 1502-2XL/(3T951) | | EA | 1 |
| | 8470-01-551-8054 | INSERT, BALLISTIC (FRONT) (3XL), 1502-3XL/(3T951) | | EA | 1 |
| | 8470-01-551-8055 | INSERT, BALLISTIC (FRONT) (4XL), 1502-4XL/(3T951) | | EA | 1 |
| 6 | 8470-01-584-0716  | POUCH, SIDE PLATE (UNIVERSAL) (ONE SIZE), FQ-PD 07-05/(81337) | | EA | 2 |
| 7 | 8470-01-586-2358  | YOKE AND COLLAR ASSEMBLY, BACK, IOTV OCP (XS) | | EA | 1 |
| | 8470-01-586-2438 | YOKE AND COLLAR ASSEMBLY, BACK, IOTV OCP (S) | | EA | 1 |
| | 8470-01-586-2449 | YOKE AND COLLAR ASSEMBLY, BACK, IOTV OCP (M) | | EA | 1 |
| | | | | | |



COMPONENTS OF END ITEM LIST – CONTINUED

Table 1. Components Of End Item (COEI) List – Continued.

| (1) Item No. | (2) National Stock Number (NSN) and Illustration | (3) Description, Part Number/(CAGEC) | (4) Usable On Code | (5) U/I | (6) Qty Rqr |
|-----------------|---|--|-----------------------|------------|----------------|
| | 8470-01-586-2458 | YOKE AND COLLAR ASSEMBLY, BACK, IOTV OCP (L) | | EA | 1 |
| | 8470-01-586-2536 | YOKE AND COLLAR ASSEMBLY, BACK, IOTV OCP (XL) | | EA | 1 |
| | 8470-01-586-2539 | YOKE AND COLLAR ASSEMBLY, BACK, IOTV OCP (2 XL) | | EA | 1 |
| | 8470-01-586-2540 | YOKE AND COLLAR ASSEMBLY, BACK, IOTV OCP (3 XL) | | EA | 1 |
| | 8470-01-586-2553 | YOKE AND COLLAR ASSEMBLY, BACK, IOTV OCP (4 XL) | | EA | 1 |
| 8 | 8470-01-584-0742  | YOKE AND COLLAR ASSEMBLY, FRONT, IOTV OCP (XS) | | EA | 1 |
| | 8470-01-584-0743 | YOKE AND COLLAR ASSEMBLY, FRONT, IOTV OCP (S) | | EA | 1 |
| | 8470-01-584-0745 | YOKE AND COLLAR ASSEMBLY, FRONT, IOTV OCP (M) | | EA | 1 |
| | 8470-01-584-0746 | YOKE AND COLLAR ASSEMBLY, FRONT, IOTV OCP (L) | | EA | 1 |
| | 8470-01-584-0747 | YOKE AND COLLAR ASSEMBLY, FRONT, IOTV OCP (XL) | | EA | 1 |
| | 8470-01-584-0748 | YOKE AND COLLAR ASSEMBLY, FRONT, IOTV OCP (2 XL) | | EA | 1 |
| | 8470-01-584-0749 | YOKE AND COLLAR ASSEMBLY, FRONT, IOTV OCP (3 XL) | | EA | 1 |
| | 8470-01-584-0750 | YOKE AND COLLAR ASSEMBLY, FRONT, IOTV OCP (4 XL) | | EA | 1 |

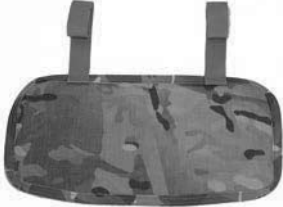

BASIC ISSUE ITEMS LIST

Table 2. Basic Issue Items (BI) List

| (1) Item No. | (2) National Stock Number (NSN) and Illustration | (3) Description, CAGEC, and Part Number | (4) Usable On Code | (5) U/I | (6) Qty Rqr |
|-----------------|---|--|-----------------------|------------|----------------|
| 1 | 8470-01-584-0788  | CARRIER, BACK PROTECTOR (JI LOWER BACK PROTECTOR CARRIER), (ONE SIZE), FQ-PD 07-05/(81337) | | EA | 1 |
| 2 | 8470-01-556-2192  | DELTOID PROTECTOR, BALLISTIC PANEL, (XS-S), CO/PD 07-10/(81337) | | EA | 2 |
| | 8470-01-556-2187 | DELTOID PROTECTOR, BALLISTIC PANEL, (M-L), CO/PD 07-10/(81337) | | EA | 2 |
| | 8470-01-520-7349 | DELTOID PROTECTOR, BALLISTIC PANEL, (XL-4XL), CO/PD 07-10/(81337) | | EA | 2 |
| 3 | 8470-01-584-0909  | DELTOID PROTECTOR OUTERSHELL, (XS-S), CO/PD 07-05/(81337) | | EA | 2 |
| | 8470-01-584-0912 | DELTOID PROTECTOR OUTERSHELL, (M-L), CO/PD 07-05/(81337) | | EA | 2 |
| | 8470-01-584-0911 | DELTOID PROTECTOR OUTERSHELL, (XL-4XL), CO/PD 07-05/(81337) | | EA | 2 |

BASIC ISSUE ITEMS LIST – CONTINUED

Table 2. Basic Issue Items (BI) List – Continued.

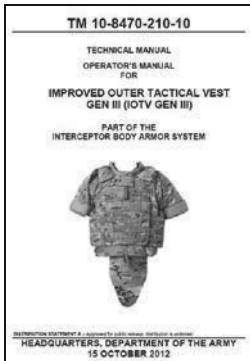
| (1) Item No. | (2) National Stock Number (NSN) and Illustration | (3) Description, CAGEC, and Part Number | (4) Usable On Code | (5) U/I | (6) Qty Rqr |
|-----------------|---|--|-----------------------|------------|----------------|
| 4 | 8470-01-604-7161  | GROIN PROTECTOR, CARRIER (XS-ML), FQ-PD 07-05/(81337) | | EA | 1 |
| | 8470-01-604-6919 | GROIN PROTECTOR, CARRIER (L-4XL), FQ-PD 07-05/(81337) | | EA | 1 |
| 5 | 8470-01-604-7155  | INSERT, BALLISTIC GROIN PROTECTOR, (XS-ML), PD-00-02/(81337) | | EA | 1 |
| | 8470-01-604-7156 | INSERT, BALLISTIC GROIN PROTECTOR, (L-4XL), PD-00-02/(81337) | | EA | 1 |
| 6 | 8470-01-551-8523  | INSERT, KIDNEY PROTECTOR (LOWER BACK PROTECTOR BALLISTIC INSERT) (ONE SIZE), 1517/(3T951) | | EA | 1 |
| 7 |  | OPERATOR MANUAL FOR IMPROVED OUTER TACTICAL VEST GEN III (IOTV GEN III) PART OF THE INTERCEPTOR BODY ARMOR SYSTEM, TM 10-8470-210-10 | | EA | |

END OF WORK PACKAGE

**OPERATOR MAINTENANCE
IMPROVED OUTER TACTICAL VEST GEN III
ADDITIONAL AUTHORIZATION LIST (AAL)**

ADDITIONAL AUTHORIZATION LIST (AAL)

INTRODUCTION

Scope

This work package lists additional items you are authorized for the support of the IOTV Gen III.

General

This list identifies items that do not have to accompany the IOTV Gen III and that do not have to be turned in with it. These items are all authorized to you by CTA, MTOE, TDA, or JTA.

Explanation of Columns in the AAL

Column (1) National Stock Number (NSN). Identifies the stock number of the item to be used for requisitioning purposes.

Column (2) Description, Part Number/(CAGEC). Identifies the Federal item name (in all capital letters) followed by a minimum description when needed. The last line below the description is the part number and the Commercial and Government Entity Code (CAGEC) (in parentheses).

Column (3) Usable On Code. When applicable, gives you a code if the item you need is not the same for different models of equipment.

Column (4) U/I. Unit of Issue (U/I) indicates the physical measurement or count of the item as issued per the National Stock Number shown in column (1).

Column (5) Qty Recm. Indicates the quantity recommended.

Table 1. Additional Authorization List.

| (1) National Stock Number (NSN) | (2) Description, Part Number/(CAGEC) | (3) Usable On Code | (4) U/I | (5) Qty Recm |
|--|--|-----------------------------|------------|--------------------|
| 8470-01-520-7360 | INSERTS, ENHANCED SMALL ARMS (ESAPI) (XS), CO/PD 04-10/(81337) | | ea | |
| 8470-01-520-7370 | INSERTS, ENHANCED SMALL ARMS (ESAPI) (S), CO/PD 04-10/(81337) | | ea | |
| 8470-01-520-7373 | INSERTS, ENHANCED SMALL ARMS (ESAPI) (M), CO/PD 04-10/(81337) | | ea | |
| 8470-01-520-7385 | INSERTS, ENHANCED SMALL ARMS (ESAPI) (L), CO/PD 04-10/(81337) | | ea | |
| 8470-01-520-7382 | INSERTS, ENHANCED SMALL ARMS (ESAPI) (XL), CO/PD 04-10/(81337) | | ea | |
| 8470-01-536-7227 | INSERTS, SMALL ARMS PROTECTIVE (ESBI) , (ONE SIZE), CO/PD 06-20/(81337) | | ea | |
| 8470- 01-547-9555 | INSERTS, X SMALL ARMS PROTECTIVE (XSAPI) XS | | ea | |
| 8470-01-547-9722 | INSERTS, X SMALL ARMS PROTECTIVE (XSAPI) S | | ea | |
| 8470-01-547-9726 | INSERTS, X SMALL ARMS PROTECTIVE (XSAPI) M | | ea | |
| 8470-01-547-9779 | INSERTS, X SMALL ARMS PROTECTIVE (XSAPI) L | | ea | |
| 8470-01-547-9780 | INSERTS, X SMALL ARMS PROTECTIVE (XSAPI) XL | | ea | |
| 8470-01-589-0176 | INSERTS, X SIDE BALLISTIC (XSBI) ONE SIZE | | pr | |
| 8470-01-604-6905 | SPARE PARTS KIT, OCP IOTV GEN III (20 EACH: EMERGENCY RELEASE ASSEMBLY, WEBBING HANGER, FEMALE BUCKLE, ADJUSTABLE, MALE BUCKLE, REPAIRABLE, SIDE PLATE CARRIER POCKET) | | | |

END OF WORK PACKAGE

**OPERATOR MAINTENANCE
IMPROVED OUTER TACTICAL VEST GEN III
EXPENDABLE AND DURABLE ITEMS LIST**

EXPENDABLE AND DURABLE ITEMS LIST**INTRODUCTION****Scope**

This work package lists expendable and durable items that you will need to operate and maintain the IBA. This list is for information only and is not authority to requisition the listed items. These items are authorized to your by CTA 50-970, Expendable/Durable Items (Except Medical, Class V Repair Parts, and Heraldic Items), CTA 50-909, Field and Garrison Furnishings and Equipments or CTA 8-100, Army Medical Department Expendable/Durable Items.

Explanation of Columns in the Expendable/Durable Items List

Column (1) Item No. This number is assigned to the entry in the list and is references in the narrative instructions to identify the item (e.g., Use brake fluid (WP 0098, item 5)).

Column (2) Level. This column identifies the lowest level of maintenance that requires the listed item (include as applicable: C= Crew, O = Service/AMC, F = Field/ASB, H = Below Depot, D = Depot).

Column (3) National Stock Number (NSN). This is the NSN assigned to the item which you can use to requisition it.

Column (4) Item Name, Description, Part Number (CAGEC). This column provides the other information you need to identify the item. The last line below the description is the part number and the Commercial and Government Entity Code (CAGEC) (in parentheses).

Column (5) U/I. Unit of Issue (U/I) Code. Shows the physical measurement or count of an item, such as gallon, dozen, gross, etc.

Table 1. Expendable and Durable Items List

| (1) Item No. | (2) Level | (3) National Stock Number (NSN) | (4) Item Name, Description, Part Number/(CAGEC) | (5) U/I |
|--------------------|--------------|---------------------------------------|--|------------|
| 1 | C | 8315-01-222-0680 | Kit, Sewing, A-A-55190 (58536) | EA |
| 2 | C | Local Purchase | Soap, Mild | BX |
| 3 | C | 7510-00-266-5016 | Tape, Pressure Sensitive Adhesive, PPP-T-60 (81348) or similar | RL |

END OF WORK PACKAGE

**OPERATOR MAINTENANCE
IMPROVED OUTER TACTICAL VEST GEN III
SUPPORT ITEMS**

INTRODUCTION

This work package lists items you will need to maintain the IOTV Gen III. The list is for information purposes only and is not authority to requisition replacements.

Table 1. Additional Items List.

| (1) ITEM NO. | (2) DESCRIPTION, PART NUMBER/(CAGEC) | (3) UI | (4) NATIONAL STOCK NUMBER (NSN) |
|-----------------------------|---|-------------------|--|
| 1 | BRUSH 7920-00-282-2470/83421 | EA | 7920-00-282-2470 |
| 2 | MULTI-TOOL, Folding, Pocket 68010201K/OCAD1 | EA | 5110-01-474-0894 |

END OF WORK PACKAGE

These are the instructions for sending an electronic 2028

The following format must be used if submitting an electronic 2028. The subject line must be exactly the same and all fields must be included; however only the following fields are mandatory: 1, 3, 4, 5, 6, 7, 8, 9, 10, 13, 15, 16, 17, and 27.

From: "Whomever" <whomever@avma27.army.mil>
To: TACOMLCMC.DAForm2028@us.army.mil

Subject: DA Form 2028

1. From: Joe Smith
2. Unit: home
3. Address: 4300 Park
4. City: Hometown
5. St: MO
6. Zip: 77777
7. Date Sent: 19-OCT-93
8. Pub no: 55-2840-229-23
9. Pub Title: TM
10. Publication Date: 04-JUL-85
11. Change Number: 7
12. Submitter Rank: MSG
13. Submitter FName: Joe
14. Submitter MName: T
15. Submitter LName: Smith
16. Submitter Phone: 123-123-1234
17. Problem: 1
18. Page: 2
19. Paragraph: 3
20. Line: 4
21. NSN: 5
22. Reference: 6
23. Figure: 7
24. Table: 8
25. Item: 9
26. Total: 123
27. Text:

This is the text for the problem below line 27.

| | | | | | | | |
|---|-----------|------------|------------|--|--|--|-------------------------|
| RECOMMENDED CHANGES TO PUBLICATIONS AND BLANK FORMS | | | | | | Use Part II (reverse) for Repair Parts and Special Tool Lists (RPSTL) and Supply Catalogs/Supply Manuals (SC/SM). | DATE 21 October 2003 |
| For use of this form, see AR 25-30; the proponent agency is ODISC4. | | | | | | | |
| TO: (Forward to proponent of publication or form) (Include ZIP Code) U.S. Army TACOM Life Cycle Management Command, ATTN: AMSTA-LCL-MPP / TECH PUBS 6501 E. 11 Mile Road, Warren, MI 48397-5000 | | | | | | FROM: (Activity and location) (Include ZIP Code) PFC JANE DOE Co A 3 RD Engineer Br. Ft Leonard Wood, MO 63108 | |
| PART I – ALL PUBLICATIONS (EXCEPT RPSTL AND SC/SM) AND BLANK FORMS | | | | | | | |
| PUBLICATION/FORM NUMBER TM 10-1670-296-20&P | | | | DATE 30 October 2002 | TITLE Unit Manual for Ancillary Equipment for Low Velocity Air Drop Systems | | |
| ITEM NO. | PAGE NO. | PARA-GRAPH | LINE NO. * | FIGURE NO. | TABLE NO. | RECOMMENDED CHANGES AND REASON (Provide exact wording of recommended changes, if possible). | |
| | 0036 00-2 | | | | 1 | <p><i>In Table 1, Sewing Machine Code Symbols, the second sewing machine code symbol should be MDZZ not MD22</i></p> <p><i>Change the manual to show Sewing Machine, Industrial: Zig-Zag; 308 stitch; medium-duty; NSN 3530-01-181-1421 as a MDZZ code symbol.</i></p> | |
| <i>*Reference to line numbers within the paragraph or subparagraph.</i> | | | | | | | |
| TYPED NAME, GRADE OR TITLE Jane Doe, PFC | | | | TELEPHONE EXCHANGE/AUTOVON, PLUS EXTENSION (508) 233-4141 DSN 256-4141 | | SIGNATURE Jane Doe <i>Jane Doe</i> | |

| | | | | | | | | | |
|--|-----------------|-----------------|------------------------------|---|---|-----------------|---|---|--|
| TO: (Forward direct to addressee listed in publication) U.S. Army TACOM Life Cycle Management Command, ATTN: AMSTA-LCL-MPP / TECH PUBS 6501 E. 11 Mile Road, Warren, MI 48397-5000 | | | | | FROM: (Activity and location) (Include ZIP Code) PFC JANE DOE Co A 3 RD Engineer Br. Ft Leonard Wood, MO 63108 | | | DATE 21 October 2003 | |
| PART II – REPAIR PARTS AND SPECIAL TOOL LISTS AND SUPPLY CATALOGS/SUPPLY MANUALS | | | | | | | | | |
| PUBLICATION NUMBER TM 10-1670-296-20&P | | | | | DATE 30 October 2002 | | TITLE Unit Manual for Ancillary Equipment for Low Velocity Air Drop Systems | | |
| PAGE NO. | COLM NO. | LINE NO. | NATIONAL STOCK NUMBER | REFERENCE NO. | FIGURE NO. | ITEM NO. | TOTAL NO. OF MAJOR ITEMS SUPPORTED | RECOMMENDED ACTION | |
| 0066 00- | | | | | 4 | | | <i>Callout 16 in figure 4 is pointed to a <u>D-Ring</u>. In the Repair Part List key for Figure 4, item 16 is called a <u>Snap Hook</u>. Please correct one or the other.</i> | |
| PART III – REMARKS (Any general remarks or recommendations, or suggestions for improvement of publications and blank forms. Additional blank sheets may be used if more space is needed.) | | | | | | | | | |
| | | | | | | | | | |
| TYPED NAME, GRADE OR TITLE | | | | TELEPHONE EXCHANGE/AUTOVON, PLUS EXTENSION | | | SIGNATURE | | |

| | | |
|---|---|------|
| <p align="center">RECOMMENDED CHANGES TO PUBLICATIONS AND BLANK FORMS</p> <p>For use of this form, see AR 25-30; the proponent agency is ODISC4.</p> | Use Part II (reverse) for Repair Parts and Special Tool Lists (RPSTL) and Supply Catalogs/Supply Manuals (SC/SM). | DATE |
|---|---|------|

| | |
|---|---|
| TO: (Forward to proponent of publication or form) (Include ZIP Code) U.S. Army TACOM Life Cycle Management Command, ATTN: AMSTA-LCL-MPP / TECH PUBS 6501 E. 11 Mile Road, Warren, MI 48397-5000 | FROM: (Activity and location) (Include ZIP Code) |
|---|---|

PART I – ALL PUBLICATIONS (EXCEPT RPSTL AND SC/SM) AND BLANK FORMS

| | | |
|--|-------------------------|--|
| PUBLICATION/FORM NUMBER TM 10-8470-210-10 | DATE 1 December 2012 | TITLE Operator's Manual for Improved Outer Tactical Vest Gen III (IOTV GEN III) |
|--|-------------------------|--|

| ITEM NO. | PAGE NO. | PARA-GRAPH | LINE NO. * | FIGURE NO. | TABLE NO. | RECOMMENDED CHANGES AND REASON (Provide exact wording of recommended changes, if possible). |
|----------|----------|------------|------------|------------|-----------|--|
| | | | | | | |

**Reference to line numbers within the paragraph or subparagraph.*

| | | |
|----------------------------|--|-----------|
| TYPED NAME, GRADE OR TITLE | TELEPHONE EXCHANGE/AUTOVON, PLUS EXTENSION | SIGNATURE |
|----------------------------|--|-----------|

| | | |
|---|---|-------------|
| TO: <i>(Forward to proponent of publication or form)</i> <i>(Include ZIP Code)</i> U.S. Army TACOM Life Cycle Management Command, ATTN: AMSTA-LCL-MPP / TECH PUBS 6501 E. 11 Mile Road, Warren, MI 48397-5000 | FROM: <i>(Activity and location)</i> <i>(Include ZIP Code)</i> | DATE |
|---|---|-------------|

PART II – REPAIR PARTS AND SPECIAL TOOL LISTS AND SUPPLY CATALOGS/SUPPLY MANUALS

| PUBLICATION NUMBER TM 10-8470-210-10 | | | | | DATE 1 December 2012 | | TITLE Operator's Manual for Improved Outer Tactical Vest Gen III (IOTV GEN III) | |
|---|----------|----------|-----|---------|-------------------------|----------|--|--------------------|
| PAGE NO. | COLM NO. | LINE NO. | NSN | REF NO. | FIGURE NO. | ITEM NO. | TOTAL NO. OF MAJOR ITEMS SUPPORTED | RECOMMENDED ACTION |
| | | | | | | | | |

PART III – REMARKS *(Any general remarks or recommendations, or suggestions for improvement of publications and blank forms. Additional blank sheets may be used if more space is needed.)*

| | | |
|----------------------------|--|-----------|
| TYPED NAME, GRADE OR TITLE | TELEPHONE EXCHANGE/AUTOVON, PLUS EXTENSION | SIGNATURE |
|----------------------------|--|-----------|

| | | |
|---|---|------|
| <p align="center">RECOMMENDED CHANGES TO PUBLICATIONS AND BLANK FORMS</p> <p>For use of this form, see AR 25-30; the proponent agency is ODISC4.</p> | Use Part II (reverse) for Repair Parts and Special Tool Lists (RPSTL) and Supply Catalogs/Supply Manuals (SC/SM). | DATE |
|---|---|------|

| | |
|---|---|
| TO: (Forward to proponent of publication or form) (Include ZIP Code) U.S. Army TACOM Life Cycle Management Command, ATTN: AMSTA-LCL-MPP / TECH PUBS 6501 E. 11 Mile Road, Warren, MI 48397-5000 | FROM: (Activity and location) (Include ZIP Code) |
|---|---|

PART I – ALL PUBLICATIONS (EXCEPT RPSTL AND SC/SM) AND BLANK FORMS

| | | |
|--|-------------------------|--|
| PUBLICATION/FORM NUMBER TM 10-8470-210-10 | DATE 1 December 2012 | TITLE Operator's Manual for Improved Outer Tactical Vest Gen III (IOTV GEN III) |
|--|-------------------------|--|

| ITEM NO. | PAGE NO. | PARA-GRAPH | LINE NO. * | FIGURE NO. | TABLE NO. | RECOMMENDED CHANGES AND REASON <i>(Provide exact wording of recommended changes, if possible).</i> |
|----------|----------|------------|------------|------------|-----------|---|
| | | | | | | |

**Reference to line numbers within the paragraph or subparagraph.*

| | | |
|----------------------------|--|-----------|
| TYPED NAME, GRADE OR TITLE | TELEPHONE EXCHANGE/AUTOVON, PLUS EXTENSION | SIGNATURE |
|----------------------------|--|-----------|

| | | |
|---|---|-------------|
| TO: <i>(Forward to proponent of publication or form)</i> <i>(Include ZIP Code)</i> U.S. Army TACOM Life Cycle Management Command, ATTN: AMSTA-LCL-MPP / TECH PUBS 6501 E. 11 Mile Road, Warren, MI 48397-5000 | FROM: <i>(Activity and location)</i> <i>(Include ZIP Code)</i> | DATE |
|---|---|-------------|

PART II – REPAIR PARTS AND SPECIAL TOOL LISTS AND SUPPLY CATALOGS/SUPPLY MANUALS

| PUBLICATION NUMBER TM 10-8470-210-10 | | | | | DATE 1 December 2012 | | TITLE Operator's Manual for Improved Outer Tactical Vest Gen III (IOTV GEN III) | |
|---|----------|----------|-----|---------|-------------------------|----------|--|--------------------|
| PAGE NO. | COLM NO. | LINE NO. | NSN | REF NO. | FIGURE NO. | ITEM NO. | TOTAL NO. OF MAJOR ITEMS SUPPORTED | RECOMMENDED ACTION |
| | | | | | | | | |

PART III – REMARKS *(Any general remarks or recommendations, or suggestions for improvement of publications and blank forms. Additional blank sheets may be used if more space is needed.)*

| | | |
|----------------------------|--|-----------|
| TYPED NAME, GRADE OR TITLE | TELEPHONE EXCHANGE/AUTOVON, PLUS EXTENSION | SIGNATURE |
|----------------------------|--|-----------|

By Order of the Secretary of the Army:

RAYMOND T. ODIERNO
General, United States Army
Chief of Staff

Official:

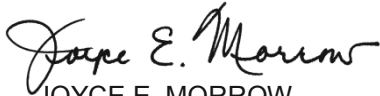

JOYCE E. MORROW
Administrative Assistant to the
Secretary of the Army
1231014

Distribution: To be distributed in accordance with Initial Distribution
Number (IDN) 257959 requirements for TM 10-8470-210-10.

The Metric System and Equivalents

Linear Measure

1 centimeter = 10 millimeters = .39 inch
 1 decimeter = 10 centimeters = 3.94 inches
 1 meter = 10 decimeters = 39.37 inches
 1 dekameter = 10 meters = 32.8 feet
 1 hectometer = 10 dekameters = 328.08 feet
 1 kilometer = 10 hectometers = 3,280.8 feet

Weights

1 centigram = 10 milligrams = .15 grain
 1 decigram = 10 centigrams = 1.54 grains
 1 gram = 10 decigrams = .035 ounce
 1 dekagram = 10 grams = .35 ounce
 1 hectogram = 10 dekagrams = 3.52 ounces
 1 kilogram = 10 hectograms = 2.2 pounds
 1 quintal = 100 kilograms = 220.46 pounds
 1 metric ton = 10 quintals = 1.1 short tons

Liquid Measure

1 centiliter = 10 milliliters = .34 fl. ounce
 1 deciliter = 10 centiliters = 3.38 fl. ounces
 1 liter = 10 deciliters = 33.81 fl. ounces
 1 dekaliter = 10 liters = 2.64 gallons
 1 hectoliter = 10 dekaliters = 26.42 gallons
 1 kiloliter = 10 hectoliters = 264.18 gallons

Square Measure

1 sq. centimeter = 100 sq. millimeters = .15 sq. inch
 1 sq. decimeter = 100 sq. centimeters = 15.5 sq. inches
 1 sq. meter (centare) = 100 sq. decimeters = 10.76 sq. feet
 1 sq. dekameter (are) = 100 sq. meters = 1,076.4 sq. feet
 1 sq. hectometer (hectare) = 100 sq. dekameters = 2.47 acres
 1 sq. kilometer = 100 sq. hectometers = .386 sq. mile

Cubic Measure

1 cu. centimeter = 1000 cu. millimeters = .06 cu. inch
 1 cu. decimeter = 1000 cu. centimeters = 61.02 cu. inches
 1 cu. meter = 1000 cu. decimeters = 35.31 feet

Approximate Conversion Factors

| <i>To change</i> | <i>To</i> | <i>Multiply by</i> | <i>To change</i> | <i>To</i> | <i>Multiply by</i> |
|------------------|--------------------|--------------------|--------------------|---------------|--------------------|
| inches | centimeters | 2.540 | ounce-inches | newton-meters | .007062 |
| feet | meters | .305 | centimeters | inches | .394 |
| yards | meters | .914 | meters | feet | 3.280 |
| miles | kilometers | 1.609 | meters | yards | 1.094 |
| square inches | square centimeters | 6.451 | kilometers | miles | .621 |
| square feet | square meters | .093 | square centimeters | square inches | .155 |
| square yards | square meters | .836 | square meters | square feet | 10.764 |
| square miles | square kilometers | 2.590 | square meters | square yards | 1.196 |
| acres | square hectometers | .405 | square kilometers | square miles | .386 |
| cubic feet | cubic meters | .028 | square hectometers | acres | 2.471 |
| cubic yards | cubic meters | .765 | cubic meters | cubic feet | 35.315 |
| fluid ounces | milliliters | 29.573 | cubic meters | cubic yards | 1.308 |
| pints | liters | .473 | milliliters | fluid ounces | .034 |
| quarts | liters | .946 | liters | pints | 2.113 |
| gallons | liters | 3.785 | liters | quarts | 1.057 |
| ounces | grams | 28.349 | liters | gallons | .264 |
| pounds | kilograms | .454 | grams | ounces | .035 |
| short tons | metric tons | .907 | kilograms | pounds | 2.205 |
| pound-feet | newton-meters | 1.356 | metric tons | short tons | 1.102 |
| pound-inches | newton-meters | .11296 | | | |

Temperature (Exact)

| | | | | |
|----|-------------|-----------------|-------------|----|
| °F | Fahrenheit | 5/9 (after | Celsius | °C |
| | temperature | subtracting 32) | temperature | |

PIN: 089729-000