

# ARMOR



## Crisis in Battle: The Conduct of the Assault

## Introducing ARMOR's New Editor-in-Chief

# Let Us Continue the Dialogue

*The author, Major Terry A. Blakely, joined the Armor Staff this month as the magazine's 38th Editor-in-Chief.*

Sitting here picking prairie grass out of my bootlaces and knocking the dust off my BDUs, I look around and see for the first time a new set of surroundings. A new building, new subordinates, new job, and a new parking place. Now I must get into a car — no HMMWV with this job — in order to see or hear the familiar high-pitched whine of turbine engines. It takes a few minutes now to find a good whiff of what I call the smell of freedom, JP-8 fuel burning into exhaust gases. The motor pool and the field are no longer a short walk away. Frankly, the changes are somewhat disconcerting. However, as I turn from a window view of a parking lot and family housing and gaze inward, the unsettled feeling begins to fade. All the trappings of the well-used military office are present, so it certainly isn't their presence that puts me at ease. It is the bottom shelf of the bookcase by the desk that gives the first clue that all will be well.

On the bottom shelf is a complete set of this magazine, and according to my predecessor, every issue from the March 1888 issue of the *Journal of the United States Cavalry Association*, highlighting a debate on whether the cavalry trooper should carry a saber or revolver as his primary armament, to the March/April 1995 *ARMOR* issue featuring specs on the latest Russian main battle tank. In between are years and years of accumulated knowledge about, well, everything our branch is: mud, cold biting winds, teamwork, maintenance, POL, new equipment, variations of tactics, techniques, and procedures, probably some more mud, hot canteens, cold coffee, thrown tracks, first round hits, successful breaches, numbing shock effects, NTC OPFOR, historical pieces, and book reports. And more. When I see that, reassurance sweeps over me.

This editor's desk will be a good fit — it is a well-worn prop — and certainly it has an air of permanence to it. It will last longer than me, just as it has survived longer than any of the other temporary editors. The whole office feels the same way. There isn't much in need of radical change around here. Sure, I'll put my set of 1980's-vintage Armor Association Karen Randall prints on the walls to mark my territory (I'm set #132), and I'll bring in some of

my most treasured martial texts to spruce up the tops of the bookcases, but the bottom line feeling I get is the same. I'm the current caretaker for a living, lasting piece of our profession's intellectual development. That is an exciting and humbling charge.

The last few years have amply demonstrated that there is only one fact that any of us can bet on. Whatever our plans, the future international events that will call us tankers and cavalymen to action defy accurate prediction. That is a fact of professional military life. If we know and accept that change is the only constant, we all should be able to keep focus, and not be consumed by downsizings, restationings, closures, and all of the other distracters pulling our attentions away from the essential point of our existence. That is, we are to train to fight and win any battle on our terms. We must always be the team that has the most high-velocity, direct-fire cannons ready to fire into the engagement area at the decisive point and at the critical time. That is a challenging order to comply with, and one of the reasons why your magazine exists.

I will dedicate my efforts and rededicate those of the very small, but highly competent *ARMOR* staff to maintaining this journal's focus on warfighting matters. We welcome suggestions and material from the field for it is our lifeblood.

The exchange of ideas is only as powerful as the power of those exchanging the ideas, so I ask each of you to convince others, be they fellow armored soldiers or interested academicians, to participate here in this dialogue of ideas. I believe there is something of interest for every armored soldier in this issue. If they have already chosen to subscribe, that is fine, but at a minimum, the force needs you to get those people to read a unit copy and pass it on — or recycle your own. We will stay ahead of the vagaries of change if all of us cross the line of departure together with extensive crew drills behind us and ready for whatever the battlefield throws at us.

—TAB

By Order of the Secretary of the Army:

GORDON R. SULLIVAN  
General, United States Army  
Chief of Staff

Official:

  
JOEL B. HUDSON  
Acting Administrative Assistant to the  
Secretary of the Army

00243

# ARMOR

*The Professional Development Bulletin of the Armor Branch PB-17-95-4*

Editor-in-Chief

**MAJ TERRY A. BLAKELY**

Managing Editor

**JON T. CLEMENS**

Commandant

**BG LON E. MAGGART**

*ARMOR* (ISSN 0004-2420) is published bimonthly by the U.S. Army Armor Center, 4401 Vine Grove Road, Fort Knox, KY 40121.

Disclaimer: The information contained in *ARMOR* represents the professional opinions of the authors and does not necessarily reflect the official Army or TRADOC position, nor does it change or supersede any information presented in other official Army publications.

Official distribution is limited to one copy for each armored brigade headquarters, armored cavalry regiment headquarters, armor battalion headquarters, armored cavalry squadron headquarters, reconnaissance squadron headquarters, armored cavalry troop, armor company, and motorized brigade headquarters of the United States Army. In addition, Army libraries, Army and DOD schools, HQ DA and MACOM staff agencies with responsibility for armored, direct fire, ground combat systems, organizations, and the training of personnel for such organizations may request two copies by sending a military letter to the editor-in-chief.

Authorized Content: *ARMOR* will print only those materials for which the U.S. Army Armor Center has proponentcy. That proponentcy includes: all armored, direct-fire ground combat systems that do not serve primarily as infantry carriers; all weapons used exclusively in these systems or by CMF 19-series enlisted soldiers; any miscellaneous items of equipment which armor and armored cavalry organizations use exclusively; training for all SC 12A, 12B, and 12C officers and for all CMF-19-series enlisted soldiers; and information concerning the training, logistics, history, and leadership of armor and armored cavalry units at the brigade/regiment level and below, to include Threat units at those levels.

Material may be reprinted, provided credit is given to *ARMOR* and to the author, except where copyright is indicated.

**July-August 1995, Vol. CIV No. 4**

## Features

- 6 Crisis in Battle: The Conduct of the Assault**  
by Major David J. Lemelin
- 15 The Armor Lieutenant and the M1A2**  
by First Lieutenant Robert S. Krenzel, Jr.
- 26 Reverse Dejá Vù**  
by Paul S. Meyer
- 27 Company Command in Korea**  
by Captain Bradley T. Gericke
- 30 Light Armor Units: An Italian Perspective**  
by Colonel Sergio Fiorentino
- 33 Depleted Uranium Without the Rocket Science**  
by Captain Pat Paulsen
- 35 The Lessons of Operation Desert Hammer VI: Our Doctrine Is Basically Sound**  
by Major Jeffrey R. Witsken
- 38 Protect the Force (The Firefinder Radar System)**  
by Major Michael S. Jacobs and Captain Robert H. Risberg
- 42 Two Stakes in Tandem Help Eliminate Danger of Falling Antennas**  
by Lieutenant Colonel David M. Fiedler
- 43 Training in a Low Budget Environment**  
by Major Armor D. Brown, Major Clarence E. Taylor, and Major Robert R. Leonard
- 48 A Mini Tank Range, Step by Step**  
by Captain Gregory M. Parrish

**Back Cover A Patton Museum Guide Book**

## Departments

- 2 Contacts**
- 3 Letters**
- 4 Commander's Hatch**
- 5 Driver's Seat**
- 52 Books**

Second-class official mail postage paid at Fort Knox, KY, and additional mailing offices. Postmaster: Send address changes to Editor, *ARMOR*, ATTN: ATZK-ARM, Fort Knox, KY 40121-5210.

Distribution Restriction: Approved for public release; distribution is unlimited.

USPS 467-970

# DIRECTORY — Points of Contact

## ARMOR Editorial Offices

**Editor-in-Chief**  
Major Terry A. Blakely 2249  
E-Mail: BLAKELYT@KNOX-EMHI.ARMY.MIL

**Managing Editor**  
Jon T. Clemens 2249

**Editorial Assistant**  
Vivian Oertle 2610

**Production Assistant**  
Mary Hager 2610  
E-Mail: HAGERM@KNOX-EMHI.ARMY.MIL

**Staff Illustrator**  
Mr. Jody Harmon 2610

**PHONE INFORMATION:** Phone extensions for points of contact are listed at right of name. (Note: Fort Knox Defense Switch Network (DSN) prefix is 464. Commercial prefix is Area Code 502-624-XXXX).

**MAILING ADDRESS:** ARMOR: ATTN: ATZK-ARM, Fort Knox, KY 40121-5210.

**ARTICLE SUBMISSIONS:** To improve speed and accuracy in editing, manuscripts should be originals or clear copies, either typed or printed out double-spaced in near-letter-quality printer mode. We also accept stories on 3½ or 5¼-inch floppy disks in MultiMate, WordStar, Microsoft WORD, WordPerfect, Ami Pro, XyWrite, Microsoft Word for Windows, and ASCII (please include a double-spaced printout). Please tape captions to any illustrations submitted.

**SUBMISSION POLICY NOTE:** Due to the limited space per issue, we will not print articles that have been submitted to, and accepted for publication by, other Army journals. *Please submit your article to only one Army journal at a time.*

**PAID SUBSCRIPTIONS/ST. GEORGE-ST. JOAN AWARDS:** Report delivery problems or changes of address to Connie Bright or Susanne Lane, P.O. Box 607, Ft. Knox, KY 40121 or call (502) 942-8624, FAX (502) 942-6219.

**UNIT DISTRIBUTION:** Report delivery problems or changes of address to Mary Hager, DSN 464-2610; commercial: (502) 624-2610. Requests to be added to the free distribution list should be in the form of a letter to the Editor-in-Chief.

**ARMOR HOTLINE — DSN 464-TANK:** The Armor Hotline is a 24-hour service to provide assistance with questions concerning doctrine, training, organizations, and equipment of the Armor Force.

## U.S. ARMY ARMOR SCHOOL

**Commandant** (ATZK-CG)  
BG Lon E. Maggart 2121  
E-Mail: MAGGART@KNOX-EMHI.ARMY.MIL

**Assistant Commandant** (ATSB-AC)  
7555

**Director of the Armor School** (ATSB-DAS)  
COL Fred A. Treyz III 1050  
E-Mail: TREYZ@KNOX-EMHI.ARMY.MIL

**Command Sergeant Major**  
CSM Ronnie W. Davis 4952  
E-Mail: POSTCSM@KNOX-EMHI.ARMY.MIL

**Armor School Sergeant Major**  
CSM Jeffery L. Richardson 5405  
E-Mail: RICHARDJ@KNOX-EMHI.ARMY.MIL

**16th Cavalry Regiment** (ATSB-SBZ)  
COL Don Elder 7848  
E-Mail: ELDER@KNOX-EMHI.ARMY.MIL

**1st Armor Training Brigade** (ATSB-BAZ)  
COL Henry Hodge 6843  
E-Mail: HODGE@KNOX-EMHI.ARMY.MIL

**Directorate of Combat Developments** (ATZK-CD)  
COL Edward A. Bryla 5050  
E-Mail: BRYLAE@KNOX-EMHI.ARMY.MIL

**NCO Academy** (ATZK-NC)  
CSM John E. Barnett 5150  
E-Mail: BARNETTJ@KNOX-EMHI.ARMY.MIL

**Reserve Component Spt Div** (ATZK-PTE)  
LTC Bennett J. Mott 1351  
E-Mail: MOTTB@KNOX-EMHI.ARMY.MIL

**TRADOC System Manager for Abrams and Armored Gun System** (ATZK-TS)  
COL John F. Kalb 7955  
E-Mail: KALB@KNOX-EMHI.ARMY.MIL

**Mounted Battlespace Battle Lab** (ATZK-MW)  
COL G. Patrick Ritter 2139  
E-Mail: RITTER@KNOX-EMHI.ARMY.MIL

**Office, Mounted Battlespace Integration** (ATZK-AR)  
COL Gary Krueger 7809  
E-Mail: KRUEGER@KNOX-EMHI.ARMY.MIL  
**FAX 7585**

# LETTERS

## Complexities of WWII Armor

Dear Sir:

The January-February 1995 issue of *ARMOR* with Mr. Halbert's review of my book, *Standard Guide to U.S. World War II Tanks and Artillery*, just reached the top of my reading pile. I appreciate the review and its kind words.

I also appreciate Mr. Halbert's "only real criticism" of the book. Since his review appeared in an important professional journal, I think it warrants an explanation of why I did not include either tank armor thickness data or armor-piercing ammunition, or any other terminal ballistics characteristics.

Let me preface my remarks by stating that I served in World War II and in the U.S. Army Ordnance Department. I also graduated from the U.S. Army Ordnance School at Aberdeen Proving Ground.

Regarding tank armor thickness: The widely used World War II U.S. Army technical manual TM 9-2800, *Standard Motor Vehicles*, did not include this information. It is found in the technical manuals for every model and variation of tank with a listing of eight armor thicknesses for the hull and turret. In special Ordnance Department publications, additional variations in armor thicknesses are mentioned as having been the result of changes made in production without effecting parts and assembly interchangeability. Modification Work Orders that were followed in the overhaul and upgrading of tanks mention further changes in armor resulting from such things as welded-on applique armor.

In the case of the some 55,000 M4 Shermans built during World War II, for example, a very complicated page or so of armor thickness statistics would be required to state all those required, and I felt this would add little to the understanding of U.S. Army World War II tanks in the concise review of the subject I present. I did consider using the World War II British "armor basis" system of doing it, but since the U.S. Army of World War II neither liked or used it, I chose not to.

In regard to U.S. World War II armor-piercing ammunition terminal ballistics, the situation is equally complex. There were several basic types of armor-piercing ammunition used, including AP armor-piercing shot, APC armor-piercing capped shot and HVAP high velocity armor-piercing shot, and each of these had its own special armor-piercing characteristics. Over the course of World War II, changes in both armor-piercing projectiles and the propelling charges were made which affected the armor penetration, creating additional statistics.

During World War II, the U.S. Army Ordnance Department Technical Intelligence people reported that, in any case, the ar-

mor penetration data presented was unreliable. The problem was that enemy tanks' armor varied considerably in the type of steel used, the way it was processed, and in quality, all of which affected the effect of armor-piercing projectiles on it. A large amount of complex and confusing data would have been required to explain this and I chose not to include it since I felt it would add little to my basic objective of presenting the subject in a simple and concise way.

My basic objective in writing the book was to present a complete and concise review of the materiel the U.S. Armed Forces used in World War II, because this had never been done. There have been, for example, books published on specific U.S. Army World War II tanks, such as the M4 Sherman, which include information on both the armor and main gun armor-penetration characteristics, and these show just how complex these characteristics were.

I hope you understand this explanation, and that you and other readers will find the book useful as the concise overall review of its subject it is intended to be.

KONRAD F. SCHREIER JR.  
Los Angeles, Calif.

## Pitfalls of Armor Comparisons

Dear Sir:

In regard to the book review of *Standard Guide to U.S. World War II Tanks and Artillery*, p. 52. I partially agree with the reviewer's comment that the book would have been enhanced by including armor thickness and penetration data, but there are pitfalls in doing that. The only really meaningful comparison of terminal ballistic data is of data gathered under a closely controlled series of tests run by a competent, unbiased test organization. To compare one set of ballistic data from a source of undetermined accuracy and credibility, insufficient detailed information about the ammo and the armor quality (often **wartime** ammo and armor), unknown standards for 'success' of either the ammo or the armor, uncertain date, and usually unknown weather conditions, with another set of ballistic data with equally vague test conditions, often from another country, is to truly 'compare apples and oranges.'

Another point often lost in comparing such data is that to **defeat the armor** (put a hole in it) is not the same thing as **defeating the system** ('knocking out' the system, or better, destroying it.)

Nonetheless, authors will often struggle to include such data. Some will do a reasonably good job, and others will not. My concern is that the readers will fail to understand just how little faith one can put in

such comparisons unless one is comparing systems of grossly unequal capability.

For those with interest in more detail about the U.S. 76mm HVAP performance against Panther and Tiger tanks, as well as a great deal more about U.S. tank and tank destroyer weapons in WWII, I strongly recommend *Faint Praise: American Tanks and Tank Destroyers in World War II*, Charles M. Baily (Yes, there is no 'e' in this Baily!), Archon Books, Shoe String Press, Inc., Hamden, Conn. Excellent, compact, and inexpensive.

DONALD J. LOUGHLIN  
Antioch, Calif.

## The Cav Gunner's Full Plate

Dear Sir:

It is a well known fact that, as a master gunner, the learning does not stop once you leave the classroom. This is especially true for a cavalry scout (19D) master gunner. The position of a cavalry troop master gunner is considered an extra duty; they must still fulfill the duties of section sergeants and platoon sergeants. This makes time management critical and, if not managed properly, will greatly affect a gunnery program.

Another consideration is the fact that a single cavalry troop usually consists of 13 Bradley Fighting Vehicles, nine Abrams tanks, two mortar carriers, and several other assets. On top of this, the squadron that this troop is part of may have as many as three troops of attack helicopters under its colors as well. This brings a whole new perspective to the cavalry master gunner. As the troop Bradley master gunner, I feel it is my responsibility to ensure killing success for my troop's Bradleys on the battlefield. To achieve success on the battlefield, the cavalry truly uses the combined arms concept, combining fires on their targets, thus causing a swift, violent conclusion to any engagement, allowing minimal friendly loss and minimum time, if any, for the enemy to report their contact to their higher, as well as other reasons. Because of the way the cavalry coordinates fires from all of its fighting assets simultaneously on the battlefield to achieve total victory, I must now better understand the characteristics and capabilities of all the assets my troop utilizes on the battlefield. This brings yet another great challenge to both the tank and the Bradley master gunners in both gaining the needed knowledge and coordination of these assets to train and work as a cohesive team.

*Continued on Page 23*

*BG Lon E. Maggart  
Commanding General  
U.S. Army Armor Center*

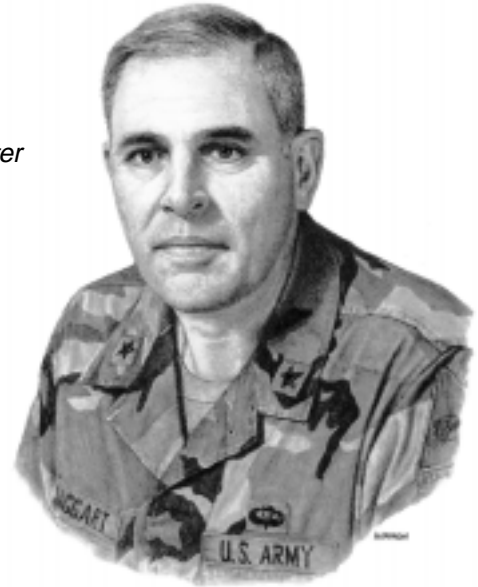

## Warfighting Spirit

The mounted force has been the focal point for change in the Army over the past three years, and for good reason. Historically, the mounted force was the one place in the Army where soldiers were trained to close with and destroy the enemy and to use high technology equipment. By design and mission, mounted soldiers were — and remain — masters in achieving decisive results using state-of-the-art equipment on rapidly changing and often ambiguous battlefields.

The modern battlefield demands mounted warfighters capable of thinking decisively, moving rapidly, and improvising quickly. The ability to respond rapidly and correctly to multiple, often conflicting, situations while moving over unfamiliar terrain joins audacity, courage, innovation, and tenacity as mandatory characteristics of the mounted warfighter.

Since the days of Adna Chaffee, mounted soldiers have experimented with ideas of how to better use their equipment to destroy the enemy faster and more efficiently. Mounted soldiers have no trouble discarding conventional, accepted practices in favor of innovative ones that work better on the battlefield. Change has been the norm for mounted soldiers. Here, it is not by accident that mounted warfighters are leading the way in building Force XXI.

This fact is no more evident than at the home of mounted warfare, Fort

Knox, Kentucky. Buildings and classrooms here are filled with simulators that have harnessed the power of technology to train the force. The Virtual Training Program uses these tools to teach reserve and active units how to boldly execute the fight. The emerging Force XXI Training Program will soon give brigade and lower commanders the ability to train the entire combined arms team in ways not now possible.

The Mounted Battlespace Battle Lab is using digitally equipped simulations and current and future operational software in Advanced Warfighting Experiment (AWE) Focused Dispatch to determine the organization, tactics, techniques, and procedures for TF XXI, the digital brigade. The Director of Combat Developments is pushing the technological envelope on the requirements for the future tanks and scout vehicles that will be needed in the twenty-first century.

At the same time, Fort Knox is the Army's pioneer for distance learning techniques and simulation-based training programs for the commander and his staff. Classroom XXI, an innovative education and training program using distance learning, is up and running in the Armor School. The Advanced Warfighting Working Group is busy exploring dynamic ideas and concepts for fighting on the digital battlefield of the next century. The 1st Armor Training Brigade uses computer-driven simula-

tors to teach initial entry soldiers how to drive a tank with increased proficiency and at lower cost. Our professional civilian work force provides the technical expertise and continuity necessary to sustain these programs over the long haul. Like the mounted force at large, The Center for Mounted Warfare is **about** change.

But in the midst of all this change, there remains one constant: **the soldier**. Make no mistake about it, technological advances, new equipment, virtual reality simulations, and training programs are essential tools for the mounted soldier. They define mounted warfare. But never forget that the Republican Guards were defeated by the imagination, daring, skill and the indomitable spirit of the mounted warfighter, not by computers.

In the final analysis, the mounted force is about dedicated and trained soldiers who are willing to sacrifice for their Country. The challenge for the mounted force, from now into the next century, will be to use new technology, doctrine, weapons, equipment, and training programs to produce warfighters who are technically qualified; warfighters, filled with the legendary spirit of the mounted soldier; warfighters who know and love the smell of battle and who have the courage and technical competence to move to the sound of the guns. This is our challenge, pure and simple. **ON THE WAY!**

CSM Ronnie W. Davis  
Command Sergeant Major  
U.S. Army Armor Center



## Armor/Cavalry ANCOC Shaping Future Platoon Sergeants

The Army exists to deter war or, if deterrence fails, to win in combat. Only a platoon that is well trained, effectively led, and highly motivated will survive and win in battle. The Armor Advanced Noncommissioned Officer's Course (ANCOC) at the Armor Center, Fort Knox, is charged with, and committed to, producing platoon sergeants who will mold, lead, train, and motivate the soldiers who will man those platoons.

This is the fourth and final article in a series highlighting the institutional training provided at the Armor Center and Noncommissioned Officer's Academy. The purpose of this article is to provide you an overview of the training your future platoon sergeant receives and inform you of what you can expect from this ANCOC graduate once he reports for duty.

I believe it's important you understand the type of individual responsible for training our future platoon sergeants, and what it takes to become an ANCOC instructor. Many factors are considered before selecting an ANCOC instructor. First, there is a thorough records screening. Foremost and above all, an NCO must have served successfully as a platoon sergeant and be a graduate of the ANCOC course. We want quality NCOs who have distinguished themselves as platoon sergeants to train our future leaders. Once accepted, an NCO will go through a

minimum of three months of intensive train-up as an instructor before he gets the opportunity to hang up his shingle. During those three months he will learn training techniques on how to conduct small group training sessions, Video-Tele-Teach conferences, and will also learn the Systems Approach to Training. All Armor ANCOC instructors are thoroughly prepared to teach doctrine and are up-to-date on the use of modern technology. They understand where the Army and the armor force are headed, and have the focus and ability to prepare students for their entry into the twenty-first century. Rest assured that our new, potential platoon sergeants are being trained by some of the best and brightest senior NCOs.

Now, let's look at today's ANCOC student. Considering the select-train-promote philosophy of the Army's personnel management system, the average armor ANCOC student of today is a staff sergeant in his mid-to-late twenties. He has been in the force for approximately 12 years and his time in grade varies between four and six years. He has been a successful tank commander or scout section leader and has demonstrated the potential to become an effective tank or cavalry platoon sergeant. The majority of students come directly from TOE units; however, a small percentage are just coming off recruiter or drill sergeant assignments and look forward to learning

new warfighting skills. This is the average student.

Now, let's look at the course. ANCOC is the third level of the Noncommissioned Officer's Education System (NCOES). The skills trained here build on those learned in previous NCOES courses and the students' personal experiences. The course is varied and in-depth, but primarily focuses on supervisory, management, and administrative skills. The MOS 19K ANCOC course is 12 weeks and the MOS 19D course is 14 weeks. Both courses follow the same curriculum when it comes to some instructional areas. An example is Common Leader Training, where some of the same subjects (NCOERs, awards, counseling, etc.) taught at lower level courses are revisited, but with more of an emphasis and focus on the supervisory level. Later in the course, the MOSs diverge into their own specialties.

Part of the course is devoted to weapons training. A portion of this instruction focuses on the student's ability to plan, design, and conduct live-fire ranges. This includes the set-up and conduct of live-fire preparatory requirements such as the Tank Crew Gunnery Skills Test and Bradley Gunnery Skills Test. Another facet of this instruction trains Unit Conduct of Fire Trainer

*Continued on Page 22*

# Crisis in Battle: The Conduct of the Assault

by Major David J. Lemelin

*“Crossing the hostile fire zone until our own fire can begin will always constitute a crisis in the engagement.”*

— von Moltke<sup>1</sup>

Closing with an enemy in a prepared position is a fundamental task that lies at the heart of our profession. This task is also, almost unquestionably, the most difficult and potentially dangerous of all combat missions. Surprisingly, however, despite its criticality, it is also one of the least practiced of all the tasks for which a mechanized unit trains. Institutional experience at the training centers further demonstrates that when units execute this task, they are rarely successful. As one senior observer/controller at the National Training Center put it, “It is almost as if mounted units are uncomfortable with the assault, so they avoid it in planning and rehearsal, as if subordinate leaders will inherently know how to execute.”<sup>2</sup>

Army doctrine is also “uncomfortable” with the assault. Several manuals address it under various guises: actions on the objective, attack to seize an objective, how to assault, etc. However, most manuals give only a cursory and incomplete outline of this difficult and essential task. There exists no single source that discusses this task in sufficient detail for a mechanized team commander to be able to adequately plan, prepare, and execute this mission. The following is an attempt to collate existing information from several, disparate sections of several manuals and then overlay historical experience and common sense to create a “fleshed-out” view of the planning, preparation, and execution of a combined-arms company-level assault of a prepared position.<sup>3</sup>

By way of definition (an essential starting point for any tactical discus-

sion), the term “assault of an objective” or simply the “assault” means the entry into and overrunning of an enemy position. “Attack” is a broader term that includes all activity from roughly the Line of Departure forward, including assaults along the way or possibly culminating in an assault and the subsequent, anticipated pursuit. “Actions on the objective” is a term that implies tasks accomplished after an objective is secured. What we are really discussing when we talk about the conduct of the assault is a tactical problem that is as old as projectile weapons — how to close with a defending enemy, under the fire of his weapons, to the point that the inherent advantages of the defense are obviated. The infantry community, borrowing a term from the pre-WWII German General Staff, refers to this problem as “the last 300 yards.”<sup>4</sup> Given the increased range of weapons since WWII, the modern phrase should more likely be “the last 1000 meters.” Whatever the distance, the problem is fundamentally the same. Significantly, the German term for it from Clausewitz to the present has remained unchanged, they call it, “Krise im Gefecht” — the crisis in battle.

As a further introduction to this problem, a brief discussion of the terms “hasty” and “deliberate” is in order. In order to assault a prepared enemy position a certain amount of intelligence is always required. In optimal circumstances, a unit will have intelligence detailing such things as design of trench lines and fighting positions, vehicle and major weapons system positions, location and composition of protective obstacles, etc., in enough time for the assault force commander to rehearse the assault plan for those specific conditions. Further, he would have this information in enough time to task-organize at the lowest levels for specific actions on that particular objective. Command and control (C<sup>2</sup>) measures can be less restrictive in this instance because difficulties in C<sup>2</sup> during

execution will be compensated for through detailed rehearsals. This situation, where the assaulting force has the luxury of detailed preparation and task organization, can be termed a “deliberate” assault.

In many — possibly most — instances, this kind of time will not be available. The requisite intelligence on the enemy position may only be gained through binoculars from a support-by-fire position minutes before the assault must commence. In this case, the assault force commander must enhance command and control through relatively restrictive control measures and fight with existing or habitual task organizations. This situation may be termed a “hasty” assault. However, it is vital to understand that the fundamental methodology for the conduct of an assault is the same regardless of how long a unit has to prepare. Accompanying the necessity for an operation of this nature is the need for a requisite amount of intelligence. A unit cannot be sent against a prepared enemy defense with any expectation of success without some degree of knowledge of the enemy’s dispositions. Even with limited time, the methodical, coordinated use of the combined arms is fundamental to success. We do not assault “on line” as a method to make up for lack of intelligence. This desperate expedient, as history repeatedly demonstrates, leads to failure and exorbitant losses. Experience also shows that units must follow up this initial failure with something they should have done in the first place, a planned and coordinated assault. The following is an attempt to illustrate a routine methodology that is not dependent on preparation time, but solely on adequate intelligence.

The vehicle for this discussion of the assault will be a mechanized company-team with tank and armored (BFV) infantry platoons. The focus of the discussion is on how the commander of



---

this assault force plans for the coordinated use of tanks, BFVs, dismounted infantry, and indirect fires. The assault may be part of a larger, more complex task force breaching operation. In this situation, the assault must be coordinated with the actions of sister units breaching and supporting. Given an adequate combat power ratio, the assault is conducted against a company objective without external assistance.

In any case, a unit plans for the objective assault first, for several reasons. First, with limited planning time available, the unit must focus on the most critical tasks. By definition, if we are committing our assets to an assault, then it must be a critical task. Second, the way in which a unit will conduct its assault drives how the rest of the attack leading up to the assault occurs. If any activity during the attack is going to be “swagged,” it cannot be this one. The preceding phases of an attack should be designed to give the assault force the greatest positional advantage possible. These phases should also seek psychological advantage (often closely related to positional advantage) for the assaulting force. That is, to make the enemy commander think he cannot hold his position and attempt to withdraw, thus the attack would optimally transition to pursuit rather than assault.

The relationship between reconnaissance and planning for the assault is so critical that it requires further amplification. The assault force must have a thorough knowledge of the enemy’s disposition before committing to action. In the best circumstances, scouts or other dedicated reconnaissance assets have detailed the enemy position. The assault force commander and his leaders have also conducted a leaders’ recon of the objective in ample time for thorough preparation back in the assembly area. The assault force should, however, be prepared for considerably less than the best circumstances. In many situations, the recon elements will be relaying their reports to the assault force once the attack is under way, and the assault force commander will only get a visual recon through binoculars from a support-by-fire position. So, a unit gleans information from scouts early in the planning stage. In less than optimal circumstances, units get it from an advance guard once the attack is under way. In worst case, the

assault force must conduct its own reconnaissance just prior to execution of the assault. In all cases, the assault force has the requisite intelligence of the objective, even if a momentary, local pause in the overall attack is required. History shows that the momentum of an attack is slowed much more drastically by a failed assault than by a brief reconnaissance to ensure the assault’s success. The old adage that “time spent on reconnaissance is never time wasted,” is never more applicable. So, the real variable in the conduct of an assault is time for preparation. But, as we shall see, a thorough understanding of the tactical problems of the assault by combat leaders in peacetime can mitigate the lack of preparation time.

The assault force commander, now equipped with a mental — and, preferably, graphic — picture of the objective, must plan his assault. The first consideration is the decisive point of the objective. The decisive point is an enemy force or piece of terrain that, if controlled or destroyed, will greatly enhance the success of the operation.<sup>5</sup> Since success is tied to achievement of the mission’s purpose, the commander must understand why he is conducting the assault. Given the intrinsic risk of such an operation, a commander should commit to an assault only if it is required for success. Generally, the commander will be told the effect he is to achieve on the enemy force or the terrain on his objective. “Seize” and “clear” are typical terrain-oriented missions that require occupation of terrain. Therefore, an assault must be planned if the enemy desires to retain that terrain. The missions “destroy” and “fix” may require an assault if the terrain and situation will not allow these effects to be achieved by fire only. Given the above, the commander can specify the decisive point on the objective.

The commander develops a scheme of maneuver that masses his combat power at the decisive point as early in the assault as possible. By definition, mass at the decisive point will lead to early success and possibly considerable damage to the enemy’s will. This psychological edge, in the best case, will drive the enemy to consider the position untenable and attempt withdrawal. Even in the worst case, if the assault force masses combat power at the deci-

sive point and the enemy does not withdraw or give up, the positional advantage the assault force gains by control of the decisive point will make the remainder of the assault considerably easier. In any situation, the ultimate goal of mass at the decisive point during the assault is to eliminate the need for further assaulting and the associated loss of time and resources.

Planning backward from the decisive point, the commander assesses the overall enemy situation. He must determine if a mounted assault is possible or if a dismounted assault is necessary. By “mounted” or “dismounted” we simply mean whether the assault force can enter the enemy position initially with armored vehicles or must penetrate with dismounted infantry. The exigencies of the situation could cause the assault force to dismount or remount anytime during the assault because the commander is always looking for an opportunity to get armored vehicles behind the enemy position. Whether these vehicles go through or around the objective is less important than that they attain the advantages associated with being between the enemy and his withdrawal route. “Positions are seldom lost because they have been destroyed, but almost invariably because the leader has decided in his own mind that the position cannot be held.”<sup>6</sup> This aside for the moment, the following set of factors will determine the unit’s initial posture for the assault.

As a mechanized force, we prefer to assault mounted and should look for every opportunity to do so. The protection afforded by the armor on the M1A1 and the BFV is infinitely preferable to BDUs and Kevlar. Additionally, as discussed earlier, we are trying to get our vehicles and their combat potential behind the enemy as soon as possible. So, the mechanized commander should look first to see if a mounted assault is possible and only assault dismounted, risking his few and highly-prized infantry, if the situation dictates such a difficult venture.

When making this decision, the assault force commander must first consider the terrain. The enemy entrenchments, protective obstacles, and close terrain (e.g. heavy vegetation and built-up areas) may prevent armored vehi-

---

cles from traversing the objective. Un-suppressed antitank weapons are an obvious deterrent to mounted assault; however, the commander probably will not be able to assess this factor until the operation is under way. Smaller antitank weapons such as RPGs, however, may not deter an assault by heavily armored MIAIs. It is important to understand here that, if the initial entry is to be mounted, then tanks will lead. They may be followed by BFVs, but because of their superior survivability if the enemy gets off the first shot, tanks must be in the van.

The presence of antitank weapons notwithstanding, the commander may still elect to assault mounted if the enemy defense has lost its coherence. Evaluating the coherence of the enemy defense is one of the assault force commander's critical tasks throughout the operation. The "coherence" of a defense is the defender's ability to shift, focus, and redistribute fire where needed, as well as reposition assets to cope with new threats. It is this coherence that generally precludes a mounted assault and makes it necessary to assault dismounted, in an effort to disrupt that coherence. Once the combined effects of dismounted maneuver and supporting fire defeat the enemy's ability to defend in this coordinated manner, the assault force commander should be ready to send his armor instantly through or around to the rear of the position.

The final point on the question of mounted or dismounted assault is that the nature of the mission may require dismounted clearing of the enemy position regardless of the previously discussed factors. Alternately, the initial assault to the far side of the enemy's position may not eliminate the relevance of that position. In these situations, an initial assault by tanks should be followed by BFVs. The infantry then dismounts behind the enemy and assaults his entrenchments from the rear or an undefended flank. The advantages of assaulting from this direction are obvious; however, the commander must be circumspect in how and when he sends the thinly armored BFVs across those "last 300 yards."

For either assault, but especially for a dismounted one, the commander must

find a point on the ground to "enter" the enemy position. In the case of a dismounted assault, the basis for the rest of our discussion, this point is literally the point that the infantry will enter the trenchline. Backward planning from the decisive point, the commander looks for a weakness in the enemy defense that is as close as possible to the decisive point, since it generally follows that the less fighting and expenditure of resources prior to the attack on the decisive point, the better. A weakness in the enemy defense may be a point at which the terrain affords a covered or concealed route up to the enemy position, or a point at which the enemy can only bring a limited amount of fire to bear. Common sense tells us that a well prepared enemy defense probably does not have an obvious weak point or not, at least, one that can be determined without extensive, detailed reconnaissance.

The assault force commander should always look for some means to enter the enemy position through stealth or infiltration. Failing this, he will in many, if not most, situations have to create a weak point, even if the weakness is only temporary. He creates this weak point by isolating a small enemy sub-unit or position from the rest of the enemy defense. The chief means for effecting this isolation is, of course, through direct and indirect fire suppression. The assault force commander must plan for adequate suppressive fires to prevent other enemy elements from interfering or otherwise influencing the assault force's combat power superiority at the entry point and from the dismounted or mounted approach to the entry point. Indirect fires and smoke, when properly adjusted, further suppress the enemy and isolate the entry point and its approaches from observation by the enemy as well as from his fires.

After mission analysis, the assault force commander develops his scheme of maneuver. He has at hand, from this analysis, the enemy's disposition on the objective, the nature of the terrain leading up to and on the objective, the decisive point for the mission, a designated entry point, and whether or not a dismounted assault is necessary. As repeatedly emphasized earlier, the commander must have this information prior to execution. The variable in the

operation is the length of time available to prepare for the assault. With ample time for training and rehearsal, the assault force can task organize to platoon and even section/squad level so that each subordinate element is precisely organized for its tasks during the assault. Subsequent rehearsal together will overcome the unfamiliarity of such a detailed task organization and the consequent command and control difficulties. If the assault element has little or no time for preparation, then it must employ existing and familiar task organizations and not create units whose ad hoc nature will exacerbate an already difficult C<sup>2</sup> problem.

The other element of the scheme of maneuver that is driven by available preparation time is command and control, specifically the level of centralization. Simplistically, command and control is a sliding scale of centralization with emphasis on unity of effort at one end and emphasis on subordinate initiative on the other. The commander starts the operation at some point on the scale. This starting point depends on a set of factors. During the operation, the level of centralization of command and control will move up or down the scale based on changes in those same factors. Those factors include knowledge of the enemy, the nature of the operation and its complexity, the time available to plan and prepare for the operation, and the friendly-to-enemy combat power ratio. Command and control, in most cases — regardless of what point on the scale it is when the operation starts — will eventually move toward unity of effort. The prime goal of combat is superior concentration at the decisive point, and, unless one has an initially overwhelming combat power ratio, unity of effort of multiple sub-units will ultimately be required to achieve that superiority.

Clearly, the assault of a prepared enemy position by mounted and dismounted elements is a very complex operation; therefore, it will be initially more centralized than most. If the assault force can thoroughly rehearse all its actions, then the commander can reduce his direct control of subordinate elements. Further, he can maximize his use of smoke and obscurants since rehearsals will compensate for the smoke's degrading effect on C<sup>2</sup>. With little or no preparation time, the assault

*"Suppression is a psychological phenomenon whose effect is temporary. Soldiers, either dismounted or mounted, will not expose themselves to what they think is deadly fire. So, as Rommel and others have pointed out, the accuracy of the fire is less important than the volume..."*

force commander will have to be very directive in order to unify the efforts of all his subordinates. He will also have to be judicious in his use of smoke. In any case, the nature of the assault requires close and constant coordination of the above- and below-ground battles, especially during the time when the infantry is closing on the objective.

The assault force commander may start the operation at a point that is well on the "subordinate initiative" side of the scale. If he has inadequate knowledge of the enemy situation, he must give some subordinate elements freedom of action to conduct reconnaissance until the situation clarifies, then shift back toward the "unity of effort" side of the scale to conduct the assault. This assumes, of course, that the friendly-to-enemy combat power ratio is such that one properly organized subordinate element cannot conduct the assault alone, in which case the commander remains on the subordinate initiative side and continues to keep the reins loose.

When planning the scheme of maneuver, the commander must plan for the "above-ground" and the "below-ground" battles. The below-ground battle is the clearing of the enemy trenches, bunkers, and fighting positions. It is fought by dismounted infantry and engineers. Squad automatic weapons, demolitions, grenades, and bayonets are the primary weapons employed. To reiterate a point made earlier, the most critical phase of this battle (if below-ground fighting is necessary at all) is the crossing of the last "300 yards" to begin the below-ground battle. This battle is fought in a one-directional, systematic manner. The infantry can clear the trench to envelop the decisive point from a flank, clear directly to the decisive point from the entry point, then clear the remainder of the trench, or clear from front-to-rear or rear-to-front, attacking the decisive point as it occurs geographically. (Each enemy trench system will have to be evaluated for the most advantageous method.) The infantry must clear along the trench, in one direction, in a "leap-frog" fashion, marking intersections as they go in order to ensure their "rear" is always secure and to prevent fratricide by converging friendly units. Squad-level trench clearing techniques are adequately covered in several manuals,<sup>7</sup> so, suffice to say that trench

clearing is a physically-exhausting, ammunition-intensive operation. Despite this fact, however, fewer infantrymen in the trench line is often better, as FM 7-10, *The Infantry Rifle Company*, states, "Often, a small assault element supported by a large volume of suppressive fires is effective..."<sup>8</sup> This apparent dichotomy is not surprising if one remembers that the width of a well constructed trench will accommodate only one man at a time. So, the trench clearing drills revolve around this lead man and his volume of fire. The rest of the element is essentially in support of this one man, rotating forward as needed, and providing rear security, demolition teams, grenade throwers, evacuation teams, ammo bearers, etc.

The below-ground battle, as indicated, is the exclusive realm of the infantry platoon leader and his subordinate squad and team leaders. This battle is fought on a very intense and personal level, with little margin for error. The above-ground battle, on the other hand, is the commander's battle. This battle sets the terms for the below-ground fight and, if executed properly, greatly reduces its difficulty. In the best circumstance, a successful above-ground battle obviates the need for further below-ground fighting by forcing an enemy withdrawal or pushing tanks to the rear of the position. The above-ground battle is also concerned with isolation of the objective and securing the whole from enemy reserves or other repositioning forces. In this battle, the commander plans for the coordination of the below-ground battle with tank and BFV platoons, mortar and artillery fires, and direct fire support from sister units. The above-ground activity is the "fire" of the "fire and movement" that is the assault and, as such, has as its chief aim — suppression.

The criticality of suppressive fire, especially direct fire, cannot be understated. Once the necessity for an assault is determined, especially an initially dismounted assault, the mission hinges on the commander's planning for and execution of direct fire suppression from good support-by-fire positions. At its simplest, suppressive fire is the "fire" of the fire and maneuver of a fire team. In the context of a mechanized assault, suppressive fire is the means to solve the "crisis in battle." As stated,

rarely does the terrain or the nature of the enemy's defensive position allow a "covered" crossing of the terrain from the assault position to the entry point. Therefore, the element that physically closes this distance will be exposed to enemy fire. If the assaulting element is dismounted, as we have seen it often must be, the success or failure of the entire operation depends on getting the infantry across these "last 300 yards." Once they are in the trenches, their battle is on much more even terms. Therefore, the scheme of maneuver must ensure that, not only are the tanks and BFVs in position, but that indeed the enemy is not returning fire before the dismounted infantry begins its move from the assault position or across the probable line of deployment (PLD).

A word on the nature of suppression is in order. S.L.A. Marshall, in *Men Against Fire*, says that the relationship between fire and movement is so interwoven that "to fire is to move."<sup>9</sup> That is, good suppressive fire allows freedom of movement and, conversely, soldiers and units move to get better firing positions. Suppression is a psychological phenomenon whose effect is temporary. Soldiers, either dismounted or mounted, will not expose themselves to what they think is deadly fire. So, as Rommel and others have pointed out, the accuracy of the fire is less important than the volume.<sup>10</sup> The rounds do not have to hit the enemy, but he must think he is going to be hit. The fear of death and maiming is the essence of suppressive fire. The soldier is convinced that getting up or moving out of defilade to fire himself is not worth the risk of death.

The fact that MILES lasers do not kill or harm is the reason that the primacy of suppressive fire is lost in training. Fire directed in the vicinity of the enemy will achieve suppression for the simple reason that he does not know that you do not know where he is exactly located. He only knows that he is being shot at with potentially deadly effect. Whether or not we choose to acknowledge it, indirect fire's greatest value is not in its destructive effect but in its ability to suppress, a fundamental truth lost in training. The explosions of mortar and artillery rounds will suppress armored forces because of the psychological impact of the detonations themselves. Even 25-mm high explo-

---

sive rounds, while not tank-killing rounds, can also suppress armored forces until the enemy determines the type munitions being fired at him and realizes it is not too threatening. As realization dawns, fear diminishes, and so does the suppressive effect. For this reason, veteran units are harder to suppress because they will more quickly identify what type of fire is threatening to them and what is not.

When planning for direct fire suppression of the enemy in the above-ground battle, the commander must consider first the positioning of his tank and BFV platoons. In general, the line from these support-by-fire positions to the enemy position should be at as great an angle as possible from the line the infantry will move along from assault position to the entry point. There are two reasons for this separation: one, the enemy's attention will be focused on the mounted elements and not on the relatively vulnerable infantry; thus, the infantry may achieve local surprise; two, once the infantry enters the trench, the enemy will be caught on those ever-sought-after "horns of a dilemma." That is, every action he takes to avoid the direct fire from tanks and BFVs, such as stay in defilade or down in his bunkers, makes him vulnerable to attack from infantry moving down the trench line. Conversely, actions he takes to avoid the attacking infantry and indirect fire, such as repositioning or withdrawing, leaves him vulnerable to the fires from the support-by-fire positions. Finally, the commander must give as much latitude as necessary to tank and BFV platoon leaders so that they can reposition and "jockey around" to ensure they have the requisite line of sight to their portions of the objective. These leaders must understand that this line of sight is essential and it is their duty to find a position from which to achieve the desired effect on the enemy.

The second consideration for direct fire suppression is volume of fire. The commander must estimate for how long the enemy must be suppressed and then take steps to ensure proper fire distribution and appropriate rate of fire throughout this time period. He does this primarily by designating the critical events during the assault and ensuring that the highest rate of fire is available then. He may also direct

other techniques for ensuring continuous direct fire suppression. For example, he may specify rounds fired per minute, per vehicle, or specify fire by alternate sections, or specify certain elements to provide a base of fire and others to provide overwatch.

More than any other event, the infantry's entry into the objective requires maximum direct fire suppression. During this critical period, the commander must specify that the tank and BFV platoons are providing support by fire as a "base of fire" in accordance with FM 71-1.<sup>11</sup> These elements are not waiting to identify enemy vehicles or positions, but are firing into the general vicinity of the enemy; volume over accuracy. Remember, he does not know they do not know where he is. The mission to support by fire as "overwatch" should only be assigned to individual vehicles and sections to conserve ammunition during less critical times during the assault, and then only after the infantry has entered the trench. The commander should also consider positioning ammunition resupply vehicles within reach of the tank and BFV platoons to speed up the reload process. Maintaining continuous fire is essential, but as the assault progresses, less fire will be necessary to maintain suppression as enemy elements are destroyed or withdraw. During the inevitable lulls in the direct fire suppression caused by the necessity to reload, the commander should redouble his use of indirect fire to maintain the suppressive effect. In the conduct of the dismounted assault, there is no substitute for establishing and keeping fire superiority, especially until the infantry has entered the trench. As Nathan Bedford Forrest so eloquently phrased it, "It's the first blow that counts; and if you keep it up hot enough, you can whip 'em as fast as they come up."

The commander and his fire support officer (FSO) develop the indirect fire plan to support the above- and below-ground battles. They also plan for the rigid control of indirect fires for the duration of the assault. Known or suspected enemy positions are targeted as are routes in and out of the enemy position. Again, the commander must estimate the duration of the assault and, specifically, the length of time it will take the infantry to get from assault position to entry point. This will ensure

indirect fire suppression and obscuration when the infantry is most vulnerable. In general, indirect fire suppression should begin simultaneously with the direct fire from support-by-fire positions. This initial phase, while the infantry is moving to its PLD or dismount point and making final preparations, should make maximum use of field artillery fires, with delay fuzing, for the purpose of actually destroying (the ultimate suppression) the enemy in position. Fires should initially concentrate on the enemy influencing the entry point, then as the infantry gets close, shifting to other enemy positions to increase the isolation of the entry point as discussed earlier. "Danger close" to dismounted infantry is 600 meters for 155-mm artillery and 107-mm mortars. Terrain depending, this planning factor may be increased or decreased to ensure the safety of the infantry from its own indirect fires, while still maintaining the suppressive effect on the enemy. When shifting indirect fires away from the infantry, the commander should step up the direct fire suppression on the enemy at or influencing the entry point. The best judge of when to shift both direct and indirect fires away from the entry point will be the leader of the dismounted element approaching it. On his order or signal the fire should shift, and the infantry will fire and maneuver this last short distance using their own small arms and possibly their supporting BFVs for suppression of the entry point.

Once the infantry is in the trench line, the FSO, with the XO as back-up, will adjust the indirect fire from an overwatch position, ensuring it stays forward of the progress of the below-ground battle. The purpose of fires at this point is suppression of enemy elements to prevent them from interfering with the infantry in the trench. Since the whole objective may be 600 meters or less in width, the whole assault may be done "danger close." Partially compensating for this risk to the infantry is the fact that they are fighting in a trench designed to protect infantry from artillery. Nonetheless, indirect fire suppression should be maintained in these subsequent phases using primarily mortars (with fuzing set to detonate on or above the ground) on the objective itself and artillery fires behind or

*Some type of reserve must be formed even in the clearest of enemy situations, for as the great von Moltke tells us: "The enemy usually has three courses of action open to him, and of these three he will choose the fourth."*

---

beyond the objective to prevent reinforcement. The situation may require the actual lifting of indirect fires or shifting of them off the objective altogether if our own infantry are endangered. In this case, the onus is on the tanks and BFVs to maintain suppression. To ensure the efficacy of both direct and indirect fires during execution, the commander must be in a position to judge the fires' effects throughout the objective area and be in constant communication with the FSO and the infantry fighting the below-ground battle.

In planning the assault, the commander must designate a reserve. The purpose of the reserve is, of course, for the commander to influence the battle with combat power once execution is under way. He influences the battle, in the best circumstances, by having a fresh force available to pursue a withdrawing enemy. In most circumstances, the commander needs to influence the battle when the untoward or unexpected occurs. In these cases, the reserve provides redundancy and uncommitted combat power. Factors that influence the make-up of the reserve are: knowledge of the enemy disposition and intentions and, simply, the number of things that can go wrong in the operation, the "what if's," if you will. Additionally, the commander, when designing his reserve, must have an armored force available — if not uncommitted, then at least alerted — to pursue. Enemy withdrawal from a position in actual combat is more frequent than in the defend-to-the-last-ATWESS training events, where death is not the result of "last stands."

We have established that an assault requires detailed knowledge of the enemy dispositions before it can be executed. We might conclude, based on the factors listed above, that a reserve is not necessary in this case. However, the enemy's intentions — that is, what he will do with his forces — are much harder to establish. Some type of reserve must be formed even in the clearest of enemy situations, for as the great von Moltke tells us: "The enemy usually has three courses of action open to him, and of these three he will choose the fourth." The inevitable unpredictable events in any battle, let alone one as inherently risky as an assault of a prepared position, require the com-

mander to build redundancy in his plan through designation of a reserve.

We have further established that the most critical event in a dismounted assault is getting the infantry from the assault position across the "last 300 yards." This event is also the most likely to go wrong. Therefore, part of the reserve for a dismounted assault should be infantry. The commander of an armor-heavy company/team may, for example hold one of his two infantry squads in reserve in the assault position so that if the assault fails at the entry point, he has not also lost all his infantry and can try again. However with the paucity of infantry available to him, he cannot afford to keep this squad uncommitted for long. So, as the rule goes, he will commit his reserves to the appropriate place on the battlefield as the situation clarifies. That is, once the lead squad enters the trench and the time for the potential crisis that would require an infantry reserve has passed, the commander can hand control of this squad back to the infantry platoon leader for use in his scheme of maneuver.

The commander may further designate one of his tank platoons as an additional reserve with an eye toward assaulting with tanks to a point beyond the objective as the opportunity presents itself. Given the situation, he may keep that platoon or a section of it uncommitted to ensure its availability when needed. The commander may also assume some risk by using a committed force as a reserve. If he feels he needs their firepower for suppression, the commander may commit those tanks to supporting by fire with the additional mission to be prepared for the mounted assault. This same element may be the pursuit force if that situation arises. The commander must always be aware of the risk of having a committed force also be the reserve. That is, even in a support-by-fire role, such a reserve may not be able to extricate itself when called upon.

An example scenario, albeit oversimplified, will serve to illustrate the concepts discussed previously and demonstrate control measures necessary for executing the assault. The use of a sketch is an essential technique for amplifying the scheme of maneuver to

platoon and squad leaders who need more detail than 1/50K scale provides. So, referring to the accompanying sketch, our assaulting force commander's mission is to seize Objective Orange in order to subsequently support by fire from the vicinity of the objective to assist an attack by a sister company on another objective to the northeast. So, the commander will look for the opportunity to establish tank and BFV support-by-fire positions for this supporting task as early in the operation as possible. His decisive point is tied to the purpose of his assault. In this instance it is to control the terrain on Objective Orange to provide supporting fire. The enemy force itself, in this case, is only relevant in its ability to interfere with the assault force commander's establishing support-by-fire positions.

After considering all of the previous, the commander concludes that control of the high ground on the northeast portion of the objective will allow him freedom of maneuver to support his sister unit's attack. Reconnaissance by the scouts and his own visual reconnaissance from an overwatching position allows the commander to determine the details of the enemy disposition. He sketches them as shown. He notes that the enemy's command post and reinforcing tank are also on the high ground. Massing combat power at this point, then, will result in control of the high ground and destruction or withdrawal of enemy assets critical to the defense's coherence. The commander determines this point to be the decisive one and designates the terrain encompassing the high ground, CP, and the tank position as Objective White.

The situation is such, with broken terrain on the objective, criss-crossing trenchworks and multiple, active anti-tank weapons, that the commander decides that an initially dismounted assault is necessary. He also determines that moving tanks around the objective is not immediately possible. Looking for a weak point at which to enter the enemy position, the commander notes that the enemy squad on the western side of Objective Orange cannot be supported by fire from the other two squads if the objective is assaulted from the west. Additionally, the woodland to the west of the objective provides a covered approach up to a point

---

closer to the objective than any other approach from any other direction. So, the commander decides to enter the objective at this western side and designates that enemy squad position as Objective Red. He further designates the remaining two enemy squads' positions as Objectives Green and Blue. Note that he includes in each objective those enemy elements and positions likely to be controlled by a common leader. Visual recon also helps the commander define the geographical parameters of each objective by terrain features recognizable on the ground. This delineation is more important to the supporting elements and less to the assaulting, because the supporting elements will be assigned responsibility for specific objectives in the above-ground battle, while the infantry in the below-ground fight have responsibility for the whole. In the below-ground battle, these objectives are more for common reference with the above-ground battle than they are for division of responsibility. This is so because the below-ground battle is a series of fluid drills that vary, based on known enemy locations (bunkers, vehicles, machine guns, etc.) and exigencies, not on artificial and possibly unrecognizable (to those in the trench) boundaries.

Our assault force commander has two M1A1 tank platoons (1st and 2nd), a BFV-equipped infantry platoon (3rd), and his own headquarters element, consisting of his tank, his XO's tank, and the FSO in a fire support vehicle. He now must allocate these assets to accomplish the mission. Given his knowledge of the enemy situation, the proportional range of unpredictable events, and the possible branches to the current situation, the commander designates two reserves. The first is one section of BFVs and its associated squad which will remain in the infantry platoon's assault position until released by the commander. This reserve exists for two reasons: one, if the initial assault to the entry point fails, or two, if the opportunity arises to move mounted around or behind the objective, this force can follow the tanks and complete the trench line assault from the rear. The second reserve is a tank section from 1st platoon to remain with the commander and be used to move quickly to bring additional suppressive firepower against

any enemy force on or beyond the objective as needed and to be prepared to move through or around Objective Orange.

Our commander also determines, through information gleaned from the scouts, that the high ground along Highway 22 affords excellent observation and fields of fire onto the objective. Accordingly, he plans his support-by-fire positions in the vicinity of Checkpoints (CPs) 1 and 2. He plans a company Assault Position on the reverse slope of the high ground south of Highway 22. He further plans an Assault Position for 3rd platoon west of Highway 10 in the woodline in the vicinity of CP 9. The commander plans positions for his subsequent support-by-fire mission at CPs 4, 6 and 7, north of Objective Orange. He also determines the line formed by these last three checkpoints as the limit of advance for his platoons. For emergencies, he plans an Objective Rally Point at the company Assault Position.

To control his all-important direct fire plan, the commander employs several direct fire control techniques and their associated control measures. First, he puts target reference points (TRPs) on each enemy position, or close to the position on a recognizable feature. It is essential that the commander ensure that each of his subordinates confirm that they can identify each TRP on the ground, either during a leaders' reconnaissance or once in support-by-fire positions. A small number of readily identifiable TRPs, combined with a thorough incorporation of the "quadrant" or similar technique in the company SOP, is a much more flexible and subtly redundant means of fire control than is a myriad of TRPs and sectors of fire.<sup>12</sup>

Regardless of specific technique, the optimal purpose of direct fire control measures is to ensure clear assignment of responsibility for all known or potential enemy positions and the rapid and accurate shifting, focusing, and redistribution of fires during execution. Our assault force commander has placed five TRPs on the objective, plotted on bunkers or berms that all leaders and gunners can recognize. Not shown on our sketch are other, similarly planned direct fire control meas-

ures on the flanks and beyond Objective Orange that support the company's follow-on, support-by-fire mission.

The commander develops his plan for the below-ground battle around which the rest of the scheme of maneuver will develop. Looking initially for a direct assault on the decisive point, Objective White, from the entry point, Objective Red, the commander determines this is not possible without attacking through Objective Green. Additionally, once Objective Green is seized, the enemy on Objective Blue is rendered irrelevant since mounted elements can be brought up around Red and White once they are seized without interference from Blue. The scheme of maneuver will include an eventual assault on Objective Blue, but only after White is seized and the mounted elements are beginning their subsequent mission from positions behind Objective White. Based on this plan, the commander plans his assault on Objective Red and the overall direct fire plan.

The commander divides his scheme of maneuver into four phases. The first phase comprises the movement from the company assault position to the support-by-fire positions at CP 1, 1st platoon (-), and CP 2, 2nd platoon, and the movement of 1st platoon to its assault position. This phase also includes the establishment of fire superiority and suppression by the tank platoons onto Objective Orange. The second phase is the assault, by 3rd platoon, to seize Objective Red. The third phase is the main attack through Objective Green to seize Objective White. The fourth phase is the movement of 1st platoon and the BFVs of 3rd platoon to support-by-fire positions behind the objective in the vicinity of CPs 4 and 6 and beginning to suppress the objective to the north. Simultaneously the infantry, with continued supporting fire from 2nd platoon, assaults to seize Objective Blue.

If written out, the details of the scheme of maneuver for the first three phases might look something like this:

**Phase I:** 1st PLT (-) moves to support-by-fire position vicinity of CP1 and suppresses the enemy on OBJ Red. Simultaneously, 2nd PLT establishes a support-by-fire position vicinity of CP 2 and suppresses the enemy on OBJ Green and White. Tank platoons plan

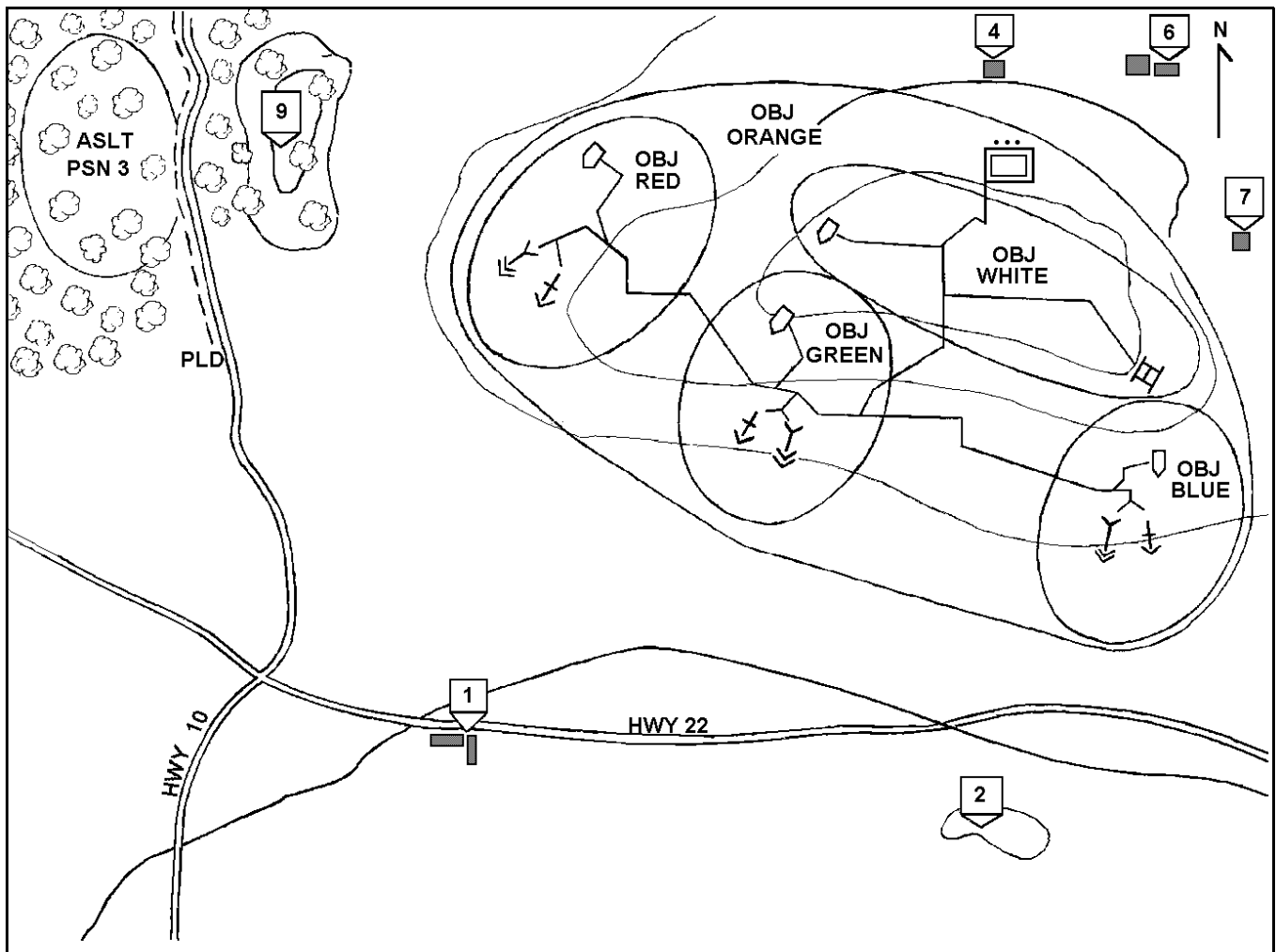

for maintaining suppression for 15 minutes until 3rd is ready to cross PLD and assault Red. 3rd platoon moves to Assault Position and 1st squad prepares to assault. Alpha section BFVs establish support-by-fire vicinity CP 3 to suppress Red and support dismounted assault as needed. Bravo section and 2nd squad remain in Assault Position as company reserve; be prepared to assume Alpha section mission.

XO move with 3rd platoon and be prepared to assist in suppression of Red from CP 3.

FSO establish overwatch vicinity of CP2. In this phase, artillery will neutralize Red, White, and Green, in that order of priority, and suppress Blue. Mortars will smoke the area between CP3 and Red and, as a deception measure, smoke east of Blue. CO and reserve tank section will move to and occupy a position behind CP 1 and be prepared to assist suppression of Red. Phase ends when 1st squad is ready to assault, and the enemy on Red, Green, and White are suppressed. 3rd will sig-

nal that they are set via FM and a red followed by green star cluster over CP3.

**Phase II:** At 3rd platoon's signal, the CO and reserve will move forward to assist 1st platoon in suppression of Red. 2nd will continue suppression of Green and White. On order, the infantry will cross the PLD and seize Red. 3rd platoon leader will signal for shifting of direct and indirect fire off of Red via FM, two red star clusters, and red smoke. At that signal, 1st platoon will shift to suppress Green, 2nd will shift to suppress White and Blue, CO and reserve will cease fire and move back. XO and Alpha section BFVs support by fire as needed by 3rd platoon leader. Bravo section will remain in Assault Position. Indirect fires will shift off of Red as stated, but will continue as in Phase I. Phase will end when Red is seized. 3rd will signal this via FM and yellow smoke from Red.

**Phase III:** This phase will begin, without pause from phase II, on the signal from 3rd platoon. 3rd will attack

to seize Green and White. They will mark forward progress of lead three-man team with orange flag on long-whip antenna extending above-ground and yellow smoke when each objective is seized. 1st platoon (-) will pause to rearm behind CP1, CO and reserve will move up and continue suppression of Green. 2nd will continue suppression of White and Blue. All direct fires will remain 50 meters ahead of 3rd platoon's signal flag. Bravo section will revert to 3rd platoon control in this phase.

Once 1st platoon (-) has rearmed and is back at CP 1, reserve tanks will be prepared to lead 3rd platoon BFVs under the XO's control in an assault from CP3 to CPs 4 and 5. FSO will lift fire off of Green at the beginning of this phase and continue mortar suppression of White and Blue. Lift fires off of White on signal from 3rd that Green is seized.

The reader gets the idea. A final note in this example is the positioning of the company leaders to provide redundant

command and control and observation of critical places on the battlefield. The CO is positioned to get as large a view as possible, but with control of the direct fire suppression as his focus. The FSO is positioned away from the CO for a necessarily redundant view of the objective, and to rigidly control the indirect fires to ensure suppression and avoid fratricide. The infantry platoon leader, in the trench with his trench clearing teams, is not in a position to accurately adjust the indirect fires, so this task is the focus of the FSO. As stated, the infantry platoon leader is in the trench with his dismounts because the below-ground battle is his platoon's critical task. As we have seen, the progress of the below-ground battle and signaling of that progress drives the entire direct and indirect fire plan. It is essential, therefore, that the platoon leader is present in the trench even though his actual span of control is limited to a few individuals. In general, the XO should be at the second most important place on the battlefield. In this case, he is positioned to closely monitor the progress of the infantry and provides the commander with another, closer view of the critical entry phase of the assault. He is also postured to provide supporting tank fire and lead a mounted assault following the infantry when the opportunity arises. The first sergeant, not specifically mentioned in our example, is forward with some capacity to quickly rearm the support-by-fire elements to preclude them from the time-consuming task of taking ammunition out of hull storage. He can put ammunition on his M113 as well as the maintenance track and the M88 recovery vehicle. If the situation allows, he might even control an ammunition-laden HEMMT behind the support-by-fire positions. The first sergeant's critical task is to monitor ammunition expenditure and prevent any pause in suppression because of ammunition shortages.

Before concluding, a final point on preparation is in order. Preparation for the assault must begin before planning — that is, in training in garrison or before commitment to battle. Given the fact that the commander may have little or no time available between planning and execution of the assault, he can minimize this difficulty by training that anticipates this mission. First and foremost, he and his leaders must thoroughly understand the nature of the assault mission and the considerations outlined above. The commander must train his company in standard and flex-

ible direct fire control techniques. His attached infantry must be well schooled in the team drills and individual tasks upon which every below-ground battle is based. Finally, he must habitually practice task-organizing at platoon level. Infantry and tank platoon leaders must know how to work with one another and with attached engineers, so that specific task organization for an assault is possible with little or no preparation time.

The principles of the assault outlined above are not intended to be applied blindly, as if they were some company battle drill. Like all doctrine, these principles are designed to educate the commander's judgement, not tell him what to do. However, these principles are of no value unless they are thoroughly assimilated. Frederick the Great summed it up nicely: "Gentleman, the enemy stands behind his entrenchments, armed to the teeth. We must attack him and win, or else perish... If you don't like this, you may resign and go home."<sup>13</sup>

As professionals, we must understand the assault, the most basic and most difficult of all missions. Merely hoping that we will know what to do when the situation arises is not a path to success. We must train ourselves, our leaders, and our soldiers in the conduct of the assault, or else we may as well "resign and go home."

## Notes

<sup>1</sup>Helmuth Graf von Moltke, *Moltke on The Art of War* (Presidio Press, Novato, Ca., 1993), p. 158.

<sup>2</sup>Colonel James B. Gunlicks, "Cobra Team" leader, Operations Group, National Training Center, Ft. Irwin, Ca., in an officer professional development session with Armor Officer Advance Course students, May, 1993.

<sup>3</sup>The following are some of the main doctrinal references on this subject :

FM 7-10, *The Infantry Rifle Company*, December, 1990, Chapter 4, pp. 4-22 to 4-32. This normally excellent manual, as usual, has the best description of this mission available. In this chapter, there is an excellent discussion of how a commander plans for an attack. However it "glosses over" the actual assault and jumps almost immediately from planning to consolidation on the objective. The section entitled "Assault of a Strongpoint" is good, but brief, and tends to treat the subject as a unique situation instead of a routine method for dealing with any enemy position.

FM 71-123, *Tactics and Techniques for Combined Arms Heavy Forces*, September, 1992,

Chapter 3, pp. 3-156-168. This section is highlighted by an excellent description of infantry trench clearing procedures.

FM 71-123, pp. 3-112 to 3-116. This section, "The Assault," delineates the difference between what occurs above and below ground. In combination with FM 7-10, this manual is the best available source for extrapolating a complete picture of the planning requirements for this mission.

FM 71-1, *The Tank and Mechanized Infantry Company Team*, November, 1988, pp. 3-26 to 3-27, "How to Assault" is far too brief. "Assault of a Fortified Strongpoint," pp. 3-40 to 3-51 concentrates almost exclusively on breaching.

FM 7-7J, *The Mechanized Infantry Platoon and Squad*, May 1993, "Battle Drill 6: Enter/Clear a Trench," pp. 3-38 to 3-43, good description of this critical task and the coordinated use of dismounted infantry and BFVs.

<sup>4</sup>John A. English, *On Infantry*, (Praeger, Westport, Conn., 1984), p. 49.

<sup>5</sup>For a discussion of the decisive point, see the author's article, "The Decisive Point," in the July-August 1994 issue of *ARMOR*.

<sup>6</sup>A.A. Vandegrift, as quoted in FM 1, *Warfighting*, p. 1.

<sup>7</sup>As stated above, FMs 7-10, 71-123, and 7-7J have good descriptions of trench clearing drills.

<sup>8</sup>FM 7-10, p. 4-29.

<sup>9</sup>S.L.A. Marshall, *Men Against Fire*, (Smith, Gloucester, Mass., 1978), p. 83. In Chapter 6, Marshall presents an excellent discussion of the relationship between fire and movement.

<sup>10</sup>Erwin Rommel, *The Rommel Papers*, (Harcourt, Brace, Jovanovich, New York, 1953), p. 7. Rommel repeatedly mentions the importance of initial fire superiority and the importance of volume over accuracy in the opening moments of an action.

<sup>11</sup>FM 71-1, pp. 3-23 to 3-25.

<sup>12</sup>An excellent discussion of direct fire control is found in Miller and Averna's article, "Direct Fire Planning," in the November-December 1993 issue of *ARMOR*.

<sup>13</sup>Frederick the Great, as quoted in the *Dictionary of Military and Naval Quotations*, ed. Robert Debs Heintz Jr. (United States Naval Institute, Annapolis, Md), p. 20.

Major David J. Lemelin is a small group instructor and team chief for the Armor Officer Advance Course at Ft. Knox. He has considerable command experience, including command during DESERT SHIELD and DESERT STORM. He is also the 1994 TRADOC Instructor of the Year.





# The Armor Lieutenant and the M1A2

by First Lieutenant Robert S. Krenzel, Jr.

A great deal has been said and written recently about the Inter-vehicular Information System, or IVIS, and the M1A2. The discussion has focused on the employment of IVIS at the task force level. The purpose of this article is to discuss the M1A2, within the context of a few of the Battlefield Operating Systems, as it relates to the Armor lieutenant—both as tank platoon leader and as tank company executive officer. The M1A2 opens up a great many possibilities for an Armor lieutenant, but it also presents a number of challenges. Hopefully, this article will provide food for thought, both for the platoon leaders and XO's who will ride the M1A2 into the 21st Century and for those who must train them.

It is not my intent to discuss the technical details of the M1A2; this has been done comprehensively in the past year.<sup>1</sup> But I do intend to discuss the way the M1A2 can be used to improve the way we fight, focusing primarily on the ways the M1A2 affects reporting, navigation, fire distribution, and situational awareness. I will also discuss a few of the training issues we must deal with if we are to maximize the effectiveness of the M1A2.

## Command, Control, and Communications

IVIS allows M1A2 tanks to send digital messages to one another according to a strict hierarchy. This traffic includes such things as current position, overlays, and a variety of reports, which are displayed on the Commander's Integrated Display (CID). Currently, this digital traffic is transmitted on the unit's conventional voice radio net, and competes with voice traffic. Perhaps the most difficult aspect of using IVIS is establishing an SOP governing who sends what IVIS traffic when. This is not necessarily a major concern during preparation for combat, when traffic is light and not always urgent, but during combat, IVIS training and discipline are critical to ensure that important information reaches those who need it the most.

Doctrinally, the XO is the company battle captain — he manages the task force net while the commander fights on the company net. IVIS traffic on the company net can be minimized if the company XO is proficient at maneuvering his tank into a covered and concealed position where he can observe

(and lose to) the enemy, and then use IVIS to report higher. The XO must strike a fine balance between observing, reporting, and fighting, almost holding his tank in a sort of company reserve until the initial reporting requirements are met. The XO needs to find a position or positions — usually maneuvering around the support element in the offense — from which he can see and assess what is happening, report higher, and influence the fight when he does join in. If successful, the XO will not require many digital reports from the platoons. He will generate and send them himself, freeing the commander to fight the company, and the platoon leaders and platoon sergeants free to fight their platoons and sections.

When the company makes contact, if the XO can lose to the enemy, generate and send a contact report, he should simply announce on the company net that he has acquired the enemy (thus notifying the platoons that reports are not needed). He loses, producing an eight-digit grid to the position, and transmits the grid in his IVIS report. The M1A2's ability to use its laser to generate an accurate grid is known as

“far-target designate.” In restrictive terrain, the XO probably won’t be able to do this, so he must quickly consolidate reports from his platoon sergeants (or platoon leaders, if their platoon sergeants are too heavily engaged) and paint a digital picture of the battlefield for the commander. Whether consolidating or generating reports, the XO’s display shows him the enemy’s locations relative to both the maneuver graphics and friendly forces. This increased situational awareness allows the XO to assist the commander in analyzing and developing the situation.

It should be pointed out that it is not necessary for the XO to send higher the position to every enemy vehicle. For example, a rough center-of-mass grid for each enemy platoon position should suffice for the task force commander to get a grasp of the shape of an enemy company’s battle position. Too many reports will clutter up the task force nets and CID screens, keep the XO too busy pushing buttons, and overwhelm all concerned with redundant data. The XO must quickly and accurately identify what information is critical, send it digitally to the task force, and then get into the fight.

## Maneuver

To use IVIS as discussed, company leaders need to be able to spend some time inside the turret operating the CID and the Commander’s Independent Thermal Viewer, or CITV. In his article, “Achieving Digital Destruction: Challenges for the M1A2 Task Force,” Major Dean A. Nowowiejski suggested that leaders at the task force level (TF commander and S3) tend to become “glued” to their CID screens, paying too little attention to their own tanks and their immediate surroundings. It is the author’s experience, however, that platoon-level leaders pay too *little* attention to their CITVs and CIDs. They prefer to be “out of the hatch” where they can get a better panoramic view of their surroundings. In the offense, they usually only drop down to use the CID for navigation. Aside from the fact that insistence upon this technique can be hazardous to one’s health, it fails to take full advantage of the M1A2’s capabilities.<sup>2</sup> Our lieutenants must learn when to ride in and when to ride out of the hatch. Commanding from out of the hatch is a necessary skill; often it is the

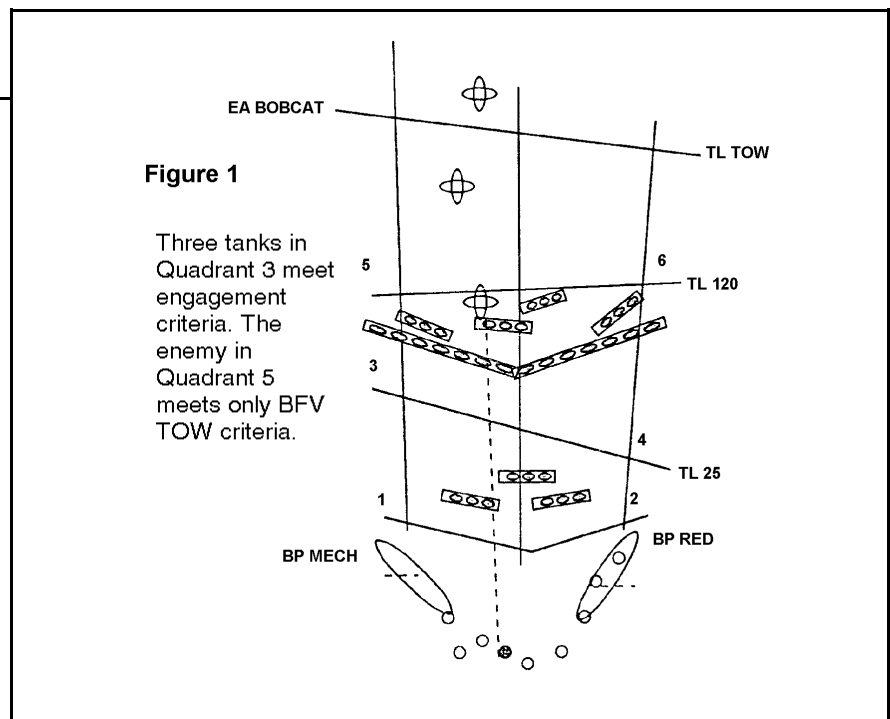

only safe way for a TC to maneuver his tank. Commanding from inside is much harder, but is an equally important skill. The lieutenant may be forced inside by small arms, artillery, NBC conditions, or simply the need to use IVIS or the CITV. Only training and discipline can teach the proper balance and expand our lieutenants’ abilities and effectiveness.

With our new-found ability to quickly and accurately report enemy locations, we should make some refinements to our actions on contact. According to doctrine, we return fire on contact, seek cover and concealment, and develop the situation. If we modify our development of the situation to include realistic standards for digital reporting, we can revolutionize our way of fighting.

As discussed, the company battle captain, the XO, must report the situation higher. While he is turning perception into bits of data, the commander and platoon leaders must be controlling and distributing fires and starting movement. If the commander is proficient with IVIS, he can use his fire support overlay to quickly draw a fire distribution quadrant or designate TRPs.<sup>3</sup> He sends these down, platoon leaders add their own control measures (if necessary), and relay the overlays to their platoons. Each tank now has a common frame of reference. The gunner lases and the TC glances quickly at his CID. If the threat icon produced by lasing is in the appropriate quadrant or

near the proper TRP, “FIRE!” (see Figure 1)

This all sounds wonderful, but again, achieving the level of proficiency described will be difficult. It will require extensive training, complicated by the fact that you can’t practice lasing just anywhere. Without an eye-safe filter for the LRF that still allows some range return (which the current ESLR device does *not* do), or an eye-safe LRF to begin with, such training will only be possible on gunnery ranges. The M1A2 does have a choke sight in the CITV, which allows the TC to adjust a reticle-like box to the size of the target, thus approximating the range. The choke sight could help somewhat in filling the current LRF gap, but it is much slower and requires a T-72/T-80-size target. It would not be possible to practice reporting the locations of non-vehicular targets. Effective Intelligence Preparation of the Battlefield (IPB) can help anticipate where to place TRPs or quadrants, but to use the system “on the fly” the lieutenant or captain must be technically competent to the extreme. Creative solutions are needed to overcome the challenge of training to integrate the total tank system.

During combat, the role of each tank ought to dictate how each TC uses his system. For example, in the offense, overwatching TCs should be mostly inside their turrets. Since the overwatch element is supposed to suppress the enemy and draw fire, being inside the hatch will protect the overwatch TCs

*"The skills required of an Armor lieutenant, and the demands placed upon him, increase with the advent of the M1A2. Tank commanders, especially platoon sergeants and up, need more experience with computers and their workings to effectively employ their tanks. The Armor officer, especially the tank company XO, must practice until he is the absolute master of the system under his control..."*

from the fires they ought to be drawing. Furthermore, the overwatch TCs should use their CITYVs to scan for and designate targets, and their CIDs to monitor the enemy and friendly situations. Each TC must be aware of where he is firing in relation to friendly and enemy forces. Fratricide can be reduced if TCs monitor friendly movements and verify targets or shift fire when friendly units enter their sectors of fire. If the "enemy" icon produced by lasing (usually accurate to within fifty meters if the LRF and Position Navigation System are functioning properly) coincides with the location of one or more "friendly" icons, the gunner has probably lased to a friendly position and firing may result in fratricide.

The bounding element can employ the navigational advantages of the M1A2's Position Navigation System (POSNAV) to quickly and safely make its movement. The TC can monitor his progress relative to friendly and enemy elements he could not otherwise see. POSNAV can be of great help in passage of lines or finding an obstacle breach site. For example, if an engineer with a GPS or an M1A2 plow tank can get an accurate eight-digit grid to the entrance to a breach, and that grid can be disseminated through voice or digital means, the M1A2's "steer-to" feature allows another TC to enter that grid as a "Critical Point." A Critical Point can be designated a navigational waypoint, to which the tank will direct the driver by means of a direction and distance shown on the Driver's Integrated Display. In this case, the bounding platoon leader is free to be out of the hatch, better able to maneuver his tank and platoon. Once a well-maintained and prepared tank and terrain-smart driver are told where they are going, they will get the platoon leader precisely where he wants to go with minimal guidance.<sup>4</sup>

The M1A2's advantages could be even more pronounced in a Lesser Regional Contingency (LRC), where independent operations of company, platoon, or even section size might be common.<sup>5</sup> For example, if a platoon operating independently were ambushed, it might fight through to a covered and concealed position from

which the platoon sergeant could report digitally to the company headquarters. With a smaller threat array and presumably less urgent radio traffic than encountered in a high-intensity conflict, these reports could be detailed and highly accurate. The company or task force commander would use these reports to focus far-flung resources to aid the embattled platoon. With the M1A2's improved situational awareness, combat multipliers — such as artillery and close air support — could be focused much more accurately and with reduced risk of fratricide. Even if combat multipliers were not available, a series of spot reports showing enemy locations would allow multiple M1A2 units to converge, relatively certain of friendly and enemy positions.

### **Combat Service Support**

Unfortunately, the current availability of IVIS does not lend itself easily to integration with the other arms. The kind of integration that would be of most help to the M1A2 company team, aside from IVIS-equipped FISTVs and BFVs, would be the digitization of the company combat trains. If someone in the trains had dual net, IVIS, and POSNAV capabilities (at least the first sergeant, but preferably also the medics and mechanics) casualty evacuation and vehicle recovery would be greatly enhanced.

The mechanics would benefit from being able to send vehicle damage reports and parts requests directly to the combat trains command post. The medics could locate casualties and aid stations more easily. The first sergeant could more effectively orchestrate logistics operations with IVIS and POSNAV. He would, at least, be able to find his company, which is not always easy during offensive operations, as any first sergeant with an NTC rotation under his belt can attest.

Currently, these options are not available, but there is hope for the future. The 1st Cavalry Division is preparing to field the Enhanced Position Location Reporting System (EPLRS). Although the final configuration and distribution of EPLRS equipment is not final,

EPLRS may overcome some of the current deficiencies and enhance the logistics reporting process.<sup>6</sup>

### **Future Battle**

The skills required of an Armor lieutenant, and the demands placed upon him, increase with the advent of the M1A2. Tank commanders, especially platoon sergeants and up, need more experience with computers and their workings to effectively employ their tanks. The Armor officer, especially the tank company XO, must practice until he is the absolute master of the system under his control. He must know not only the maintenance aspects of the M1A2 (much different from the M1A1), but also the use of the CITYV and IVIS. In the future, leaders at all levels must become more proficient at not only reporting, but at assessing the situation, the importance of what they want to report, and the best way to report it.

This summer, the 3rd Battalion, 8th Cavalry Regiment, 1st Cavalry Division, will be the first U.S. Armor battalion to field the M1A2. If it is successful in meeting the challenges described above, then a future encounter between TF 3-8 CAV and some enemy might look something like this:

**15 1700 April 96**

**AA DRAGON**

**D/3-8 CAV CP**

The task force warning order had been issued only four-and-a-half hours ago: Hasty attack at 16 0600 April — tomorrow morning. The companies received the IVIS graphics digitally at about 1630 hours. The Delta team commander and FSO were at the TOC receiving the OPORD while their company prepared, rehearsed, and inspected. In the meeting engagement yesterday, TF 3-8 had been held in division reserve while the 1st CAV pushed the enemy back onto the defensive. It looked like breaking the enemy's defense was next on the agenda, only this time 3-8 would be out front.

**Figure 2**

**Enemy Defense and Friendly Fire Control Measures**

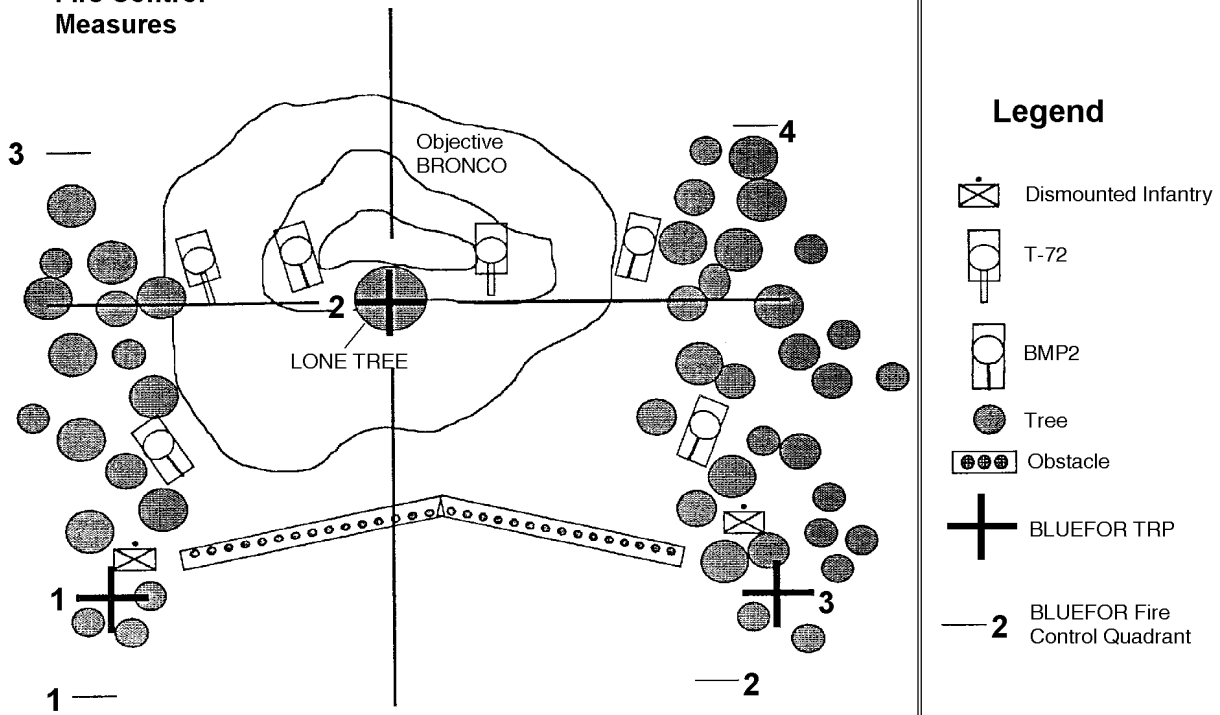

TF 3-8 CAV was attacking to destroy an enemy motor rifle company set up in linear defense. D/3-8 CAV, Team Dragon, consisting of the company headquarters, two M1A2 platoons, one M2A2 BFV infantry platoon, and a combat engineer platoon, had the mission of fixing — and if possible destroying — a reinforced motor rifle platoon (MRP) south of the task force main effort. The mechanized infantry teams, C/1-9 and D/2-7, were to destroy the two MRPs in the north. A/3-8 CAV, an armor team, was in task force reserve.

When the XO spotted his commander's HMMWV returning, he notified the platoon leaders, the commander's tank crew, and the CP track to prepare to receive a warning order and to go on a leaders' recon. The commander arrived, the WARNORD was issued, the platoon leaders briefed their tank commanders, and the company orders group moved out within 45 minutes.

The commander used his map, POSNAV, and the IVIS graphics to guide him forward to a small knob just short of the LD, from which he could make out tomorrow's objective in the dis-

tance. OBJ BRONCO was a fairly small hill with wooded low ground on the right, left, and far sides. A prominent lone tree stood just on the near side of the hill's crest. The commander recognized the tree's usefulness and told his lieutenants, "That tree is TRP 2, the center of the quadrant." Using their maps and their view of the objective, the recon party established a quadrant method fire control plan (see Figure 2). They could see no obstacles, but their IPB led them to believe obstacles would be emplaced in the low ground in front of the objective, with the flanks of the obstacle protected by dismounts in the woodlines. The recon party discussed actions on the objective and worked back through the planned mission, identifying control measures and routes. The attack position was reconnoitered, and the routes from the AA to the LD were reconned and timed. Key points were entered as IVIS critical points.

With the recon complete, the CO and XO settled in to write the OPORD while the platoons rehearsed, bore-sighted, and conducted pre-combat inspections. Because of time constraints the order was simple, relying heavily on rehearsals and oft-practiced drills

and SOPs to fill in the gaps. Once the order was ready, the CO, XO, and FSO took a few minutes to edit the digital operations and fire support overlays, adding waypoints, targets, and the fire control scheme. The OPORD was issued and the mission was walked-through and rehearsed several times. Included were digital rehearsals, which stressed reporting and the use of the CID, CITV, and POSNAV. It was late before everyone was satisfied.

**16 0600 APRIL 1996  
LD/LC ALONG AXIS HAMMER**

Stand-to and movement to the LD had been uneventful. The S2's "intel dump" at stand-to, accompanied by an updated digital enemy overlay, confirmed some of the previous day's IPB, especially concerning the presence of dismounts and obstacles. The scouts had reported a mine-wire obstacle being emplaced in front of BRONCO, but enemy patrol activity had prevented the acquisition of precise locations.

Team Dragon crossed the LD in a company wedge (see Figure 3). Although the two mechanized teams to the north had no IVIS, the task force

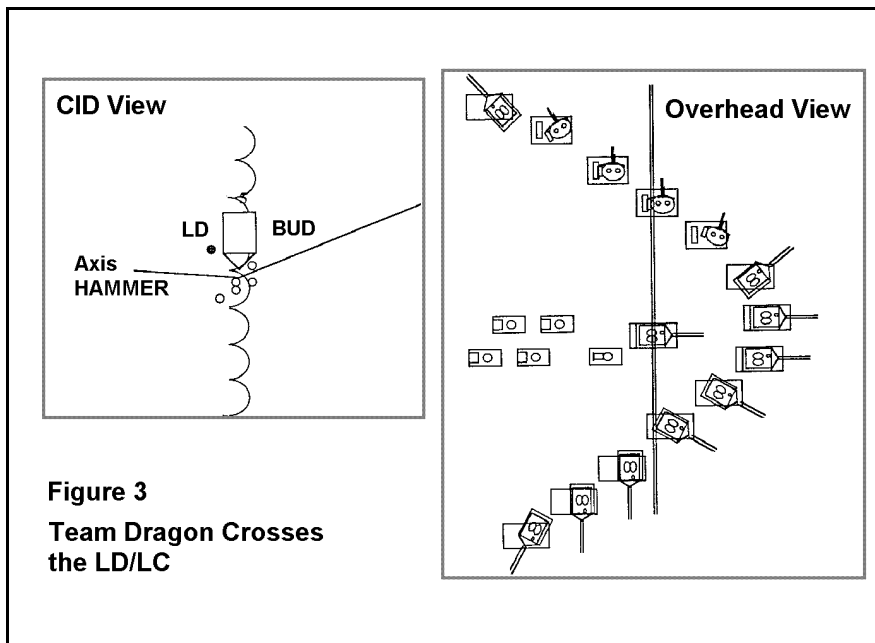

**Figure 3**  
Team Dragon Crosses the LD/LC

commander and S3 were each moving with one of these teams, allowing Team Dragon to monitor its neighbors' progress, adjusting its own speed to keep in sync.

About two kilometers past the LD the morning calm was shattered by a burst of 25-mm fire. "Dragon 6, this is Green 4 — Contact, BMP north, out!" The infantry platoon sergeant had identified a BMP2, probably a combat outpost vehicle, hiding about 800m to his north. He was engaging it, as was his platoon leader.

"Identify PC!" shouted D-50's gunner. His TC, the XO, responded, "They've got him, hold your fire, but

give me a lase and look for his friends." Before the BMP could return effective fire, the Bradleys found the range and were pounding it with 25-mm AP. D-50 lased to the dying BMP, producing a grid for the digital contact report the XO punched in. (Out of habit, he had already called up the contact report menu on his CID prior to crossing the LD). The enemy icon was well away from the nearest TF 3-8 Scout OP, which reassured the XO. "Mustang 6, Dragon 5, engaged and destroyed one BMP, we are still at 10 and 4, check mailbox." The XO pressed "SEND" and "CONFIRM," and in seconds the task force commander was looking at an icon marking the 8-digit

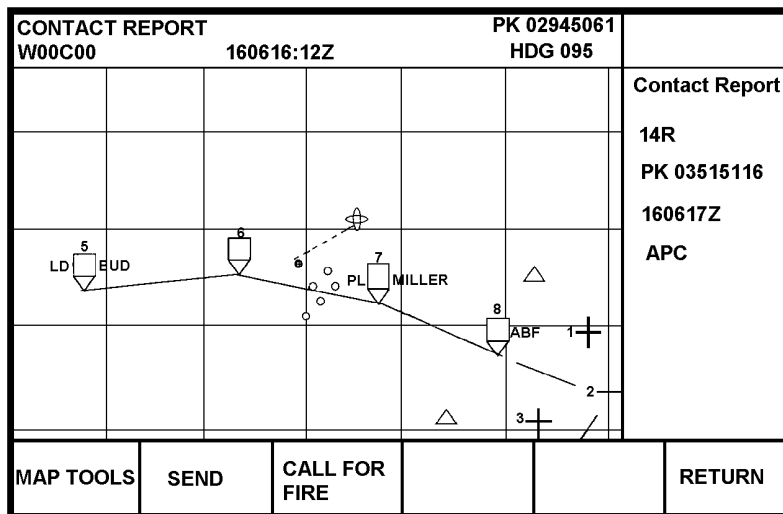

**Figure 4**  
"...Engaged and destroyed one BMP..."

grid of the dead BMP—a part of the enemy security zone (see Figure 4).

"First blood to the Brads — everybody stay sharp, that guy probably reported our arrival," cautioned Dragon 6.

"Identify troops ' behind the BMP!" called the XO's gunner. "Fire and adjust," replied the XO. D-50 fired a long burst of coax; the XO let both company and task force nets know he was engaging troops at the same grid as his last contact. Cross-talk on the company net kept the engineers and company trains out of RPG range of the dismounts, and Team Dragon continued to move. Two more OPs were destroyed by the teams to the north. The various reports showed an enemy security zone 2500 to 3500 meters in front of the expected enemy battle positions.

In the low ground just short of the Attack-by-Fire Position (ABF), Team Dragon came on line. The infantry platoon was on the left, 1st Platoon in the center, and 2nd on the right. D-50 was to the left and D-60 to the right of 1st Platoon. The team came to turret defilade in unison, careful not to expose themselves to enemy fire.

By SOP, the team took one minute to scan and assess the enemy situation. Two tanks per platoon scanned with GPS and binoculars, the rest used TIS and CITVs. The XO could identify one T-72 and three BMP2s in turret defilade, and could make out the center, but not the flanks, of the obstacle. He announced on the net, "Dragons, Dragon 5, I've got the enemy, but I need both ends of the obstacle." The tank platoons were able to provide him with the information (see Figure 5). The XO sent two spot reports outlining the enemy position, posted the obstacle reports, and used them to draw the enemy obstacle on his obstacle overlay. He also sent this to higher. (Having much practice, this whole process took the XO about thirty seconds.) By this time, the commander had verified the previous fire control plan, had the FSO calling for mortar smoke, and was discussing a possible breach with the engineer. A burst of the engineer platoon leader's .50 cal. marked the chosen breach site. Then Team Dragon rose to hull defilade — the fight was on.

As rehearsed, the BFVs fired the close-in quadrants and the tanks engaged farther out. The enemy was stronger than expected: two T-72s and

four BMP2s, plus about 25 dismounts between the two flank positions. In spite of the unusually large threat, the Americans' superior personnel, equipment, training, and fire distribution enabled them to gain the upper hand. The enemy scored a few near-misses, and one of 1st Platoon's tanks was suffering TEU and FCEU faults after a non-penetrating hit, but the damage inflicted by Team Dragon was far worse. After only a few minutes, all four BMPs were burning, and one of the T-72s had exploded, leaving only one tank and most of the dismounts.

The mortar smoke, after some adjustment, was building up between the remaining T-72 and the breach site. (To compensate for the smoke's effects on their lasers, the Dragon tanks had entered their average range to the T-72's position, about 1800m, as their battlesight range.) The conditions were right for a breach.

"Guidons, this is Dragon 6...Battle-carry HEAT (SOP to protect dismounted sappers from sabot petals). Green suppress quad 1. Red, engage quads 3 and 4. White, secure breach site and suppress quad 2. Sapper, White, prepare to breach. Acknowledge."

As the platoons acknowledged, the XO reported higher, "Mustang 6, this is Dragon 5. Engaged and destroyed one tank, four BMPs. Engaging one tank and two squad-sized elements. We are initiating a breach to our south, over."

Shortly afterward, the 2nd platoon had established a position from which it could observe the entire obstacle and engage the dismounts on the southern flank. "Dragon 6, White 1 — breach secure!"

"This is Dragon 6. Roger. Sapper: breach NOW!"

The engineer platoon moved out rapidly. The engineer MICLICs were to open the two lanes, which would be proofed by dismounts. 2nd Platoon's plow tank was the reserve. When the time came to launch, one of the MICLICs failed, so the plow tank moved into position and dropped its blade. Once the operational MICLIC was detonated and the plow tank got through, the sapper squads started to proof the lanes.

On D-50 the gunner scanned the obstacle, looking for dismounts in the ob-

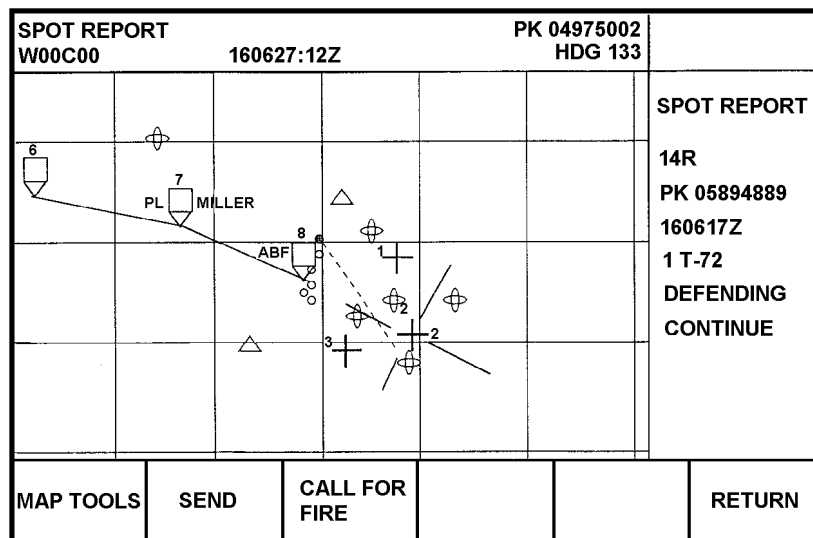

Figure 5. "Engaging one tank, three BMPs, check mail box..."

stacle itself (a trick he had learned at the NTC) while his TC used the CITY to scan the enemy battle position and monitor the progress of the breach. When the last T-72 finally worked up the courage to start slowly moving up for a shot at the engineers, the XO spotted him with the CITY.

"Gunner, Battlesight, Designate Tank — Driver move out!" A press of a button on the Commander's Control Handle Assembly (CCHA) slewed the turret and laid the gunner onto the T-72 as D-50 surged forward. The crew of the T-72 was not fast enough; two HEAT rounds in rapid succession sealed their fate.

A few minutes after this last T-72's turret blew off, the engineer platoon

leader reported the GPS-obtained grids to the entrances to the two lanes, both of which were nearing completion. The XO entered these grids as critical points on his obstacle overlay. The tank platoon sergeants entered them on their operations overlays, so they could use them as waypoints, and relayed them digitally to their platoons.<sup>8</sup>

"Dragon 6, Sapper 1. Right lane clear."

"White moving!" announced the 2nd platoon leader, knowing the next step was for him to secure the far side. A few minutes later, "Far side secure."

"Dragon 6, Sapper 1. Left lane clear."

"Green, Dragon 6, assault and clear enemy vicinity TRP 3. White shift to

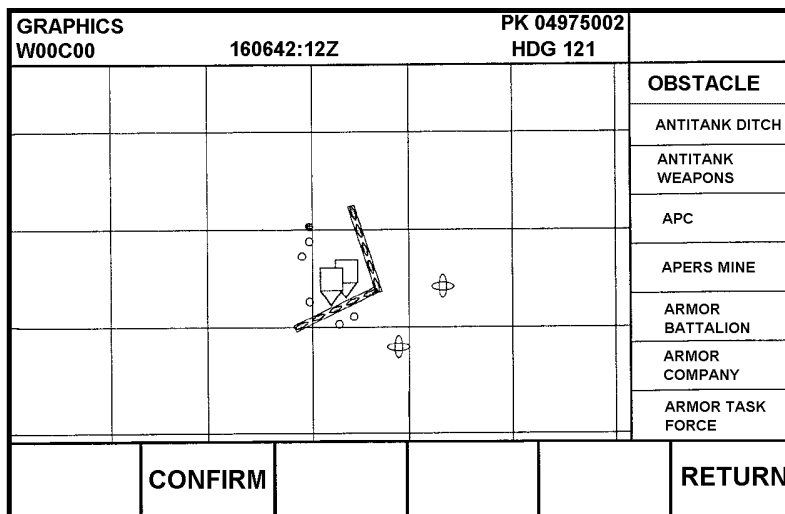

Figure 6. "...Breaches open..."

quad 3 and 4. Red shift to quad 1. FIST, lift your smoke. Acknowledge.” The XO reported higher that the lanes were open and sent his overlay (see Figure 6).

Within a few seconds the infantry platoon was moving behind 1st platoon and heading through the breach. They dismounted their squads and started working into the woodline. At the CO’s command, as rehearsed, one 2nd platoon wing tank came up on the company net, which the dismounts were operating on, and became OPCON to the dismount squad.<sup>9</sup>

Once the infantry had a clear upper hand in the dismount fight, the CO ordered 2nd Platoon and a Bradley section to move onto the objective. He accompanied them. 1st platoon used CID screens to track the assaulting elements. As soon as he was set on the objective, the CO called 1st platoon forward; the FSO called for mortar fire to continue the suppression on the left flank.

“Mustang 6, this is Dragon 6. I am set on Bronco and consolidating.”

Mustang 6 acknowledged and ordered the reserve to move through Team Dragon and roll up the enemy from the south. Alpha Team, guided by POS-NAV and the critical points sent on Dragon’s obstacle overlay, moved out toward the breach at OBJ BRONCO.

Meanwhile, as Delta Team’s 2nd platoon leader was repositioning on the objective, his tank was rocked by an explosion as an AT-5 missile slammed into his left track. Within seconds, two more missiles narrowly missed other Dragon tanks.

“Dragon 6, White 4, Contact-Sagger-Northeast, out!”

The enemy anti-tank reserve, three BRDM/AT-5s, had engaged. A few tanks and the BFVs had spotted the missiles’ launch and were returning fire.

“Dragons, Dragon 5. I cannot identify — give me a report.”

“This is Red 4. Stand by...check mailbox.”

The net crackled and the incoming message box on D-50’s CID filled with news of Red 4’s contact report. The XO verified the enemy’s location. The fire support overlay showed the enemy

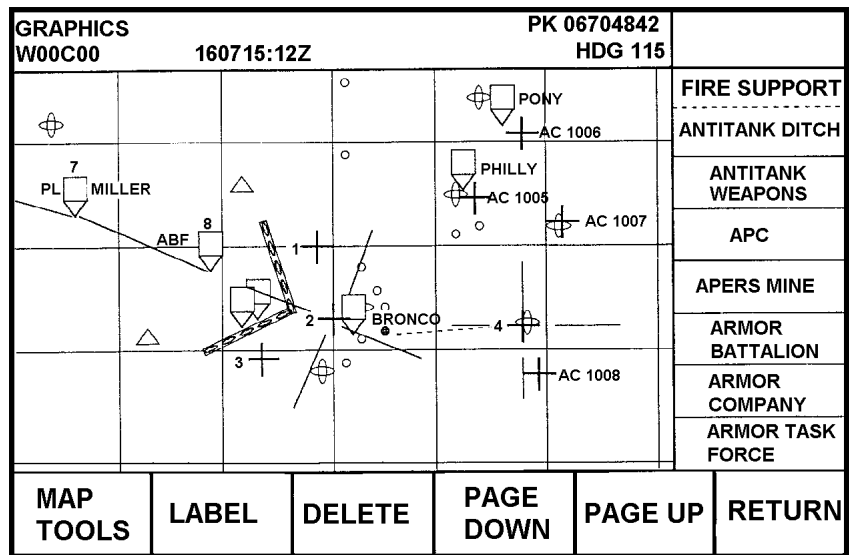

Figure 7. The reserve completes the enemy’s destruction.

icon to coincide with a planned artillery target, AC1007.

“Mustang 6, this is Dragon 5. Engaging three Sagger vicinity AC 1007. Request fires. Check mailbox”

The task force commander studied this report from Dragon 5. He and the S2 had suspected the AT reserve might be on that hill. AC 1007 was perfect — he ordered it fired with DPICM.

Just then, one of 2nd platoon’s tanks spotted another threat, a T-72 of the Combined Arms Reserve (CAR) nosing out of some low ground to the east. The 2nd platoon TC engaged and reported, and his platoon sergeant relayed. Within a few seconds the T-72 was destroyed.

“Green 1, Dragon 6, suppress ATGMs at AC 1007. White, Red, the burning tank is TRP 8, center of the quadrant. Red, you take quads 1 and 3; White has 2 and 4. Check mailbox.” The CO sent his hastily drawn fire distribution plan.

“Mustang 6, Dragon 5. Engaging one tank, three BMPs. Tank destroyed. Check mailbox.”

The task force S2 came on the net and estimated that the enemy battalion had committed its entire reserve against the Dragons. The Dragon fire distribution plan had been rushed, but was effective enough to prove lethal for two of the three BMPs trying to come on line to return fire. When artillery started falling on the ATGM platoon to his north, and both of his other BMPs were destroyed, the CAR motor rifle

platoon leader decided to run for it. As he fired his smoke grenades and broke contact, secondary explosions and pillars of smoke could be seen where the ATGM fire had originated.

“Mustang 6, Dragon 5. Destroyed two BMPs; one BMP appears to be withdrawing to the east. At least two Sagger destroyed.” As he reported this, the XO could see on his CID that the dismounts were near TRP 1: the position of the northern set of enemy dismounts. He could also see Alpha Team’s icons approaching the breaches.

As the firing around OBJ BRONCO died down, the lead tanks of Alpha Team thundered by and turned north. The XO started collecting reports, cross-leveling ammunition, and monitoring casualty evacuation and battle damage repair. All the while he watched the icons of Alpha Team move up to and across OBJs PHILLY and PONY (see Figure 7). He started hearing reports of enemy troops surrendering and abandoning undamaged tanks in their fighting positions. Then came the word from higher:

“Guidons, this is Mustang 6. The brigade reserve is being committed in our sector. Continue consolidation and reorganization; be prepared to continue the attack.”

## Notes

<sup>1</sup>For an excellent description of the M1A2, its capabilities, and its limitations (as they existed during the summer of 1993), see “Achieving

# Driver's Seat

(Continued from Page 5)

Digital Destruction: Challenges for the M1A2 Task Force," by Major Dean A. Nowowiejski in the January-February 1995 issue of *ARMOR*. Major Nowowiejski was the battalion S3 for 3-8 Cavalry throughout the M1A2 NETT, gunnery, NTC train-up, and NTC Rotation 93-10. During this time, I was an M1A2 platoon leader in A/3-8 CAV. Major Nowowiejski's article provided the inspiration for this article.

<sup>2</sup>For an interesting treatment of the hazards of fighting "out of the hatch," especially in a LRC, see *Tank Sergeant* by Ralph Zumbro.

<sup>3</sup>For a detailed discussion of these techniques, see "Direct Fire Planning, Parts I&II" by MAJ Derek Miller and CPT Rick Avena in the Nov-Dec 1993 and Jan-Feb 1994 issues of *ARMOR*.

<sup>4</sup>In very poor visibility or extreme darkness, when PVS-7Bs and driver's nightsights are of little use, the M1A2's TC can use the CITV to observe the ground to the front of the tank and help guide the driver. The gunner is still free to scan. This technique has obvious disadvantages and limitations. It would be far better if the M1A2 were equipped with the Driver's Thermal Viewer as it was designed to operate.

<sup>5</sup>See "Independent Operations," by Ralph Zumbro, in the Sep-Oct 1993 issue of *ARMOR*.

<sup>6</sup>With the pace of miniaturization, "ruggedization," and CD-ROM technology, is it too much of a stretch of the imagination to hope for an IVIS-like system tied to a CD-ROM drive and printer in the first sergeant's HMMWV and M113, the medic M113, and the maintenance team's M88 and M113? The mechanics could have all the troubleshooting and parts manuals they could hope for, not to mention vehicle histories and ULLS data, right at their fingertips. If they needed a page or two from one of these manuals, they could print them. The medics could maintain manuals and even copies of the company's medical records. The first sergeant could maintain an ARCIS-type data base. Personnel records, ULLS S-4, deployment packets, digital logistics status reports, blank forms, and FMs and TMs — in other words, an effective field version of the garrison training room — could all be maintained forward with the company. Legal, personnel, and logistical functions could be carried out as efficiently in the field as in garrison. The practical applications would be limitless.

<sup>7</sup>"Check mailbox" is IVIS slang to indicate that a message is being sent. It refers to the incoming message box in the upper right-hand corner of the CID screen, which alerts the TC to incoming messages.

<sup>8</sup>The obstacle overlay cannot be used for waypoint navigation, but when transmitted, it goes up and down the chain of command. (The operations overlay only goes down.) If needed for navigation, the operations overlay can be superimposed on the obstacle overlay and the critical points quickly entered.

<sup>9</sup>By logging off his platoon net and logging onto the company net as the "4th Platoon Ser-

geant," the infantry support tank appears on the CID screens on not only his parent PL and PSG tanks, but also on the CO and XO's. This technique not only allows the commander tighter control of his dismounts, but also lets him see them, or at least the tank accompanying them, on his CID. (The technique of operating IVIS and non-IVIS equipped units in close proximity to help maintain track of the non-IVIS unit's position is known as "tethering.") The other obvious advantage is that the dismounts now have a tank in direct support. If the commander is confident enough of success that he is willing to take a tank away from the heavy fight and give it up to his dismounts, as in the case of this vignette, the effectiveness of the dismounts will increase, and their casualties will decrease. Changing nets and chains of command in the midst of a fight can be tricky, but with practice, might be worth the effort.

While tying tanks to dismounted infantry has sometimes proven disastrous in past wars (i.e., France in 1940), this was because whole tank formations were spread out across vast frontages instead of being concentrated. The technique described in this article is a tactical technique, not an organizational, operational, or strategic doctrine. It is used when massed armor is not the most effective or efficient solution. The use of an M1A2 as a dismounted unit's "big brother" effectively uses our latest armored technology to accomplish the original mission of the tank: the destruction of entrenched infantry and machineguns.

First Lieutenant Robert Krenzel was commissioned as a Reserve Armor officer after graduating from Rutgers University in May 1991. His military education includes AOBC, SPLC, and the Airborne Course. He was assigned to 3-8 CAV (then 1-67 Armor) in May 1992, and since then has served as a M1A1 and M1A2 platoon leader and tank company executive officer. He is currently the executive officer of HHC, 3-8 CAV.

The author wishes to thank LTC James H. Nunn, MAJ Michael W. Feil, MAJ John C. Paulson, 1LT(P) Jacob A. Rose, and 1LT(P) Thomas W. Cook for their help, advice, and input during the preparation of this article.

(UCOFT) management skills to ensure students can get their platoons to make adequate progression through the matrix and be able to identify potential problem areas. The student also spends considerable time in the Platoon Gunnery Trainer simulator (PGT).

Being able to operate weapons systems is important, but equally important is maintaining them. The maintenance portion of the course trains those skills necessary for the new platoon sergeant to supervise proper maintenance techniques and procedures, including introduction to the computerized Unit Level Logistics System (ULLS). The student's understanding of ULLS enables him to track the status of his equipment's repair progress and required service schedules, and adequately plan for training events based on equipment readiness. Knowing how to operate and maintain the unit's equipment is important, but he must also know how to employ it.

Tactical training is the meat of the course. Doctrinal training in this area includes all aspects of platoon maneuver, tactical road marches, actions on contact; offensive and defensive operations, and passage of lines, just to name a few. Additionally, the scout portion of the course stresses reconnaissance, information gathering, and reporting techniques when conducting mounted and dismounted patrolling missions.

Our new potential platoon sergeants will be attending a course that is both extremely challenging and demanding. When they come to you, you can be sure they will have the warfighting confidence and ability to be successful. They will be an important part of your unit and the armor force as a whole, no matter where an assignment takes them. Indeed, they will also have the knowledge of what it takes to care for their troops and families.

The Armor Center is at the forefront in ensuring our leaders are prepared to make that leap into the twenty-first century and our NCO Academy's Advance Course is the "Hook Up and Shuffle to the Door" point. All that remains is for you, the leaders, to give them the opportunity. I challenge you to put them to the test.



# LETTERS (Continued from Page 3)

An example of this is when my troop conducted BCPC. As the troop Bradley master gunner, my intent was to use an actual range to better familiarize the new Bradley crews.

This also was the thinking of the tank master gunner and, because of limited range time, both tanks and Bradleys conducted TCPC/BCPC simultaneously. By running tanks down one lane, and simultaneously running Bradley's down another, we were able to maximize our range time and further build cohesion between the two elements.

I feel the success of this BCPC/TCPC was due to the tank and Bradley master gunner's willingness to become familiar with each other's equipment and gunnery standards, allowing both to take turns running the range.

As a 19D firing table X, you are evaluated on your ability to call for and adjust fire, yet on the battlefield you will also have to talk helicopters and tanks onto targets, mark targets with direct and indirect fire, and/or assist in massing fires on them. Should the master gunner be the technical and tactical expert in such a combined arms engagement? By all means, yes; thus the importance of his coordination skills, teamwork with his fellow tank master gunners, and the absolute must of understanding all the equipment on the battlefield.

This is quite a load to bear as a soldier in the cavalry; this is the reason only the best are selected and pass the challenge of the Master Gunner School.

The combined arms concept has already proven successful against a numerically superior force, and the technology of today's Army makes us the superior on any battlefield. It is up to us to make it work.

RECON OUT FRONT!

SSG FRANK R. BELONUS  
Troop Master Gunner  
B/1-4 Cavalry  
Ft. Riley, Kan.

SFC LEONARD W. FORMOSEA  
Unit Readiness NCO  
B/149 AR

## Change Course Prerequisites

Dear Sir:

Recently, I had the misfortune to attend the Senior Instructor Operator Course at the Armor School. I did not graduate because, although I tried, my 19E skills were not enough and no match for the M1 advanced matrix. Upon arrival at the course, I was informed that, although there is no mention of the fact that the Armor School does accept A1 screen applications from ARNG personnel and screens them, no M60A3 Senior Instructor Operator course exists, even though there are still M60A3TTS tanks in the system, and some

units are not scheduled to transition until 1997.

I spent considerable time getting recertified during my Christmas leave, not to mention that I invested my own funds to attend the course. I was informed that since I was there, I would be allowed to take the entrance examination; however, there was no mention of any required training on the M1A1 Turret system. I passed the entrance exam and went into the course to begin training, and foreseeing a problem, requested and got extra training during the evening. The reason I am writing this letter is that even though I requested extra training, I sensed the attitude of the course manager and those civilian instructors was that because I was an M60A3 (19E) tanker, I was going to hold up the other students.

I would recommend that Fort Knox changes the course prerequisites to include only those ARNG personnel who are NETT-qualified and either drop 19E personnel from the course listing or ensure that M1A1 experience is required in order to take this course.

I wasted considerable training time at Ft. Knox and approximately \$650 out of my own pocket (per diem is not paid for this course), not to mention wasted time away from my AGR position, which at tank company level never gets replacement or augmentation. Funds are short, so we cannot pay someone while the ARNG full-time unit support personnel are not there. If I had known that M1A1 and advanced matrix experience was a requirement, I would have made an effort to train on these subjects.

It would be very helpful to make those suggested changes to the course so that someone else does not make the mistake and/or waste precious training funds or resources and training time in a situation like this.

## Autoloaders — Thanks, But No Thanks

Dear Sir:

In the article submitted by Western Design Corporation, "Ammunition Loading Systems for Future Tanks," much thought is given to clever autoloader designs, but not much thought to the realities of life on a tank. Sharoni and Bacon contend that "any rational design approach for a future main battle tank will commence with the selection of the armament system, to include the main gun and the ALS." Shouldn't it really commence with an understanding of what tankers need to fight and win? I will not bore the reader with the list of duties per-

formed by a loader that cannot be performed by a piece of machinery. Suffice it to say that a tank crew is a team and every man is essential to the success of the mission. Automation of the main gun will not reduce the "workload" of a tank crew or platoon. What an autoloader will do is take up precious space, require maintenance, and almost certainly reduce the number of troops available to accomplish the mission.

Sharoni and Bacon state that "the three-versus-four-man-crew is a doctrinal issue and should not be driven by engineering considerations." Having said that, they move right on to bend doctrine to fit an autoloader design. Here are some doctrinal issues from a line unit.

1. Keep it simple.

2. Tank crews cannot afford to be any smaller; there's too much soldiering to be done.

3. Tank designs that sport unmanned turrets are a no-go. The tanker's greatest asset is his commanding first-person view of the battlefield. The crew needs to be up in the turret, oriented with the weapons. Fighting a tank from the hull like a mole may increase survivability, but strips the crew of its natural situation awareness and ability to fight the tank.

WDC decrees that "automatic loading systems will become standard... Crew member duties will be readjusted to address other battlefield management technological needs." Wow, sounds great. Perhaps they can explain how to "readjust" the tasks required to prepare a defensive position. I'll be all for an autoloader when it can replace the M8 chemical alarms.

Incorporating an autoloader would be great for companies like Western Design, but it wouldn't do companies like Charlie, 3d Tank any good. Let's spend the money on something useful, like the long-overdue Under Armor Auxiliary Power Unit (read: a decent generator for silent watch), or a MK-19 for the loader to use. Autoloaders are wonders of engineering, but I say: thanks, but NO THANKS.

TODD R. BRANNON  
1LT, Armor  
C/3-112 Armor, TXARNG

## Improving Leadership Training

Dear Sir:

*"To command is to serve, nothing more, nothing less." — Andre Malreaux*

I concur with much of the argument made by CPT Kenneth H. Webb in his March-April letter "The Combat Arms Leader." In this time of rapid technological change, specialization is maladaptive. The pace of change is increasing at such a rate that to-

day's specialists will, in all likelihood, become the obsolete and out of touch work force of tomorrow. I agree that it is becoming increasingly important for our officers to learn how to synchronize battlefield operating systems at the company grade level; in the division cavalry, our lieutenants are frequently placed in a position where they must coordinate the direct and indirect fires and army aviation assets organic to our squadrons. It simply is not necessary, nor is it desirable, for every officer to become an expert in each of the weapons systems and CSS systems at his disposal in order to be an effective commander. Our Warrant Officer and Noncommissioned Officer Corps are more than capable of providing us with the expert guidance and technical support we need to get any job done.

As we grow smaller, we must grow better. How we grow better is what we seem to be struggling with now. I stoutly disagree with the proposition put forth by MAJ Morrison, September-October 1994 "Armor Officer 2000," that our "second-stringers" be farmed out to ROTC command and CSS jobs. If training is the most important job we have in peacetime, then training our future leaders should be a task reserved for our finest, not second-best. No branch of our Army can afford to tolerate captains or colonels who are not fully qualified to compete with others for command of any unit, tactical or otherwise. Our present system of schools certainly can be improved, but not by staffing them with the outcasts of our mainstream professional culture. MAJ Morrison is right on target, however, in his assessment of CAS<sup>3</sup>. By the time most of us get there, we've already done the jobs it prepares us for, and under much more stressful conditions. The basics are already covered in our Advanced Course. Perhaps what we need is a post command, preutilization tour of a week or so, or AAR and brainstorming session to capture some of what we've learned at the company level for future generations.

I also disagree with the "credentialing" path that MAJ Morrison lays out. Airborne, Ranger, and Air Assault Schools have their place, to be sure, but they do not necessarily provide us with better leaders. Leaders provide us with better leaders. Officers that make the time to spend with their junior leaders and teach them, mentor them, or just plain kick 'em in the butt and get them moving in the right direction are our most reliable source of leader development and leader selection. If we are going to require our officers to graduate from some sort of leadership school, let's make one of our own at the Armor School. Let's make it part of the Basic Course and give everyone a chance to attend. In fact, throw in our junior NCO leadership as well, and make this a follow-on for PLDC or BNCO and really round out the student population. Let's make it as tough as Ranger School so we don't feel like second-class citizens when we hang out with infantry guys, but make it into something armor officers can

really benefit from. The Scout Platoon Leader Course is a great beginning and meets the standard of toughness we need. Doing 19D and 19K tasks for five or six weeks non-stop in the woods around Ft. Knox, with a week or so in the desert at Ft. Irwin, would be great stuff and immediately relevant to our branch. It would provide us with leadership training that is grounded in armor/cavalry tactical doctrine. Let's even award a badge or tab to top it off!

So much is changing, and so fast. If we are going to change our professional development or career management system, let's do it with a clear head and clear objectives. It's easy to become fascinated with all the new technology we have at our disposal, but let's learn how to use it effectively and see what it can and can't do for us before we leap to any conclusions regarding its effect on our future. Good examples of how not to implement new technologies abound in business, sociological, anthropological, and historical literature. We need to get better at learning from these examples and looking at how we use emerging technologies to our maximum advantage. Let's not become so enthralled with technology that we forget what it is we are about, and what it is that we want to become.

Finally, when it comes to deciding who is best qualified to lead or command, the best tool we have at our disposal is the officer evaluation system. It may require some tweaking, but the basic framework is in place. I believe that the best measure of the man is and will remain an involved and dedicated senior officer; an officer who is involved in the development of his subordinates and dedicated to the future robustness of his officer corps. No amount of schooling can accomplish what mentorship or apprenticeship does in our training. And, since people are our business, let us not lose sight of the fact that we need to invest adequate resources in their training and constantly look for ways to improve it. Our system of schools deserves funding that is competitive with that reserved for R&D and new equipment fielding. After all, good equipment in the hands of a poorly trained and led force does not provide us with the kind of warfighting capability our nation demands.

CHARLES H. BENSON III  
CPT, AR  
Ft. Hood, Texas

### Tank Crew Proficiency Course (TCPC) without MILES

Dear Sir:

Over the past 17 years that I have been assigned to MTOE units, I have seen a lot of changes in the way we train. One of the biggest changes was the use of MILES, LTIDS, and scaled-down targets. I tend to

question the gain we realize from conducting Tank Tables III and IV with these training devices. Are they truly training multipliers?

First, we must look at the objectives of Tank Tables III and IV:

1. Proper gunner techniques, i.e., always aiming center mass.
2. Switchology.
3. Target acquisition.
4. Fire commands and subsequent fire commands.
5. Crew drill, with a **four-man crew**.

Let's take a few minutes and examine the following — the use of the above-mentioned training devices versus the use of alternative method. With MILES, we are able to allow the crew to see the results of their efforts. The crew gets to make targets fall down. This is great...or is it? I've talked to a lot of crews and, with their assistance, I have come to these conclusions.

1. Crews tend to aim all over the target when the target fails to fall. They do this by applying BOT (Burst on Target) methods until they get the desired results — the target falling down. Why would they do this?

- a. LASER Safe Filter not installed.
- b. No reflective devices on the targets to get a return back. This produces gunners that fail to verify their range because no range gets displayed through his GPS.
- c. Commanders are more concerned with seeing targets falling, and forget about the primary purpose of lower tank tables, crew coordination.

2. Loaders are not very involved with the conduct of TCPC when MILES is used. He may arm the arming lever, may open the ammunition door, or may not even be present at all.

3. Valuable training time is lost every time we have to stop and fix the broken or inoperative MILES, LTIDS, or replace weak batteries.

4. Crews rarely practice malfunctions with great efficiency with MILES, i.e., stuck Aft caps, breach up, or even misfire procedures.

5. Now, after looking at all the above, we can say the following:

- a. Without the loader, we lose 25 percent of our training value off the top. He is an intricate part of the crew. He is highly involved with the correction of malfunctions. His loading abilities play an intricate part in crew coordination.

- b. We lose the ability to train our tank crew evaluators in the art of timing and conduct of a course which, if trained, could play in how well a unit can prepare for Tank Table VIII.

- c. Gunners can pick up bad habits by aiming all over the target trying to hit the sensor.

Remember, the above are comments gathered by talking to tank crews and are not my own opinions.

Now, let's look at the alternative way. Get rid of the MILES, and LTIDS. Then incorporate the use of the simple training device, the 120-mm Rubber Training Round. By use of the round, you are finally able to integrate your loader as a fully participating member of the crew. He will finally learn his place in the crew prior to going to a live-fire facility.

Here are ways that you can incorporate the alternate training method and the loader and make major progress in preparing your crews for live fire.

1. Have each crew arm the gun, lower the breach while the Aft Cap Deflector remains in the raised position. The loader must now place the gun in the safe position, choose the proper round (SABOT or HEAT), load the gun and announce "up" or "HEAT loaded" which in turn allows the tank commander to actually wait for the second round to be loaded before announcing "Fire."

2. TC takes an Aft cap, places it in the main gun. During the engagement, the loader announces "Stuck Aft cap" and then the crew goes through the emergency procedures.

3. TC places an Aft Cap in the main gun and raises the breach to the fully closed position. During the engagement, he or the loader announces "Breach up." They then go through the proper procedures.

4. Loader loads the second round for each engagement, allowing him to use the "EL Uncoupled" in the defense and on the move. This is not only valuable to his training, but also to the rest of the crew, ensuring they are used to the motion of the gun locking at 0 degrees and then returning to the target when the gun is placed in the armed position.

5. This allows the crew to go through the proper misfire procedures with the use of a main gun round.

6. The entire tower crew, from the timers to the person listening to the jump, gains valuable experience in proper timing and scoring techniques of malfunctions to perfect engagements.

I can only say that unlimited training opportunities are gained by training the alternate method. I understand there will be considerable arguments about not using the MILES and LTIDS. So, try and think of it in an unbiased way. You can use the MILES and LTIDS and only train tank commanders and gunners or you can train a full-up crew. Remember, the lower tables are to train a full tank crew in crew coordination and then test their abilities. Tank Tables V through VIII train and test the crew's ability to hit and destroy targets with all tank-mounted weapon systems.

SFC BOBBY D. JONES  
Master Gunner/Platoon Sergeant  
A/2-64 Armor

## Assault Gun Battalion 96 — The Author Replies

Dear Sir:

I read the responses to my article, "Assault Gun Battalion 96," with some interest. I appreciate MAJ O.T. Edwards' efforts to correct some of my more fallacious assumptions, which were based on information gaps (and I applaud the inclusion of the infantry phone in the design). I am concerned that the same Level Three armor that makes the vehicle more protected against RPGs and the like will also make it harder to deploy by air. This, however, is a METT-T trade-off and what we as leaders get the big bucks for.

However, I am afraid that CPT Michael Stollenwerk missed the point. The doctrinal focus of the Assault Gun Battalion is not WWI, as he claims, but Vietnam. That is to say armored forces employment in Low Intensity Conflict (LIC), which is where the light divisions, by design, spend most of their time. CPT Stollenwerk's points about exploiting the mass, speed, firepower, and shock effect of armor are well taken. In my four years as a company and battalion S3 observer controller at the NTC, I developed a fine appreciation for these principles. However, we would do well to bear in mind that not every conflict we will encounter is DESERT STORM. Armor also has a role in LIC as Vietnam, Grenada, Lebanon, Panama, and Somalia have shown us. Although there was some massed use of armor in Vietnam (mass being a couple of squadrons of an ACR), for the most part armor involvement in these conflicts involved company-sized units or smaller attached out to infantry forces or providing specific functions like convoy security. I recommend highly SGT Ralph Zumbro's book, *Tank Sergeant*. When you read past the "hoo-ah, I was there" war story tone of this book, you will find all sorts of useful nuggets for armor operations in LIC environment. Training to do well in this environment means that we will have to do things differently, like cross-attach armor companies and platoons, conduct gunnery in conjunction with dismounted infantry, and learn to move slowly in conjunction with foot troops.

CPT Stollenwerk also makes the rather bizarre point that a cross-attached AGS could be utilized by the infantry for moving water and ammunition across the battlefield. The implication in his statement is that this would be a misuse. While as an infantry leader I would not normally think of using an AGS (or a tank) in this manner, one can never say never. I seem to recall reading in *ARMOR* a few years ago about one of the great tank actions of WWII, where a German Panther tank in Vienna towed a trailer across a bridge under fire and carried ammunition and food inside for infantry troops defending on the far side. The tank then went on to destroy multiple

Russian tanks and break up several attacks, ably assisted by the infantry it had resupplied. Our own Army's history in Vietnam is replete with stories of tanks being used to rescue troops pinned down under fire, by pulling them through the bottom escape hatch. I would not lightly take the firepower of the AGS from its primary duty of direct fire support of the infantry, but I would not hesitate to do so to rescue some troop pinned down where we couldn't get to him, or get ammunition across an open space that was covered by small arms fire (if no other vehicle, like an M113 or BIFV, were handy). I am sure CPT Stollenwerk's experienced Armor NCOs would not balk at this.

In summary, the Assault Gun Battalion would have to be prepared to operate across the full spectrum of conflict. The battalion could perform some missions as a battalion in a higher intensity scenario. Indeed it could be the only element of a light division to deploy to combat, as I pointed out in my article. However, much of its time would be spent in the messy (and more frequent) world of LIC employment. We cannot become tactically blinkered into only one way of doing business. Armor officers must be prepared to support the dull grind of LIC as well as be the Combat Arm of Decision.

MARTIN N. STANTON  
LTC, IN  
Brandon, Fla.

## The "Gavin" Armored Gun System

Dear Sir:

I propose that the new Armored Gun System (AGS) be named in honor of the WWII commander of the 82d Airborne Division, MG James Gavin.

Naming the AGS for General Gavin would be a tribute to his leadership and devotion to the Army. The "Gavin" would be a fitting legacy to his honor and memory. What better way than to name this vehicle which will be deployed with his division?

SFC CRAIG C. MOSHER  
Ft. Knox, Ky.

## 2d Tank Battalion, 9th AD To Hold Reunion in September

The 2d Tank Battalion, 9th Armored Division will hold its annual reunion September 7-10, 1995, in Memphis, Tenn.

For more information, contact Elvin Littlejohn, 3428 Dupree, Memphis, TN 38115, phone (901) 362-2116; or Ruth Ganser, 713 5th St., Mosinee, WI 54455, phone (715) 693-3104.

# Reverse Déjà Vu

by Paul S. Meyer

When the first impression is so deep, there are some things you never forget. And so I was not surprised at the rush of feelings that accompanied my return to the driver's compartment of a tank after an absence of over thirty years.

The reclining position was new, and different from what I had experienced in familiarization with M48s and M60s, and so were the controls, but the white paint, the responsiveness and sound of the engine (even though turbine instead of diesel piston), and the feeling of the vehicle moving over the gently rolling terrain remained the same.

Our crew had just engaged several enemy tanks with success, and the commander wanted us positioned just to the left of a burning vehicle near the rise of a hill. "Defilade?" I asked over the intercom.

Hearing no answer, I took that position, and because the rise was steep I was looking at blue sky through my three periscopes. "Move up a bit further, driver," came the command, so I did, and now could see the terrain ahead.

To my great surprise we faced, alone, a battalion-sized advance by the enemy. The commander began to engage an enemy tank to the left, and succeeded after firing several rounds. But this did not make a dent in the force to our right which was coming at us now with considerable speed.

Just as I was going to ask the commander about a retrograde move, a round hit, the sound of the engine spooling down could be heard and the master light came on. "I'm getting the master light and warning lights," I told the commander on the intercom, "I think we're down." Before any answer could be made, the sound of another hit followed, shaking the inside of my compartment and everything inside went dark.

I could see my mistakes almost as I had committed them, as well as those of the commander. I didn't need an after-action review, but it would be useful.

I later realized that this tank, I think an M1, had a two speed reverse, as well as combat idle which I could have employed, and while I was concerned about taking the main tube off target by moving (on 48s and 60s you didn't fire the main gun on the move), I think there are gyro mechanisms to manage that on this vehicle. Anyway, moving to another position would have been the right thing to do, to enable us to continue to fight. We had mobility but didn't use it, in part because I was waiting for an order from the commander, and in part because he was busy and I was out of the loop.

The elements of this exercise kept playing through my mind for days after the 1995 Armor Conference, and left me with the desire to do it again, to do it



right, to try this problem over in different ways, and to try other problems.

And I could have, too, because did I mention that this tank was a simulator? Yes, the view through the periscopes was computer generated, but real enough, and in fact so convincing that while the simulator is stationary, you "feel" motion because the view through the periscopes is your only reference to the outside. You get caught up in, and taken over by, the situation. Action sounds could be both heard and felt in the driver's compartment.

It's true that nothing can replace actual maneuver in a tank in the field, with other tanks and troops, as we did in AOB 11 in 1963, firing blanks in the main gun during problems, or firing real rounds from the main gun on Hackett or Dorrets Ranges as we did.

But Simnet provides reality enough that the pressure builds and my hands began to sweat. And it also provides the opportunity to see the whole battlefield from an aerial view, and to replay a situation. It also provides a common, integrated experience for the whole crew which can be fully observed by instructors, and that facilitates rapid learning.

Weeks later I still can't get the exercise out of my mind, and continue to revisit the experience. I wish we had it in 1963.

---

*Paul S. Meyer is a 1962 Distinguished Military Graduate and Armor Association Award recipient from the University of Cincinnati. He completed AOB in May, 1963, and after graduation was assigned to the Staff and Faculty of the U.S. Army Armor School, serving concurrently as USAARMS Information Officer and Chief of the Visitors Branch until March, 1965. He also completed Armor Officer Career Course through Phase II. He holds an MA in English from the University of Cincinnati and an MS in Management of Rehabilitation Services from DePaul University, and for most of the last 30 years has been a counselor and evaluator in service to persons with disabilities.*



# Company Command in Korea

by Captain Bradley T. Gericke

*It is in the minds of the commanders that the issue of battle is decided.*

—B.H. Liddell Hart

Nothing in the Army today compares with the challenges of tank company command in Korea. The threat posed by the massive conventional forces of the North Korean People's Army is increasingly menacing, especially as they are poised only 20 kilometers from the garrisons of the 2d Infantry Division's tank battalions.

Thus a renewed sense of urgency and purpose inspires today's armor leaders who live and work minutes south of the Demilitarized Zone. The mounted warriors of the 2d Infantry Division have become the weighted main effort for the Army's armor force, and in re-

sponse, company commanders have developed a number of techniques to successfully prepare their units for combat in this professionally rewarding but difficult theater of operations.

Service in Korea is unique. The peculiarities imposed by rugged terrain, an uncertain foe, harsh climate, and high personnel turbulence means that armor leaders at the company level face wide-

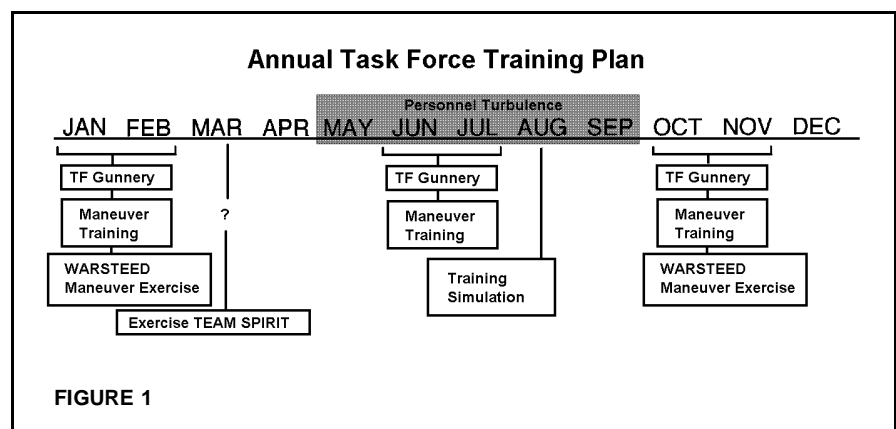

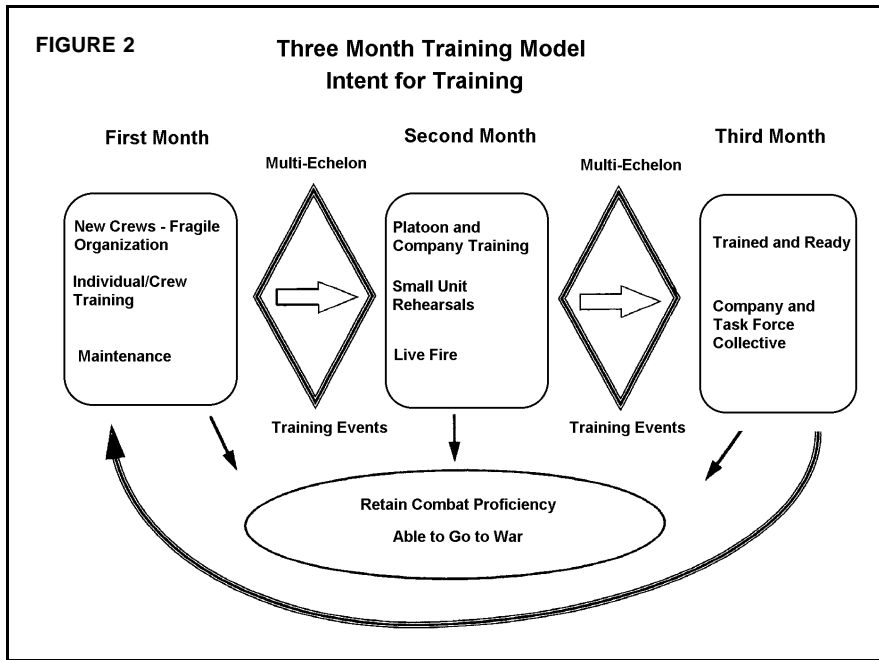

ranging challenges that must be overcome in the midst of a dynamic mission. Building a cohesive, trained company team can prove a sometimes elusive goal if one is not prepared. A tank company that can deploy to successfully defeat the enemy on the day of battle must overcome these obstacles now, in peacetime, and do so within the context of training, maintenance, and soldier programs that specifically address the ground truth reality of Korea-specific imperatives.

It is by now a familiar cliché that, as leaders, we must be ruthless trainers. Ruthless to prepare by allocating time, resources, and intent. Ruthless to execute to standards outlined in MTPs, manuals, and war directives. And ruthless to review, retrain, and capture lessons learned. So it is in Korea, except that training must also follow a strict cycle that maximizes home-station opportunities while emphasizing fundamental soldier skills and SOPs.

The current training paradigm within the 2d Infantry Division (Figure 1), allows a task force to fire a gunnery three times a year, usually in Jan-Feb, Jun-Jul and Oct-Nov. Gunnery is tactical, meaning soldiers live out of assembly areas, thereby providing the commander opportunities to practice crew and platoon maneuver skills concurrently when not live-firing. In addition, a major maneuver exercise, named Warsteed, in which the entire task force participates, occurs during the winter campaign season between Nov-Feb. Warsteed is designed to replicate the

CTC experience in its entirety, complete with OCs and full-up MILES. Two other exercises are scheduled to happen annually, but their precise timing is always a question. March is the month commonly designated for the annual Team Spirit Exercise, while in August, a peninsula-wide training simulation usually occurs.

If and when these events are held, they require significant leader involvement and often, soldier participation as well. Good intentions aside, expect the company and task force to cease any collective training — the NCOs can use this time to reinforce individual skills. And although soldiers come and go all year, the summer months see the greatest changeover. At least one-half of the company will change duty stations between May and September.

Before adopting any training program, the company commander must recognize and understand this single, overwhelming reality that influences everything that occurs in the life of the company: personnel turbulence. A 12-month tour of service means that in the course of one year, every soldier in the unit will arrive, serve his tour, and depart. This sounds obvious, but the implications are profound and not so apparent. In fact, and especially in the case of key leaders, turnover is greater than 100% — replacements arrive early and assume their duties, the battalion must often fill requirements, the normal drain of details and “SDs” occurs, emergency leaves are common, and occasionally soldiers depart for reasons of personal hardship. Not to mention that every soldier takes time to inprocess and outprocess and is normally granted a 30-day mid-tour leave.

The commander is thus confronted with an extraordinarily short time to meet numerous demands: major collective training to execute, a General Defense Plan mission that must be taught, maintenance both scheduled and routine to be accomplished to Army standards, and the usual complement of missions, assignments, simulations, taskings, and distracters that always seem to arrive at the most inopportune moment. And all of this must be done with crews and platoons who have usually been together only a short period. It is truly a situation of packing three years into one.

But the means to achieving excellence — as defined by a proud unit that accomplishes both training and GDP missions, maintains its equipment, and takes care of soldiers — is very possible. Unfortunately, most commanders

**Example: Scheduled Service Plan**

	1st Week				2d Week											
	FR	SA	SUN	MON	TUE	WED	THU	FR	SA	SUN	MON	TUE	WED	THU	FRI	SA
1st Platoon	R	M	M	H	H	H	T	T	M	M	T	C	C	C	R	M
2nd Platoon	R	M	M	T	T	T	C	C	M	M	C	H	H	H	R	M
3rd Platoon	R	M	M	C	C	C	H	H	M	M	H	T	T	T	R	M

R = Road March  
H = Hull Phase  
T = Turret Phase  
C = Commo, Weapons, NBC, Personnel  
M = Makeup

**FIGURE 3**

only figure out how to do it about the time they change command. I offer here a few suggestions to give the new company commander a head start.

In terms of scheduled training, a three-month training cycle (Figure 2), reinforced by clearly enunciated and rehearsed SOPs, is a model that enhances the company's collective readiness by shadowing the standard schedule found at the task force. Repetitive training, focused on unit fundamentals, is a must. In this three-month cycle, the first month is committed to basic soldier skills and leader training. (Ideally, vehicle services as well, discussed below.) The second month focuses on crew and platoon collective skills. These two months aggressively maximize home station training opportunities. The third month highlights platoon and company training conducted in conjunction with the task force deployment.

These are areas of emphasis only. Never does the commander state, "This month we'll train individual skills. ISG take charge." Because of the company's real-world readiness requirement, the necessity to maintain proficiency across the training spectrum is an imperative. But by declaring a focus, the commander and his leaders strive to build upon weaknesses and enhance strengths. It is pointless to schedule training that does not reflect the activities of the battalion, because the battalion's training will dictate the availability of resources for the company. For example, while the battalion is in garrison, individual and crew training must take priority so that when the battalion and company deploys, the company may maximize the scarce resources of bullets and maneuver land. Waiting until the unit is deployed to train crew drills is a waste of everyone's time.

While in garrison, aggressive imagination is called for. So is intensity. Take a look at how much the UCFT is used. It's a great training tool that frequently goes vacant while crew proficiencies wither from lack of practice. Time is frequently available during the evening or on weekends for leaders intent upon improvement. Other ideas: conduct tactical roadmarches enroute to TCPC, wear MOPP during maintenance periods, train at night in the motor pool, execute notification and load-up drills at company level, etc. The possibilities are endless. The point is that, with a little determination and en-

couragement from the commander, your junior leaders can be excited about training all of the time, not just "in the field."

At all times, the NCOs must own the company's individual and crew training. They will have to be innovative to find the time to train those tasks. The commander will not have the luxury of scheduling individual training as an implicit event. Rather, training is always multi-echelon. If a tank commander knows his crew needs work on donning their protective masks, perhaps bringing the mask to morning formation and practicing after the ISG finishes his business is the time to do it. Or maybe the crew can accomplish TCGST training while conducting command maintenance or weapons maintenance. In other words, no training event can ever be just one task. The unit focus will of necessity weigh heavily on the collective training side, so NCOs must meet the individual training challenge by being creative and aggressive.

Officer training needs to be frequent and intense. At any given time, two of the platoon leaders will most likely have no experience whatsoever. And the XO will be junior himself, with maybe two gunneries and one or two opportunities to deploy to the field with his former platoon. So the commander must remain hands-on, training the lieutenants on the fundamentals through a variety of means: sandtables, terrain walks, discussions of FMs, or map exercises. Investing three or four hours a week here pays big dividends for the commander, the unit, and the lieutenants.

It is an Army tradition that maintenance is training, and for that matter, that maintenance is everything. In Korea, the challenge is no different. However, once again, personnel turbulence plays a role. Soldiers assigned to various pieces of equipment such as NBC, mine detection, or SINCGARS, may be new to those items and require training, not only on operation but maintenance and upkeep as well. And as long as the MIIP is deployed to Korea's tank battalions, refresher training is necessary on its differences, such as weapon systems, suspension, and collimator.

The extreme cold of winter and the harsh humidity of summer take a toll on equipment. Seasonal preventive maintenance measures are critical (Don't forget to rigorously prepare soldiers too — another great training topic, and absolutely important). Maintenance must

be a command priority, reflected on the training schedule, and reinforced by the presence and participation of leaders.

A technique to complete the company's semi-annual service within the first or second month of a three-month cycle is to execute a company service (Figure 3). This ensures command emphasis and allows the commander to service all of his equipment and soldiers concurrently. The commander coordinates with the battalion for resources, and emerges in a higher state of maintenance readiness because the unit has conducted one mission with the entire chain of command's involvement. That level of experience and leadership is critical for solid maintenance in Korea's tumultuous atmosphere.

None of this is profound in any sense. I don't claim originality for any of these techniques. But I have tried a few myself, watched other commanders successfully execute some, and was taught a number by my own leaders. Each has been published, proven, and practiced by commanders and units throughout the Army. To succeed in the dynamic, demanding conditions which are the routine for the Army in Korea, these fundamentals are essential, underwritten by rehearsed SOPs. Nowhere else is the margin between unit excellence on the one hand, and collective fragility on the other, so razor thin.

Command in Korea is invigorating because of the urgency of the mission and the ever-present commitment of our soldiers. They deserve the very best training we can offer. Our nation demands nothing less.

Captain Bradley T. Gericke received his Armor commission from the U.S. Military Academy in 1988. A graduate of Armor Officer Basic Course, Armor Officer Advanced Course, and the Joint Firepower Control Course, he is currently attending graduate school at Vanderbilt University. He has previously served as a tank platoon leader, tank company XO, and battalion adjutant with 2-67 Armor in Germany; as BMO, HHC 2-72 Armor, and company commander, D Company, 2-72 Armor, Korea.

# Light Armor Units: An Italian Perspective

by Colonel Sergio Fiorentino

Light armor units are not new for the Italian Army. In fact, during the 1950s and 60s, the Italian Army had cavalry regiments equipped with light armored vehicles and armored cars. The main task of these units was ground reconnaissance and, due to their high mobility, they were also used as reaction forces or reserves during offensive and defensive operations. The increased importance of armor at the end of the 1960s resulted in a reorganization of cavalry regiments into heavy armored and mechanized infantry regiments, thereby eliminating the cavalry unit for more than 20 years.

More recently, with growing urbanization and cultivation all over Italy, especially of vineyards and corn, there have been fewer opportunities to use extended formations of heavy armor units. In many areas, movement has been strictly confined to roads. Moreover, limited lines of sight and fields of fire, due to crops and hilly terrain, also restrict the use of armor. As a result, we realized that we had a greater need for tank killers than tanks for counter-maneuvers. Furthermore, the continuous development of our doctrine, and the means necessary to support it, have been greatly influenced by NATO and internal defense requirements. To respond to these changing conditions, the Italian Army reconfigured armored and light infantry components several times.

In the new scenario, our Army will be focusing on "defense of something," rather than "defense against someone." In addition to the standard factors to be taken into account, such as natural environment, threat, resources, and technology, a new compelling factor will be both tactical and strategic mobility. Forces on the battlefield of the future will demand speed over long distances to rapidly concentrate, react, and dis-

perse. There is also an increasing requirement for power projection capability over long distances to support multinational coalition efforts. In average conditions, it is more effective to employ light-medium armored units for defensive, offensive, and other-than-war operations.

For the conventional threat, rather than employ only extended formations of armor, it is better to use a mix of artillery, combat helicopters, and light infantry (air assault). These types of forces have greater mobility and are more effective in rough and mountainous terrain.

Both the rapid increase in the lethality of high-technology and antitank weapons and the increased effectiveness of target acquisition for both day and nighttime systems makes it even more difficult to maintain a modern armored force.

The continuously expanding and rapidly evolving technology has made it more important than ever to optimize the cost-effectiveness of our Army's limited economic resources.

As technology has evolved, the Italian Army Staff thought it better to establish an armored cavalry brigade and seven armored cavalry regiments to be integrated with existing units (mechanized, mountain troops, and airborne). This effort, which was initiated in 1991 and will end in 1994, is aimed at producing units that can operate in diverse types of combat conditions. In this regard, our primary concern is in determining likely areas of potential operations, which nowadays are not always easily identifiable.

Another consideration is command and control organization. The C<sup>3</sup>I system must be responsive to the entire battlefield, both forward and rear. The contingent must be mobile and effec-

tive with the use of modern weapons and technology to engage objectives at great distances, and be able to concentrate maximum forces and firepower at the place and time of our choice.

Another aspect of the modern battlefield is the array of forces. Units are often highly dispersed, and battlefields are no longer linear. This results in areas that cannot be constantly controlled by forces, fires, or obstacles. Ultimately, we can see that future operations must be:

- Characterized by maneuvers that are highly synchronized. Elements of surprise will concentrate more on the "timing" than on a particular geographic location
- Aimed first at destroying enemy forces and then at securing specific objectives
- Conducted by resorting greatly to reconnaissance and deception
- Carried out with a higher degree of risk than in the past
- Able to transition, particularly at the tactical level, from defensive to offensive and vice-versa without hesitation.

The modern battlefield, as defined above, increases the potential use of light armored units, which rely on increased operational mobility and flexibility. The light armor units, therefore, must be highly mobile and versatile, utilizing high-speed movement to rapidly react from one location to another and able to accomplish a multitude of combat missions.

## The Role of Armor

In the configuration to be outlined, the Italian light armored unit can be effectively employed for many types of operations on the modern battlefield. In



## Italy's Centauro

This 26-ton armored car has a maximum road speed of over 60 miles per hour and mounts a 105-mm gun on its eight-wheeled chassis. Ammo storage locations (for 40 rounds) are seen at right. The cannon fires standard NATO ammunition, including APFSDS rounds, with the help of a long-recoil mount and muzzle brake. The front two axles and the rear axle all move to steer the vehicle, allowing a turning radius of less than 30 feet.

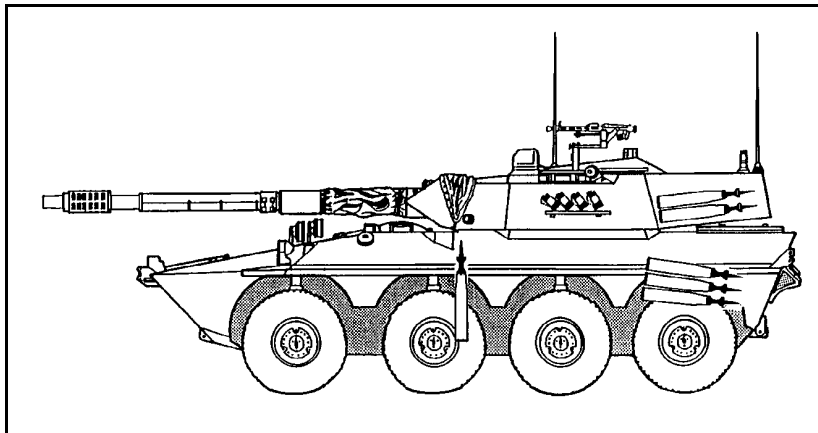

### SPECIFICATIONS

- Crew of four
- Power: V-6 520-hp diesel
- Power/Weight Ratio: 21hp/ton
- Range: 500 mi.
- Hull Length: 24 ft.
- Hull Width: 10 ft.
- Overall Height: 8.8 ft.



particular, it is well suited for defensive and offensive operations, as well as internal defense and peacekeeping missions. In offensive and defensive operations, the units can conduct reconnaissance and security missions of a selected position or area, deep operations in enemy rear areas, as well as diversionary or supplemental operations. Planned future missions for light armored units include the defense and security of particularly sensitive areas and positions, rapid reaction against infiltration, and military support for internal emergencies. Finally, for peacekeeping missions, light armored units can perform border patrol, area security under international direction, and security of routes and key locations.

To best carry out these duties the brigade is organized as follows:

- Brigade headquarters and headquarters battalion. The headquarters battalion includes a support company, a

signal company, and an engineer company.

- Three armored cavalry regiments. Each regiment includes a support troop and a cavalry squadron. Each cavalry squadron should include four light armored troops (two troops on Centauro wheeled armored cars and two troops on light personnel carriers).

- An artillery regiment that includes an artillery battalion, three batteries of 155-mm howitzers, and an antiaircraft battery. (We are considering the possibility of installing the 155-mm gun on the armor car hull and of adding a battery with FIROS rocket launchers);

- The support battalion.

This configuration lends the armored cavalry brigade some unique characteristics. The most important include the capability to conduct sustained operations. This is possible due to the large number of units and different types of weapons systems that may be

employed, and the capability to develop dynamic combat operations over large areas, supported by the extended range and high speed of combat vehicles over all types of terrain.

Another characteristic of the armored cavalry brigade is the interoperability of each component and the ability to reconfigure the force to support any kind of mission. Furthermore, the brigade has effective antitank capability at extended ranges, due to the guns of the armored cars and other TOE-authorized antitank weapons. In addition, there is TOE antiaircraft capability adequate for the brigade to operate autonomously.

All these characteristics of light armor units, combined with the high "esprit de corps" and traditions of the cavalry, contribute to the brigade's ability to perform on a dynamic battlefield. The cavalry brigade can be used as a single combat unit or task-organized into smaller units. As a separate brigade, it can conduct operations includ-

## The Puma

The Puma light armored scout vehicle weighs approximately 5 tons, and has room for six men, including the driver. It has a maximum speed of 100 km/h and a range of 800 km.

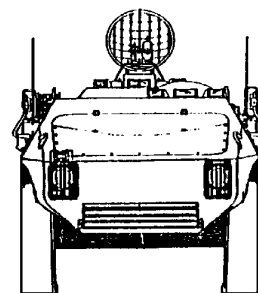
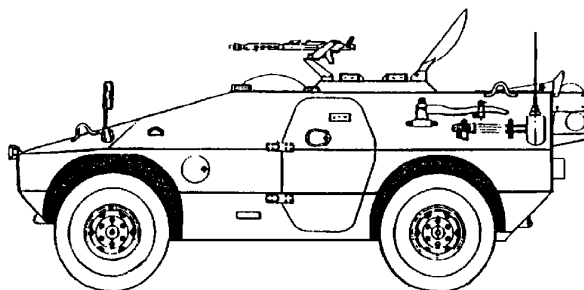

ing reconnaissance (to establish and maintain contact with the enemy), area security, and deep operations in enemy rear areas.

The brigade can also be task organized for smaller missions, such as reconnaissance (for the brigade itself), area security, mobile reserve, mobile reaction force, point security, support for internal emergencies, and peace-keeping missions.

### Light Armored Vehicles

The most important armored vehicle of the light armor unit is the Italian-made armored car, the Centauro, that equips cavalry regiments of the brigade.

The Centauro is a new type of wheeled combat vehicle that will have an important role in increasing the operational capabilities of units on the modern battlefield. The performance of the Centauro places it between the light tank and the main battle tank. The primary characteristic is the Centauro's high mobility, nearly the same as that of tracked vehicles on all types of terrain. This is due to the four drive axles, the centralized tire-inflating system, and its range of approximately 800 km. Another capability is the Centauro's high road speed (100 km/h), which is achievable because the vehicle is relatively light (24 tons). Furthermore, the vehicle has increased armor protection achieved by a composite of high resistance steel and plastic. The armor will resist shrapnel, automatic-arms fire, or heavy weapons. This armored protection is believed to be adequate considering that the Centauro is to be used for hit-and-run-type missions, due to its high mobility. Another key characteristic of the vehicle is its high survivability in NBC environments and in case of internal fires. This is made possible by a pressurized NBC filter system and an internal fire-extinguisher system. The Centauro also has suffi-

cient firepower to engage the most modern main battle tank, with its primary 105-mm gun and battle load of 40 rounds. Naturally, the Centauro is continually evolving with the newest technology. Even though 90 vehicles will be in service at the end of this year, we are already looking at improvements that can be applied to future models. The first improvement will be the capability of transporting 2-4 combat soldiers in addition to the vehicle crew. This will extend the vehicle's possible mission profiles. We are also studying the possibility of adding a laser warning device, which will intercept emissions of enemy laser range-finders and react by pinpointing the enemy vehicle location and activating a protective smoke shield within one second. Finally, we are considering the installation of a new system to electronically control the turret. This would consist of two brushless motors, similar to those in the Leopard 1, but with improved electronics. The motors are also smaller and consume less energy.

In the context of this project, we are considering an entire family of vehicles that would utilize the basic hull of the Centauro. In each vehicle model, such as the command-and-control vehicle and the self-propelled, 155-mm howitzer version, there would always be trade-off capability to rapidly incorporate new technology. For the light components of armor cavalry units (each squadron would be organized with two Centauro platoons and two platoons on light recon vehicles), we are considering possibly buying a light armored recon vehicle, the Puma made by IVECO. The main specifications of this vehicle are a weight of approximately 5 tons, room for six men, including the driver, with light armament of various types. The Puma has a maximum speed of 100 km/h and a range of 800 km. The vehicle must initially be built as a troop carrier. Later modifications would include versions to carry mortars or antitank missiles, and command-and-control and evacuation vehicles.

### Conclusion

I have tried to present the Italian perspective on light armored units and the changes being made by the Italian Army to increase flexibility and mobility of these newly organized units. Combined with air-assault units, light armored units are at the forefront of current doctrine, particularly in relation to the many requirements of non-traditional national and international operations, such as peacekeeping, peace-enforcing, and security missions.

Colonel Sergio Fiorentino is a 1968 graduate of the Italian Army Military Academy, commissioned in artillery. As a second lieutenant, he attended the School of Applied Military Science, and was later assigned to the 5th Mountain Artillery Regiment as battery executive officer. As a captain, he commanded an artillery battery, and was later assigned as staff officer to the Landsouth Operations Division. He attended the Italian Army War College and was appointed Vice Section Chief of the Italian Army General Staff Information Systems Division. From 1986-1989, he commanded the 8th Self-Propelled Artillery Battalion of the "Vittorio Veneto" Cavalry Brigade. Subsequently, he was assigned to the Italian Army General Staff as Section Chief of the Information Systems Division. In 1991 Colonel Fiorentino was appointed Assistant Military Attache of the Italian Embassy - Office of the Army Attache in Washington, D.C.

# Depleted Uranium Without the Rocket Science

by Captain Pat Paulsen

After Operation DESERT STORM, it comes as no surprise that depleted uranium, or "DU," forms a vital new part of our modern arsenal. Currently increasing both the protection of armor and the effectiveness of sabot penetrators, DU rounds are also used in the A-10's 30-mm gun and under development for the Bradley's 25-mm cannon. However, users of depleted uranium need to understand the possible hazards of our latest technological wonder to help improve their effectiveness on the battlefield.

## Basics

Radioactivity is the spontaneous emission (or "spitting") of alpha and beta particles or gamma rays from an atom as it decays into a different element. These emissions are called ionizing radiation. Depleted uranium is uranium ore that has been processed to remove the material useful for nuclear reactor fuel and nuclear weapons. Since the type of uranium ore that is left, U-238, makes up about 99 percent of uranium ore, plenty of depleted uranium is available to anyone with either nuclear reactors or weapons programs. This residue is a dense, heavy metal with a limited health hazard, that is still easily made into various products.

DU has two properties that make it ideal for military applications: it's extremely dense, and its surface ignites on impact (especially with steel). Unfortunately, most soldiers stop reading about DU when they get to the word "uranium" and immediately assume that it's radioactive and will kill them unless they take elaborate precautions. **WRONG!** DU mainly emits "alpha" radiation. Although alpha may cause the most damage to cells and tissue (compared to beta and gamma), they can't penetrate heavy clothing or skin. The beta and gamma radiation emitted by DU, even inside a tank fully uploded with DU sabot rounds, is usu-

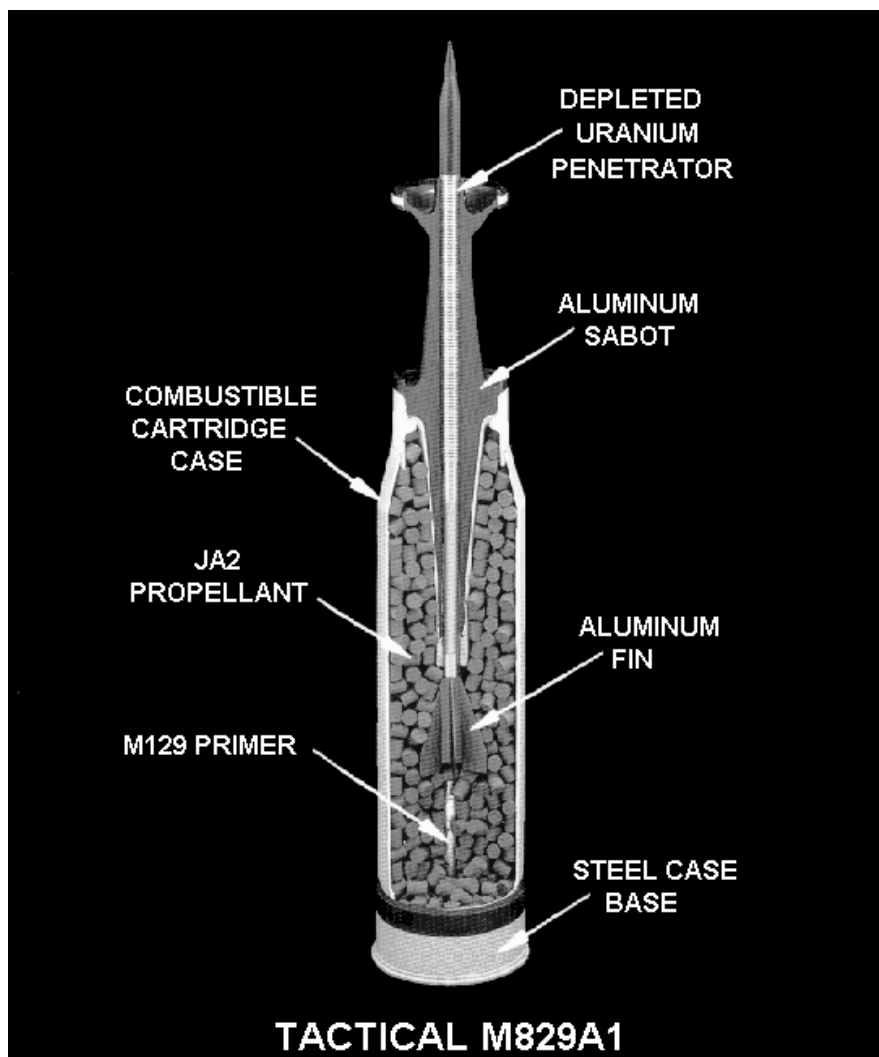

ally less than normal background radiation at many locations around the world.

## Hazards

The two main concerns about depleted uranium are heavy metal toxicity and slight radioactivity. Like lead and other heavy metals, DU is a poison inside the body (primarily to the kidneys). DU does not present an immediate external hazard, but is an internal hazard if a soldier has open cuts or

sores on the skin where the DU could enter the body. The internal hazard from radiation depends on how much DU is inhaled, swallowed, or gets under the skin. The alpha particles emitted by DU are most hazardous inside the body where the short range but high ionization of the particles damage internal tissues.

As a heavy metal (like lead), DU may make soldiers sick if eaten, inhaled, or it gets under the skin (through open cuts or wounds).

The greatest hazard from DU is the dust formed from impacts or burning. DU, basically, rusts when exposed to air, turning a dull black color. Impacts or fires can cause DU shrapnel or DU dust. This heavy black dust should be easy to identify if people take care to be aware of their surroundings. The main hazard of DU is inhaling the dust or accidentally picking it up and swallowing it if gloves aren't worn and the dust is not washed off before eating, drinking, or using the latrine.

Since DU dust is much heavier than normal dust, it is usually deposited within 50 meters downwind of the fire that generated it. The major long-term hazard from DU dust or other contamination is contamination of the ground and water supply. Take care to ensure mess, shower, and bivouac sites are not in an area of either known DU contamination or where DU dust may have been carried by recent rains, etc.

### Identification

DU penetrator impacts are easily identified. In addition to the usual small, well-defined impact hole, the DU penetrator deforms very little passing through the target and has an exit hole only slightly larger than the entry hole. Both holes will register as slightly radioactive on radiac detectors. DU contamination includes penetrator parts, spalling, and dull black heavy dust found close to the impact or fire. DU contamination can be detected by AN/VDR-2 and AN/PDR-27 radiac meters, and the only way to confirm DU contamination is to identify the slight radioactivity where you wouldn't normally expect to find any.

### Avoidance & Protection

The basic principles of radioactive hazard avoidance are to minimize the exposure time to the radioactivity, maximize the distance between soldiers and the radioactive source, and use shielding (in this case, even cardboard, tape, and layers of paint are effective). The objective is to avoid contaminating soldiers and equipment and minimize the spread of contamination (specifically the DU dust). Mechanic's cover-

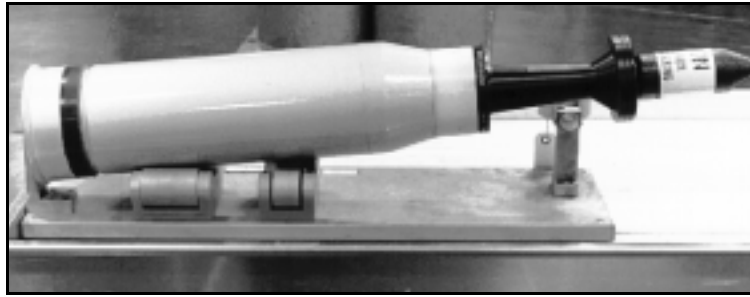

alls, BDUs, leather gloves, and BDOs won't allow the alpha particles from DU to penetrate to the skin. Protective masks should be worn for respiratory protection, or, if only working around the equipment for a few minutes a cravat (bandanna) over the mouth and nose or a dust mask will protect for short exposures. If anyone is injured while working around DU equipment or wreckage, rinse out any cuts with water as soon as possible in addition to normal medical care and use a radiac meter to confirm any suspected DU contamination for appropriate additional medical treatment.

If you find radioactive DU contamination on a vehicle, move the vehicle to a site away from water sources, food storage or eating areas, and occupied bivouac sites. Brush, scrape, or wash off the loose radioactive dust from yourself or equipment, staying aware of where it goes. Clean up or mark the area as needed. Fixed (non-moveable) or embedded DU contamination should be covered with duct tape or cardboard (alpha and beta radiation are the primary emissions from DU, so covering it over with adequate shielding will reduce exposure). If the measured level of radiation in the vehicle is less than .005 cGy/hr (centigray/hour) and the vehicle is operational or can be repaired at unit level, it can be used to complete the mission (based on a maximum unrestricted individual exposure of .10 cGy). Either remove the contamination or tape over it if you can't and, unless the vehicle needs to be repaired, it's able to continue the mission until you conduct radiological decon. Of course, always keep personnel away from contaminated equipment or terrain unless required to complete the mission. Report all DU contamination up command channels immediately after confirmation of the hazard.

Awareness of DU hazards and simple, common sense procedures will deal ef-

fectively with the problem and protect soldiers. Bottom line: unless personnel are directly involved in a detonation or fire with DU, hazards are relatively small and simple procedures provide effective protection. Address any additional

questions regarding depleted uranium to:

*Commander, U.S. Army Chemical School, ATTN: Director, Edwin R. Bradley Radiological Laboratories, Ft. McClellan, AL 36205-5000*

*DSN: 865-4489 or Commercial: (205) 848-4489*

### References:

CPT Doug Rokke, Ph.D., 1LT John Shank, & SFC Susan Wright. "Introduction To Depleted Uranium."

USACMLS. Tier 1 Awareness, Depleted Uranium and Low-Level Radiological Hazard Training Packet. 13 Oct 94 Draft.

Conversations with CPT Doug Rokke and SFC Dante Laciste, USACMLS Edwin R. Bradley Radiological Laboratories.

FM 3-3 Contamination Avoidance.

FM 3-4 NBC Protection.

FM 3-5 Decontamination.

Captain Pat Paulsen is a Distinguished Military Graduate of North Georgia College. He is currently the NBC Detachment Commander in the 5th Special Forces Group (Airborne) at Ft. Campbell, Ky., after a tour at Ft. Carson, Colo., and completing the Chemical Officer's Advance Course. He has been the Chemical Officer for a divisional cavalry squadron, mechanized infantry and field artillery battalions, and platoon leader for cavalry scout, mechanized smoke, and support platoons.

# The Lessons of Operation Desert Hammer VI: Our Doctrine Is Basically Sound

by Major Jeffrey R. Witsken

*But tactics, techniques,  
and procedures may change  
to fully exploit new systems*

Operation Desert Hammer VI (ODH VI) represented the first time that the Army fielded a battalion task force, digitally linked across Battlefield Operating Systems (BOS), and put it to a severe test at the National Training Center. The task force possessed over 120 digital systems that linked the key leaders of the task force with digital communications. Although the task force was not 100-percent digitized, significant doctrinal lessons did emerge from ODH VI that indicate the future direction of tactical warfare.

## Importance of Fundamentals

The overarching lesson of ODH VI was that fundamental combat skills remain essential for battlefield success. Leaders and soldiers must understand the essential business of warfighting. The extent to which lethality, survivability, and tempo are achieved depends upon the commander's ability to create favorable conditions on the battlefield. The commander must see the battlefield as a precondition for directing his unit to maneuver and shape the battlefield. Only by appreciating the terrain, enemy, and friendly forces can the commander identify and choose those times and locations at which favorable conditions can be achieved.

## Seeing the Battlefield

Author Stephen R. Covey remarked that, "How we see the problem is the problem." In a similar way, the real challenge to battle command is to act on a true picture of the battlefield, rather than an incomplete or false picture. Several of the systems used in



ODH VI reveal how future battle command systems will aid the combat leader.

The All-Source Analysis System (ASAS) provides access to nearly all available battlefield sensors (up to national level assets), permitting an "over-the-horizon" view of the enemy.

Scout platoon enhancements — second-generation thermal sights, driver thermal viewers, and hand-launched unmanned aerial vehicles (HL-UAV) — give the scout platoon "observation standoff," the ability to see the enemy well beyond his ability to detect.

Far-target designation (the M1A2's ability to accurately locate key terrain, locations, or enemy with its laser rangefinder) offers the ability to digitally paint a picture of the battlefield.

*Editor's Note: This is the second article in a series that analyzes Desert Hammer VI, an NTC test of digitally-equipped forces. The first article, in our last issue, dealt with materiel changes. In the next issue, training will be the focus.*

Future digital systems will offer "terrain analysis support systems," which permit detailed review of terrain using digital map databases and powerful computers. Leaders will be able to review elevation, conduct line-of-sight analysis, review weather effects, look at terrain in three dimensions, and even conduct movement rehearsals. This capability will greatly facilitate understanding of the battlefield, and will further benefit leader reconnaissance.

Digital systems that provide shared position location lead to better situational awareness. The Intervehicular Information System (IVIS), Battalion and Below Command and Control (B<sup>2</sup>C<sup>2</sup>), the Enhanced Position Location Reporting System (EPLRS), and other systems will complement a leader's situational awareness derived from personal observation.

## Improvements to C<sup>2</sup>

The use of the Battle Command Vehicle (BCV) during ODH VI heralds future changes to C<sup>2</sup> organization and facilities. In fact, we may eventually abandon our current C<sup>2</sup> architecture. In the interim, the introduction of digital workstations signals a shift from acetate overlays and status charts to "battle integration stations." BCVs will permit more of the planning and battle tracking to occur forward with the commander, perhaps reducing the role of the Tactical Operations Center (TOC) and Combat Trains Command Post (CTCP). Within BCVs and other C<sup>2</sup> facilities, the use of local area networks and file servers will permit different staff sections to simultaneously share the same data on their workstations.

---

Commanders must determine the role of the C<sup>2</sup> facilities, and the specific function of each battle integration station, situating them where they will best assist command and control of the unit. The commander, executive officer, and key staff members must have ready access to information on the battle integration stations.

NTC observer/controllers (O/Cs) identified that digital systems can accelerate the staff planning process, and will increase the quantity and accuracy of information available. Staffs must establish procedures to sift through the greater quantities of information provided and provide rapid staff assessments. Provided that information is regularly transmitted and updated, staff members should be able to accelerate their planning process and provide higher quality estimates to the commander. Prompt forwarding of warning orders and initial overlays permits improved parallel planning to occur, providing critical preparation time to subordinate units. These digital systems also cause changes in reporting formats and procedures (as these systems permit reports that are more complete, pre-formatted, and sent digitally).

O/Cs observed increased digital coordination of overlays and positions. There is potential for units to adopt what can be called a “continuous planning process.” This process features warning orders that expand in detail as time goes on. Updates in intelligence can be swiftly forwarded within the unit, and adjustments in plans can be quickly disseminated as well. If time is available, subordinate commanders may be able to participate in course-of-action analysis.

O/Cs also highlighted that digital communications increase the leader’s use of his valuable face-to-face time with his subordinates. Digital systems can be used to assist in the planning and coordination of operations. Staff updates and overlays, sent digitally, allow commanders and other staff sections to remain at more critical locations, rather than link up face-to-face to obtain information.

Such a procedure improves preparation time, allows key leaders to spend more time with their units, and permits greater use of parallel planning. Leaders will still communicate face to face with subordinates at critical times, yet be able to use this time to fully communicate their intent.

### **Synchronization/Massing Of Combat Power**

ODH VI provided many examples of the use of IVIS, POSNAV, and other navigation aids to move precisely to needed positions. This contributed to the ODH VI task force attaining higher percentages of direct fire systems participating in battles than non-digitized units. Larger numbers of artillery and mortar missions were also observed. Despite this, battle outcomes were not decidedly superior to non-digitized units. Clearly, simply “participating” in a battle, or firing more artillery rounds, are not the only essential features of battlefield success. Commanders must seek battle under favorable conditions.

During some ODH VI missions, although higher than average participation rates were observed, rounds fired and loss exchange rates were low. This can be explained by piecemealing, or engagement under unfavorable conditions, such that the task force was “chewed up” without gaining a clear advantage over the enemy. In other missions, participation rates and rounds fired per vehicle were above average, but enemy numbers were large as well, so that both enemy and friendly attrition were high (due to inability to create favorable conditions). This evidence suggests that the digital task force was not able to create favorable conditions during its missions. Future battle command system design must incorporate specific aids to facilitate the commander’s identification of opportunities for favorable conditions, and his ability to synchronize and mass combat power.

### **Expanded Battlespace**

O/Cs identified potential advantage from the ability to rapidly concentrate fires and maneuver assets at the critical points of the battle. The linkage with situational awareness, and increased fielding of advanced acquisition devices, could entail expanded battlespace for future battalion task forces. Simply put, the task force can initiate actions earlier (in both time and space) against the enemy. Operations should be structured to take advantage of this capability. Fires are directed to pin the enemy in place throughout the depth of his position. In the offense, a rapid tempo is attained which destroys the enemy piecemeal by swiftly biting off small elements of his force, destroying them, countering any enemy reaction,

and moving on to “bite off” the next portion of the enemy force. Systems capable of far-target designation are used to cover the enemy with artillery and mortar fire at key points.

### **Situational Awareness**

Interconnectivity and communications problems prevented realization of the full benefit of digital situational awareness. Screens did not display all possible icons and visible icons were frequently out of date. Generally, companies and platoons possessed situational awareness in their immediate areas, but lacked full awareness of other adjacent units. As operations progressed, interconnectivity proved to be fragile as units maneuvered and took losses. Therefore, tactical decisions were based on a partial appreciation of friendly positions and status. This lack of complete friendly situational awareness also impacted on fratricide.

There is a balance to be struck between visual situational awareness and digital situational awareness. Digital situational awareness cannot be expected to be as complete or timely as situational awareness that the commander observes for himself. Therefore, there are times when a leader must have his head out of the hatch and personally observe.

Digital situational awareness (watching the screen) should only be used as a supplement, and as a replacement only when visual situational awareness is not possible due to distance or limited visibility conditions. Of course, leaders at different levels will need a different balance between digital situational awareness and visual.

### **Integration of Digital Systems**

During ODH VI, units often executed basic troop-leading procedures, then worked with digital systems as time was available. NTC O/Cs and subject matter experts noted that digital systems must be fully integrated into troop-leading procedures if any benefit is to be realized. Digital overlays and task aids need to be considered a routine part of a unit’s preparation for, and execution of, operations. As such, preparation of digital equipment, creation of dissemination of overlays, digital Fragmentary Orders (FRAGOs), and other steps should be fully integrated into the time management process prior to operations.

## Breaching Operations

The ODH VI task force used its digital systems for precise execution of breaching operations, using several adjusted tactics, techniques, and procedures (TTP). Units accurately reported the extent and limits of obstacles digitally. When they located bypasses, the scouts could transmit the needed waypoints to the task force so that a bypass could be accomplished rapidly without units blundering into the obstacle. If breaching was required, covering fires could be established with greater precision. Far-target designation was used to direct fires that suppressed enemy locations and to call in obscuration at the desired points.

In the future, since the commander will have near-real-time confirmation of the covering force being in place, breaching assets can rapidly move up. Once the breach is made, the specific location of the breach can be rapidly disseminated digitally, and the exploiting force can move through and rapidly deploy on the other side of the obstacle.

## Fire Support Impacts

The ODH VI task force had over 25 systems that could digitally call for fire (M1A2s, IVIS-equipped Bradleys, and the Bradley FIST-V system). As a result, the number of potential observers on the battlefield multiplied dramatically. This multitude of observers, if uncontrolled, will create fire support management problems. During ODH VI, a fire support officer received 11 calls for fire within 3 minutes. FSOs must be prepared for greater peak demands. To avoid similar problems, units must have procedures to manage calls for fire. Systems with far-target designation capability may be designated as "observing vehicles." FISTs and FSOs must closely monitor calls for fire, ensuring that their commander's intent for fires is being met. In light of this, commanders must express detailed intent and establish flexible priorities of fires, as the increased tempo of the battlefield may render a fixed priority obsolete quickly.

As we gain experience with digital battle command systems, we may find that we can adopt radically altered fire support structures. Analyses at the NTC and simulation gaming both indicate that the value of indirect fires increases as the response time decreases. The greatest improvements in fire support lethality may come from linking howitzers directly to observers, cutting out

middlemen, and cutting the response time required for indirect fire to nearly the minimum — the projectile's time of flight. For example, the commander may want mortars and selected howitzers linked directly with his scouts for immediate responsiveness. Such link-ups must be strictly controlled. The benefits of immediate fire support must be balanced against the benefits we gain from the massing of large numbers of cannon. We must be careful not to forsake the ability to mass fires from all available tubes when needed.

## The Impact on Logistics

The TF CTCP used its available digital capabilities to better execute logistics. IVIS was used to maintain awareness of the TF's current dispositions. B<sup>2</sup>C<sup>2</sup> was used to communicate with the first sergeant. EPLRS was used to send reports to the brigade. Future capabilities will permit an unprecedented level of "precision logistics," permitting efficient distribution and timely support. Automated reports (automatically rolled up by unit) permit logistics staff officers to build an accurate and detailed picture of the status of supported units and supporting assets alike. Linkages between digital systems (such as EPLRS) and the Unit Level Logistics System (ULLS) will permit requisitioning over radio nets rather than physical transfer of disks.

Digital systems will permit improvement in medical support, allowing fast, accurate movement of medics to the correct site (through navigation aids). Digitally-enhanced situational awareness will allow evacuation to the nearest aid station, rather than the unit's own aid station. Digital systems also will permit the use of Television Medicine (TELE-MED), permitting doctors to diagnose patients in the forward battle area, and treat them, through the camera and hands of the combat medic. This capability will permit earlier, better treatment of wounds and will help save soldiers' lives.

## Conclusions

As a partially digitized force executing current doctrine, the ODH VI task force blazed a trail in our attempt to understand future warfighting. It can be said at this point that we have not identified any necessary fundamental changes in our doctrine, but that each new digital system brings with it TTP that alters the way soldiers, leaders, and units fight. Digital battle command systems can allow us to better execute

our current doctrine. Yet, there is undoubtedly a capability for a new way of warfighting. All available, relevant information must be provided to commanders and their units to yield the greatest advantages in lethality, survivability, and tempo. Tactics, techniques, and procedures must address the new capabilities offered by each system (as it is fielded) and work these capabilities into a tactical framework that yields consistent battlefield success. On the basis of ODH VI, this future tactical framework will include:

- Integrated use of digital systems within fundamental warfighting tasks
- Units better able to see the battlefield
- Units better able to identify opportunities for, and create, favorable conditions
- Fighting in extended battlespace
- Use of precision logistics

Properly focused battlefield information permits the precise application of combat power. We must develop an information advantage over the enemy in order to obtain advantages in lethality, survivability, and tempo. At this point, we are at the forward edge of understanding the full impact of digitized systems. Our challenge is to avoid the kind of nearsightedness that obscured the potential of the machine gun prior to World War I, or the tank and airplane after World War I. Our current digital systems represent initial attempts at harnessing information. We must recognize their shortfalls, correct them as they are identified, and work toward objective systems that better harness the power they offer the commander in the future.

Major Jeffrey R. Witsken was the chief of the ODH VI Analysis Cell, directing the analysis and publication of NTC rotation 94-7's results. He is a 1981 Distinguished Military Graduate of Xavier University, and a graduate of AOBC, AOAC, CAS<sup>3</sup>, and CGSC. He has served as a tank platoon leader, support platoon leader, and battalion S4. He commanded D/5-12 Cav, A/3-17 Cav, and served as S3, 3-17 Cav. He is currently an AC/RC advisor, Readiness Group Fort Riley.

# Protect the Force

by Major Michael S. Jacobs and Captain Robert H. Risberg

*Using the versatile Firefinder radars  
As a combat multiplier  
In the offense and defense*

If you have ever trained at one of the Combat Training Centers (CTC) and had your task force's scheme of maneuver interrupted by the devastating effects of OPFOR artillery, you are not alone. The best laid plans cannot succeed if you lose half of your combat power to the enemy's artillery before you even reach the objective. How do you prevent this? How do you protect the force so that it survives to execute your scheme of maneuver?

There is a tool available to the combined arms commander that can help him protect the force from the enemy's artillery. This tool is not a new technology or a new system just coming off the drawing board. This tool is already in our inventory and is found in every division in our army. This tool, the Firefinder radar, can find the enemy's artillery and mortars, respond to the commanders priorities for force protection, and send counterbattery fires missions directly to a friendly firing unit for execution.

## Organization

The Firefinder Radar System consists of the AN/TPQ-37 (Q37) and the AN/TPQ-36 (Q36). These radars are organic assets of every Army division. Heavy divisions have a Target Acquisition Battery (TAB) with two Q37s and three Q36s. Light divisions have a Target Acquisition Detachment (TAD) with two Q37s and have one Q36 organic to each of the division's three direct support (DS) artillery battalions.

The Q37 is a large radar system mounted on three 5-ton trucks. It detects artillery, mortars, and rockets out to a range of 50 kilometers. This radar usually works under the control of the Division Artillery (DIVARTY) commander and concentrates on supporting the division's counterbattery effort.

The Q36 radar is a small radar system currently mounted on two M998s. It detects artillery and mortars to a range of 24 kilometers. This radar usually works under the control of one of the division's DS artillery battalions and concentrates on supporting the maneuver brigade's counterfire effort. This means that the Q36 radar is another asset the maneuver brigade commander has available to help him to protect the force.

## Firefinders Protect the Force

Counterbattery fires can protect the force by silencing enemy guns before their fires can have a significant effect on our friendly maneuver forces. The Firefinder radar's role in this effort is one of *detection*. Firefinder radars detect enemy guns by using radar energy to acquire indirect fires while they are in flight. The radars "see" the projectiles in the air and, through the use of their on-board computer, determine where the round is coming from (target location) and where the round will impact (impact location).

Firefinder's accuracy is good enough to allow friendly forces to shoot back at the enemy's guns and kill them on the first try. Not only is the Firefinder radar accurate, it also "sees" almost everything that penetrates its range fan, including indirect fires, planes, birds, and direct fires. On the plus side, this means that, if your radar is looking in the right direction, it will almost always acquire the enemy fires. On the negative side, this means that the radar acquires an awful lot of stuff flying through the air and can quickly overload the counterfire reporting channels. The radar's computer does screen out anything not acting like indirect fires

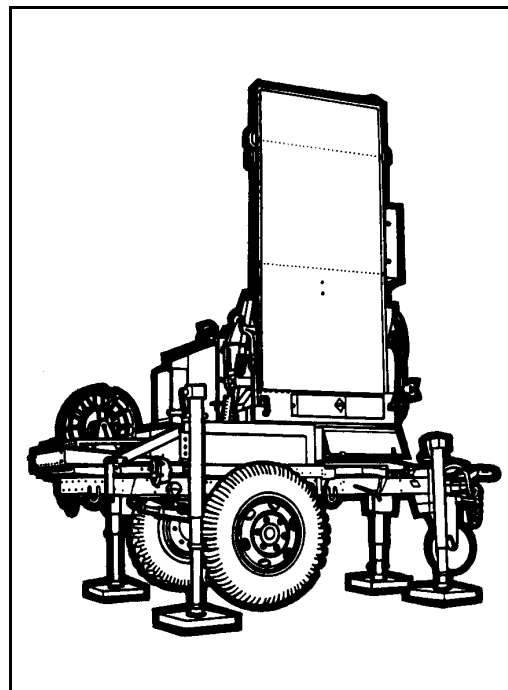

(birds, direct fires, planes etc.), but still reports a very large number of acquisitions. The way the commander screens out everything but what is important to him is through the use of radar zones. Radar zones are the tools the commander uses to prioritize portions of the battlefield that, if influenced by indirect fires, may inhibit the scheme of maneuver. Since the radar acquires all indirect fires within the search fan, a zone tells the radar that any rounds coming from or going to the area covered by the zone are important and reported first. This is key because there are areas on the battlefield that are more important to the commander than others.

Firefinder radars prioritize the battlefield through the use of four zones. Critical Friendly Zones (CFZ), Call For Fire Zones (CFFZ), Artillery Target Intelligence Zones (ATI), and Censor Zones (CZ). Each zone gives the counterfire processing cell different information. CFFZs and ATIs are used mainly by the DIVARTY counterfire planners for the division's counterbattery effort. CZs protect friendly indirect



# FIREFINDER SURVIVABILITY MATRIX

RADAR	SCREENING CREST	TUNNELING	EW THREAT (AIRBORNE THREAT NOT COVERED)	RADAR POSITION HAS SCREENING CREST AND TUNNELING	RADAR POSITION HAS SCREENING CREST ONLY	RADAR POSITION HAS NEITHER SCREENING CREST NOR TUNNELING
WEAPONS-LOCATING RADAR AN/TPQ-36	<ul style="list-style-type: none"> <li>• WITHIN 1,000 METERS OF RADAR POSITION</li> <li>• IN FRIENDLY TERRITORY</li> <li>• FROM 15 TO 30 MILS</li> </ul> ENEMY CANNOT ACHIEVE ELECTRONIC LINE OF SIGHT WITH HIS DIRECTION-FINDING SYSTEMS	USE OF FOLIAGE, BERM, OR BUILDINGS TO REDUCE SIDE-LOBE RADIATION	GROUND EW THREAT	ACCUMULATE 15 OR MORE MINUTES OF RADIATION	ACCUMULATE 8 OR MORE MINUTES OF RADIATION	RADIATE 8 MINUTES MINUS MARCH-ORDER TIME OR 2 MINUTES, WHICHEVER IS GREATER; MAKE SURVIVABILITY MOVE
			REVIEW WITH S2 CURRENT EW THREAT TO FIREFINDER	—but—	—but—	—but—
			NONE	<ul style="list-style-type: none"> <li>• NO EW TIME LIMIT</li> <li>• RADIATE AS MISSION REQUIRES</li> <li>• MONITOR EW SITUATION</li> </ul>		
WEAPONS-LOCATING RADAR AN/TPQ-37	<ul style="list-style-type: none"> <li>• WITHIN 1,000 METERS OF RADAR POSITION</li> <li>• IN FRIENDLY TERRITORY</li> <li>• FROM 5 TO 15 MILS</li> </ul> ENEMY CANNOT ACHIEVE ELECTRONIC LINE OF SIGHT WITH HIS DIRECTION-FINDING SYSTEMS		GROUND EW THREAT	ACCUMULATE 15 OR MORE MINUTES OF RADIATION	ACCUMULATE 8 OR MORE MINUTES OF RADIATION	RADIATE 8 MINUTES MINUS MARCH-ORDER TIME OR 2 MINUTES, WHICHEVER IS GREATER; MAKE SURVIVABILITY MOVE
			REVIEW WITH S2 CURRENT EW THREAT TO FIREFINDER	—but—	—but—	—but—
				<b>DO NOT EXCEED 2 MINUTES OF CONTINUOUS RADIATION</b>		

With command cueing, the radar cues only when indirect fires are impacting on the scheme of maneuver. This limits the time the radar cues, therefore potentially minimizing the number of required moves. A common trend at the CTCs is that this method does work, but that timeliness is a factor. First, a net must be established that the fire supporters can monitor, generally the TF command net, and everyone must know that this is priority traffic.

Scheduled cueing is when a radar cues at specific times for a specific period of time. Use scheduled cueing when you anticipate the beginning of preparatory fires in your area or when, during the heat of the battle, the total number of acquisitions are simply too many to process. An example of a cueing schedule is 20 seconds on and 2 minutes off, continually repeated until told to discontinue.

## CFZ Tactics

CFZs can be a valuable tool for the combined arms commander, but CFZs are not an unlimited radar capability, and must therefore be prioritized. A Firefinder radar can only hold nine total zones in its computer (any combination of the four mentioned earlier) at any given time. This means the commander must use them judiciously throughout the brigade sector. The brigade commander may allocate zones to his task forces for planning, but all of these zones cannot be in effect at the same time.

Though a restriction, this does not stop you from planning CFZs throughout your entire scheme of maneuver.

Plan CFZs in a similar fashion as targets, top-down. The direct support artillery battalion commander, as the brigade's fire support coordinator (FSCO-ORD), and the brigade fire support officer (FSO) know how the brigade commander wants to fight the battle and should plan CFZs on those critical areas where enemy indirect fires may influence his fight. And as in top-down

fire assets from being reported as acquisitions by friendly radars. The zone that is most important to the combined arms commander, from CO/TM through brigade, is the CFZ.

## CFZ Definition

According to FM 6-121, *Tactics, Techniques, and Procedures for Artillery Target Acquisition*, a CFZ "is an area, usually a friendly unit or location, that the maneuver commander designates as critical. It is used to protect an asset whose loss would seriously jeopardize the mission." In other words, a CFZ is an area around somewhere, someone, or something the commander thinks is critical to his operation and must be protected from enemy indirect fires. When a radar predicts that a round is going to impact inside a CFZ, the location of the weapon firing into the CFZ is immediately designated as a priority one acquisition and a digital call for fire is transmitted to the coun-

terfire controlling headquarters or directly to a friendly firing unit. This in turn is immediately sent down to a fire unit for processing and execution. The effect is responsive counterbattery fires for the brigade.

## Radar Technical Considerations

It is necessary to discuss some of the technical considerations of the system before we discuss some employment techniques.

The Firefinder radar only acquires targets when it is radiating, or cueing. Two methods exist for ensuring the radar is cueing at the appropriate time: command and scheduled cueing.

One key tactical consideration of the radar is that the survivability flow chart in FM 6-121 clearly states that the radar should not cue for more than 15 minutes total or 2 minutes continuous from any given position. Because of this, the two methods of cueing were developed.

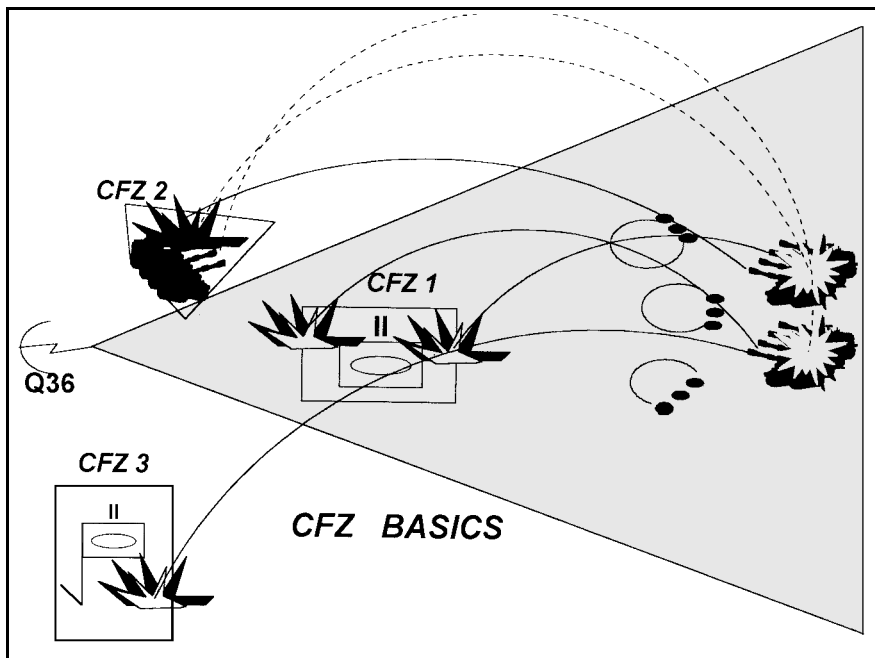

fire planning, allocate a number of zones to each task force for planning. Task force commanders and their FSOs plan the zones to support their scheme of maneuver. The brigade FSO then looks at what the task forces want, resolves any conflicts and or duplications, prioritizes the zones for the entire brigade, and finally issues the brigade zone plan to all fire supporters within the brigade (including the COLTS), the counterfire headquarters, the DS battalion, and the radars.

Another of the great things about a CFZ is that it does not have to be within the radar's search fan. This capability allows for any unit behind the radar, such as TOCs and trains, to have full coverage.

A technique used very effectively at the CTCs is battle tracking with CFZs. As the battle progresses and the FLOT moves forward, delete CFZs that do not have any purpose and implement ones that will. In a fluid battlefield, this must occur if zones are to be used effectively.

### Offensive Techniques

In the offense, plan CFZs to protect the force throughout the scheme of maneuver. Published doctrine emphasizes using CFZs for the protection of command posts, combat trains locations, passage lanes, and scouts.

These assets are fine if they are the most critical to the operation and the

commander prioritizes them. Consider two areas in an offensive operation where CFZs may be more useful: breach sites and support and attack by fire positions.

The OPFOR at the CTCs do a great job of keeping obstacles covered by forward observers. The observers have simple instructions — if a unit attempts to breach the obstacle, call for indirect fires. It is common at the CTCs to see a task force lose 50 percent of its combat power at an obstacle to indirect fires. Because a breach site is such a critical area on the battlefield for the commander, establish a CFZ around the area where the breach will occur. By doing this, you've prioritized this area on the battlefield and any indirect fires, lethal or non-lethal, will be prioritized for counterbattery execution. Plan CFZs on obstacles you plan to breach as well as establish CFZs on obstacles that you were not aware of, but must breach.

The next critical area on the battlefield that is commonly not considered for a CFZ, but may greatly influence the outcome of a battle, is the support or assault by fire position (SBF or ABF).

If the supporting or assaulting force cannot effectively direct its fires because of enemy indirect fires, synchronization is not achieved. A CFZ around the SBF or ABF position can keep enemy indirect fires from interfering with the supporting/assaulting force's mission.

In both of these examples, we have prioritized, through the use of a CFZ, the counterfire fight for the counterfire headquarters. We have told them, with the nomination of these zones, that if these areas become saturated with indirect fires, it will affect the accomplishment of the mission. Therefore, the firing units affecting these areas, regardless of the type of munition being fired, will be addressed first.

### Movement to Contact/Meeting Engagement Techniques

In a movement to contact/meeting engagement, the area most likely to receive enemy indirect fires first is where the combat reconnaissance patrol (CRP) meets our scouts or the forward security element (FSE) makes contact with our lead company/team (CO/TM). In either case, establishing a CFZ around our forces, protects them from

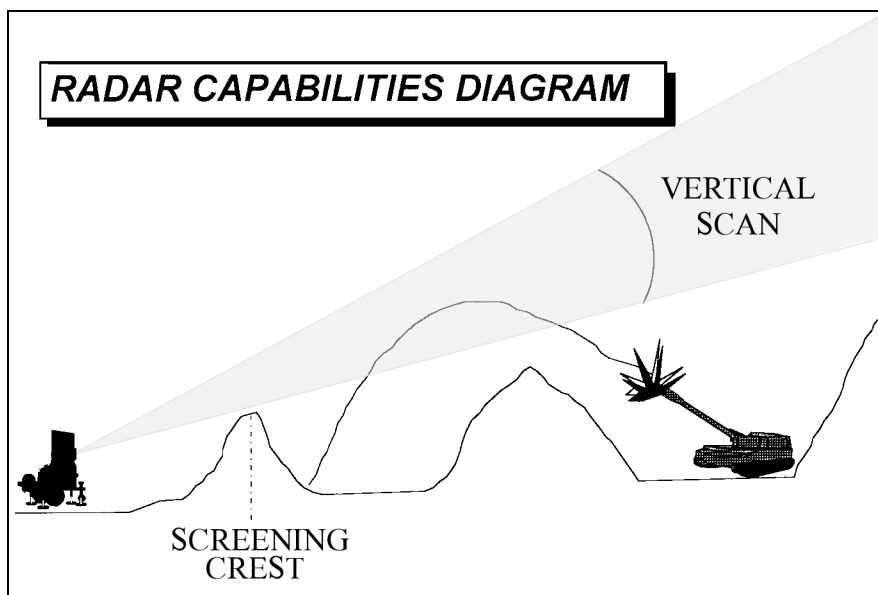

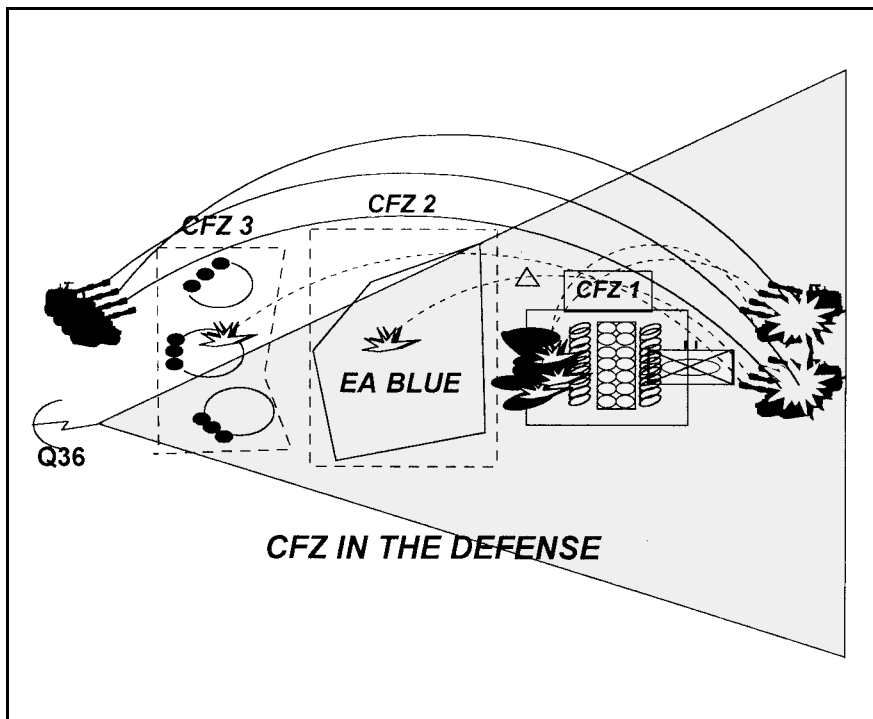
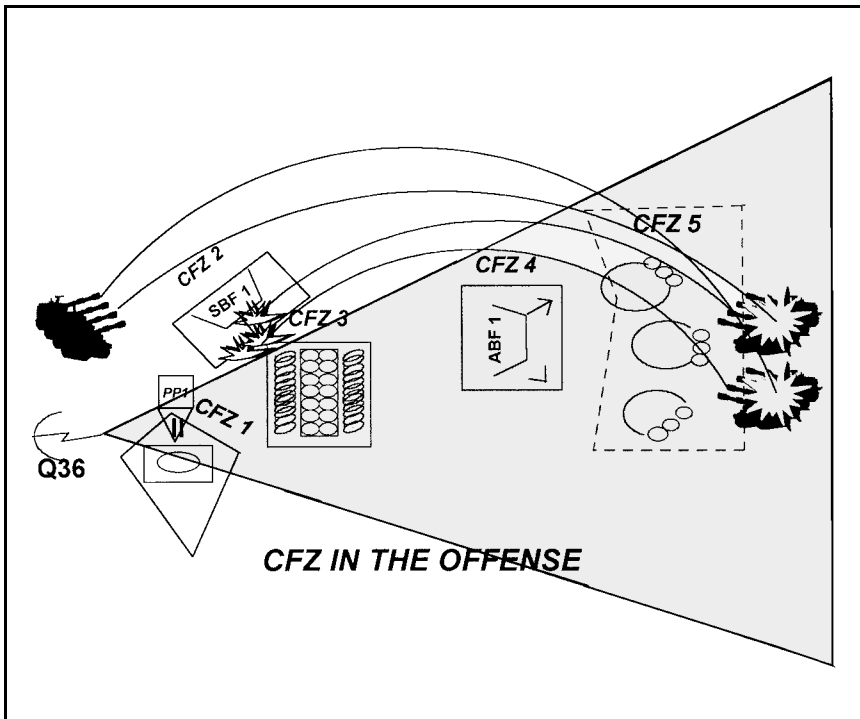

the effects of indirect fire and allows direct fire engagements to take place with greater effect. The other area most likely to receive influential indirect fires is where the task force commander sets a CO/TM in order to fix the enemy main body. Here we establish CFZs to protect our fixing force

and again allow for more effective engagements and maneuver.

### Defense

In the defense, the areas that warrant protection from indirect fires are friendly

obstacles, engagement areas (EA), and the areas forward and on the battle position (BP).

When an attacking enemy force runs into our obstacles, he does the same thing we do — he either maneuvers around it or begins to breach. If he breaches, he uses indirect fires on the far end of the obstacle (our side), to screen his forces and he suppresses or neutralizes the friendly forces overwatching the obstacle. A CFZ planned around our force overwatching the obstacle, and around the area the enemy would place screening fires, allows us to quickly silence his guns delivering the fires and deprive his breaching force of those obscuration fires. If we deny him covering fires, he is extremely vulnerable to our direct and indirect fires.

A proven technique is establishing a CFZ on the battle positions surrounding the EA. When he finds himself in our EA, he will focus his indirect fire on our direct fire systems. With the CFZ in place, these units become priority for counter fires.

### Rehearsals

Any plan or operation has a better chance of success if it is thoroughly rehearsed, and this is also true of the counterfire/counterbattery plan.

The technique of battle tracking with zones is a prime example. As we discussed earlier, the radar computer holds nine total zones. Because of this limitation, we must decisively activate and deactivate zones as the operation proceeds. The radar crew and the counterfire headquarters must be a key component of a rehearsal, arguably both the combined arms rehearsal and the fire support rehearsal. During the rehearsal, exercise the system for getting the right zones in effect in the right places at the right times. The rehearsal is the key to integrating ALL parts of the plan.

### Conclusion

The Firefinder radar is an asset available to the combined arms commander to assist him in protecting his forces. It cannot protect kk his forces all the time from indirect fires. If properly employed, it can greatly reduce the enemy's ability to effectively use indirect fires against us. Commanders at all levels must understand the capabilities of

the Firefinder radar and, more importantly, include it in your guidance to your Fire Supporter.

Please note that these are not the only techniques of establishing CFZs throughout the battlefield. But the bottom line is that Firefinder radar can help us protect the force and keep soldiers alive on the battlefield.

Major Michael S. Jacobs is currently assigned as the Chief, Field Artillery, 4th Squadron, 16th Cavalry Regiment, U.S. Army Armor Center. His previous assignment was as the MLRS/Radar Observer/Controller, Combat Maneuver Training Center (CMTC), Hohenfels, Germany. Other assignments include: commander, A Btry, 6th Battalion, 29th FA (MLRS), 1st AD, Germany; S2, 2d Battalion, 1st FA, 1st AD, Germany and during DESERT STORM; FSO, 1st Squadron, 9th Cavalry Regiment, FSO, 268 Attack Helicopter Battalion, executive and platoon leader, C Battery and battalion motor officer, 1st Battalion, 84th FA, 9th ID, Ft. Lewis, Wash.; Maintenance and Assembly Team leader, 558th USAFAD, Drama, Greece.

Captain Robert H. Risberg is currently an Active Component to Reserve Component operations officer with 1st Brigade, 78th Division (Exercise) in Edison N.J. His previous assignment was as the Field Artillery Battalion S3/S2 Observer/Controller, Combat Maneuver Training Center (CMTC), Hohenfels, Germany. Other assignments include: commander Battery B, 25th FA (TA), 3d ID, Germany; Division Artillery Fire Direction Officer, 3d AD, Germany and during Desert Storm; battalion FSO, battalion S4, and firing battery XO, 1st Battalion, 29th FA, 4th ID, Fort Carson, Colo.; and battery fire direction officer and company FSO, 1st Battalion, 15th FA, 2d ID, Korea.

## Two Stakes in Tandem Help Eliminate Danger Of Falling Antennas

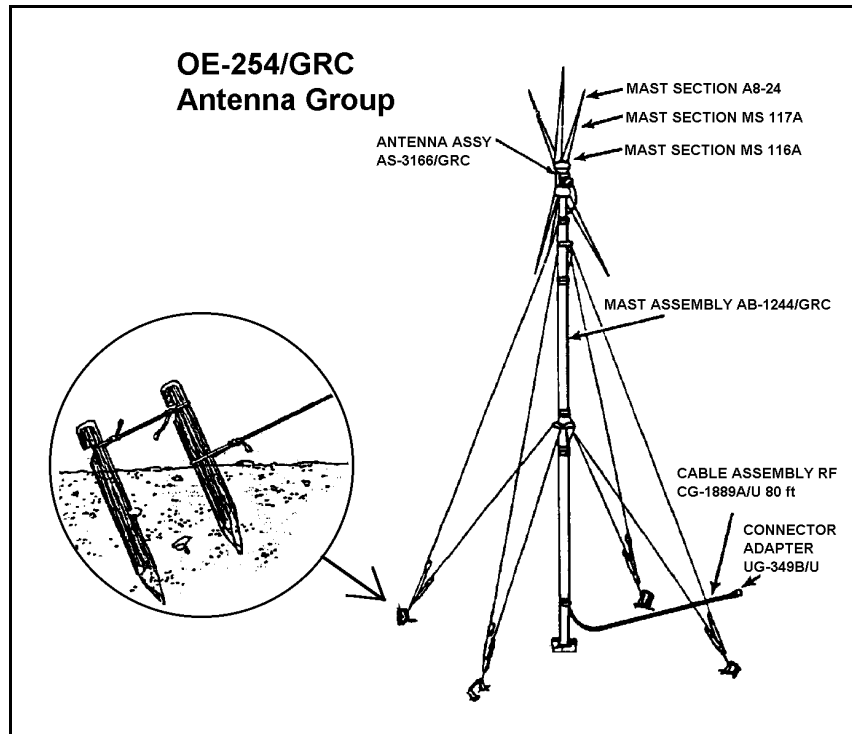

By driving in two stakes and tying them in tandem, as shown in the circled portion of the illustration above, chances of a stake working loose in high winds or soft ground can be greatly reduced, writes LTC David M. Fiedler, from Fort Monmouth, N.J.

“Over the last 15 years, I have personally seen several antenna assemblies come loose and fall on personnel. These assemblies were primarily OE-254-type antennas, but I have also seen RC-292, OE-303, and other antennas commonly used by combat units do the same thing,” he said. “The primary cause of the antenna assembly collapse was that they were erected in very soft ground, such as sand or loose shale, and the support stakes just couldn’t hold against the forces pulling against them, even in slight winds. Tactically, the equipment operators had no choice in the location of the antennas...they were doing the best they could from the site selection point of view.

“Since the masts involved were over 30 feet high and the weight of the antenna was near the top, it doesn’t take much to work the support stakes loose.”

LTC Fiedler said he had used this method many times, beginning back in the Vietnam War, and most recently with the New Jersey National Guard at Fort Dix, N.J. The method has proved 100-percent successful, he said, in eliminating a problem that has injured many soldiers and resulted in the loss of much expensive equipment.

# Training in a Low Budget Environment

by Major Armor D. Brown, Major Clarence E. Taylor, and Major Robert R. Leonard

*"The bodies of men, munition, and money may justly be called the sinews of war."*

— Sir Walter Raleigh

**Introduction.** Money has been a critical component both of armies and of the art of war since before the hoplites of Alexander's days. He may lack the glory of the field commander, but the comptroller in today's modern military establishments wields a mighty weapon on the field of battle, and more importantly, in the training that precedes war. This article will offer some insights and tips into training in the context of a low budget environment. Even with a constrained budget, it is possible to train effectively if the leaders know how to squeeze every bit of training value from each dollar.

Recently, our brigade combat team returned from a highly successful rotation at the National Training Center. We purchased our successes at the NTC during the six months of intensive train-up that preceded the rotation. The challenges we faced were severe, since the brigade suffered approximately a 30 percent budget cut from the previous training year. What follows are some of the lessons we learned about training for a Combat Training Center (CTC) rotation with limited resources.

What is a successful rotation? Although such a claim must be largely subjective, we believe our training at the NTC in December 1994 was successful from several aspects. We maintained a good record in the vital areas of safety and accountability throughout the rotation. We experienced solid improvement from mission to mission. At the same time, our initial training level was high in the opinion of the observer-controllers (OCs). We beat or drew against the OPFOR most of the time. Finally, we demonstrated strengths in the key areas of tactical decision making processes (TDMP), live fire, company/team tactical movements, casualty evacuation (CASEVAC), planning and execution of the brigade deep battle, and soldier/crew preparation. Of

course, we were not perfect by a large measure. As might be expected, the professionals at the NTC dissected us on the field of battle and showed us many areas that needed improvement. Still, both the trainers and the brigade's leaders and soldiers agreed that the brigade arrived prepared to train and departed ready for war...despite a tight budget.

As we thought about that preparation, we distilled several key themes in our train-up that led directly to our successes in the desert. Among those themes are:

- Starting with a clear assessment and commander's guidance
- Use of simulations
- Use of a graduated plan of field training
- Gunnery innovations
- Integration of all battlefield operating systems (BOSSs)
- Emphasis on leader training
- Focus on the basics
- Use of money-saving training techniques

**Clear assessment and commander's guidance.** The brigade combat team (BCT) had one enormous advantage going into the train-up period: the BCT had just completed an NTC rotation in January 1994. Since most of the key leaders for the second rotation were still with their units — indeed, quite a few were still in the same job position — we had a lot of collective experience that we could draw on. More importantly, the commanders had a clear vision of our areas that needed improvement from the first rotation.

While the January rotation was a successful one, the brigade combat team left Fort Irwin with a solid plan for improving performance. Specifically, we wanted to improve on intelligence preparation of the battlefield (IPB); wargaming; reconnaissance, surveillance, and security (RSS) planning and execution; company/team operations orders (OPORDs); preparation for combat; direct fire planning; and integration of indirect fires.

As we approached the train-up period, which began in earnest in August, 1994, the commanders at each level established clear, simple intents for training. Further, commanders at each level were careful to assimilate and expand upon the higher commander's intent. Hence, as we began the train-up, the leaders and soldiers were guided by solid commander's intent statements that were nested and enforced at each level.

The other factor that served the BCT well was the decision to task-organize early. The teams of officers, NCOs, and soldiers that would prevail in the cold December desert began to form and develop both written and unwritten SOPs in late July. Of course, complete task organization is a challenging and elusive goal, but the commanders made the necessary sacrifices in the interest of team-building, with the result that the rotational units enjoyed four months of association in garrison and in the field prior to deployment.

**Simulations.** One of the most obvious ways to save money in today's training environment is through the use of simulations. Modern technology permits leader, collective, and individual training with simulations to an unprecedented degree. But no machinery, however artfully designed, replaces good planning or imaginative training management. Hence, the key to the effective use of simulations is thorough planning, and a broad vision for exploiting all the potential of computer-based and terrain-board simulations.

Our brigade used both the JANUS computer-based simulation and a terrain-board system known as Fire Command Plus. JANUS is a computer model used in both combat developments and training. A professional OPFOR plans and executes the enemy operation, and after the battle, the simulation can replay the battle for instruction, focusing on the critical aspects of the fight. The BCT used JANUS at brigade, task force, and company level to develop and train brigade deep battle procedures (especially RSS), as well as

---

our close battle operations. We were able to refine our TDMP, reporting procedures, and fire planning (both direct and indirect). We also improved our knowledge of the terrain we were going to fight on by using digitized NTC terrain.

Fire Command Plus is a wargaming system that employs micro-armor maneuvering across a terrain board that (in our case) portrayed the National Training Center. Again, a dedicated, professional OPFOR provides an uncooperative and free-thinking enemy. The BCT used Fire Command Plus to train from company/team through brigade level in TDMP, maneuver and BOS integration. We used lessons learned to develop and train brigade and battalion SOPs. Finally, we employed Fire Command Plus as the simulation tool for a five-day logistical exercise (LOGEX) that helped us to train on all aspects of combat service support (CSS).

Simulations did not adequately address all of our training objectives. One of our lessons learned during the rotation was that our combat vehicle crews needed more training on terrain driving and the use of terrain in combat. We could have benefited from the use of SIMNET, a training simulation that uses a network of computer-simulated combat vehicle stations to train crews. Our use of simulations, however, did allow us to get more out of our field training dollars.

**Graduated field training.** Simulations can accomplish only a portion of the training required to prepare a unit for a CTC rotation (or for war). Field training is still essential in order to allow the leaders and soldiers to maneuver under real conditions. Unfortunately, field training is among the most expensive training a unit can conduct, so leaders will almost always face budget constraints when planning it. Our brigade was funded and resourced with the time to conduct only two major field training exercises, each approximately two weeks long.

Instead of allowing our maneuver platoons to simply charge out to the maneuver area in order to learn how to maneuver, the brigade ensured that leaders were proficient in basic tactical and maneuver skills prior to conducting lane training. We accomplished this by developing a ten-day training plan based on the crawl, walk, run approach that ensured the platoon leaders and company commanders would use the

scarce maneuver time and resources to optimal advantage.

We started with our commanders instructing the platoon leaders on fundamental individual and collective tasks derived from the MTP and field manuals. Initial training consisted of classroom instruction on topics such as troop leading procedures according to our current doctrine, and tactics, techniques and procedures (TTPs). Seminars often transitioned into a sharing of TTPs that worked well at Fort Hood and the NTC. These classes culminated with the platoon leaders and tank commanders receiving an order and then conducting a movement to contact on a terrain board, evaluated by the battalion executive officer and S3 Air. We derived this training model from the Armor Officer Basic and Advanced Courses.

Platoon leaders practiced movement techniques on a parade field. Combat vehicle crews practiced basic crew and platoon drills by walking across the field, simulating various vehicle maneuvers, and communicating with backpacked radios. The company commanders evaluated the maneuvers, ensuring each unit performed to standard. After demonstrating proficiency on the parade field, the platoons moved out to the maneuver area to conduct dismounted platoon training. We conducted tank platoon dismounted training at a centralized location using a series of dismounted lanes. The company commanders issued their platoons an order on the ground on which they would conduct their mission. The commanders then evaluated them on both offensive and defensive missions.

Mounted field training began in August. The intent during the development of our train-up plan was to resource and execute platoon situational training exercises (STXs), or "platoon lanes." Unfortunately, we soon discovered that we did not have adequate time and money to conduct platoon, company/team, and task force lanes, and we decided to resource the last two. As a result, we missed the opportunity to focus our training on platoon-, squad- and crew-level field training. Our decision was correct, but failure to provide field training at the lowest level resulted in a noticeable lack of field craft at the soldier/crew/squad/platoon level. Specifically, our platoons had to struggle to catch up on battle drills and tactical movement techniques. Our assembly area procedures

and tactical road marching suffered as well from our inability to train the basics at the lowest level. If we were to do it all again, we would resource mounted platoon-level battle drill training at the expense of a few days of training at the higher levels.

Our company/team lanes included some of the most effective training we conducted. Consisting of a series of STXs, the lane training included movement to contact (MTC), deliberate attack (DATK), defense in sector (DIS), counterreconnaissance screening, and a counterattack (CATK). The companies rotated from one lane to the next according to a schedule that approximated the difficult pace of NTC operations. Our non-rotational armor battalion was a full partner in the train-up. They provided a professional, challenging OPFOR against our rotational company teams, as well as a full OC package down to platoon level. Fully equipped with MILES, the training companies and the OPFOR clashed in hard-fought battles that quickly improved our company/teams' readiness over the course of a few days.

We had to manage our funds very carefully, because we conducted the lane training near the end of the fiscal year. Facing serious budget challenges, the BCT considered several strategies for conducting task force lanes. We chose a plan that provided each battalion task force about one week of training, opposed throughout by the non-rotational armor battalion. We considered the lanes to be a graduation exercise for the platoons and companies, and we employed all of the battlefield operating systems during the training. For example, during the defensive lane, engineers dug fighting positions to standard, and both engineer and field artillery participated in offensive operations.

Each battalion task force conducted a defense and two attacks (one day, one night). As with the company lanes, the task force lanes included a complete package of OCs and a system of thorough after-action reviews (AARs) at each level of command. The BCT battle staff conducted numerous orders drills throughout both exercises and produced orders that we subsequently used and evaluated, enhancing their ability to plan and execute both close and deep operations.

**Gunnery innovations.** Following our force-on-force training, the BCT con-

---

ducted a gunnery density. The two rotational battalions performed a gunnery density through Table XII and a combined arms live fire exercise (CALFEX), while the non-rotational battalion performed gunnery through Table VIII. Again, the BCT commander faced challenging budget constraints. Normally, each battalion would be resourced to conduct platoon gunnery up through Table XII (platoon qualification), followed by a CALFEX at company/team level. In our case, however, there was sufficient time, range availability, and money for either a Table XII or a CALFEX. Hence, the commanders had to decide which level of training was more important.

Again, the principle of basing training on accurate assessment came into play. The infantry battalion commander deduced that his Bradley platoons required the focus of platoon qualification to integrate mounted and dismounted operations. The armor battalion commander, however, opted for a CALFEX, because most of his platoons had completed a Table XII during the leaders' tenure. Both strategies paid off well, because the commanders and staffs developed combined arms, multi-echelon approaches to the live fire exercises.

The infantry battalion's Table XII featured a robust dismounted portion to complement the mounted gunnery and maneuver. The qualification run included a helicopter movement and a long foot patrol. The day live fire included an antiarmor ambush, several mounted engagements, trench line clearing, and a defense against counter-attack. The night phase of the Table XII comprised a dismounted, non-illuminated, unsupported night attack on an enemy hasty defense, followed by rapid reinforcement by the mounted element during consolidation. The emphasis throughout was upon fire planning and integration of mounted and dismounted operations.

The armor battalion conducted a CALFEX in lieu of a Table XII. The CALFEX focused on company team maneuver and fire support. Each company team was evaluated on assembly area procedures and tactical decision-making. The team then maneuvered through a live-fire breach conducted by the engineers and then onto the actual CALFEX range. Along with tank and Bradley platoon fire and maneuver, each company team practiced employment of fire support from mortars, artil-

lery, and close air support. The tank battalion task force proved the efficacy of their train-up when they successfully killed every target during the night live fire defense at the NTC!

The success of the brigade's combat vehicle crews was underpinned by thorough preparation of the leaders prior to gunnery. The leaders practiced fire planning and engagement area development on the gunnery ranges. During crew practice and qualification, the crews that were waiting to fire completed comprehensive concurrent training on casualty evacuation, storing and arming antitank mines, preparing sector sketches, and other critical tasks.

**BOS integration.** One of the keys to success in both training strategies was the integration of combined arms capabilities. Our combat engineers conducted both obstacle construction and breaching, including several live-fire breaches. They also dug several trench lines in support of our infantry. The fire supporters conducted numerous indirect fire missions in support of the maneuver, including close air support, on both the Table XII and the CALFEX. In each exercise, as with our lane training, the BCT leaders insisted upon multi-echelon, combined arms training and the full integration of all BOSs.

Another major key to the BCT's success at the NTC was the concept of logistical support. After receiving the brigade commander's intent, the FSB commander, in close coordination with the brigade XO, developed a plan to ensure that the CSS system was fully synchronized with the BCT's scheme of maneuver prior to and during the NTC rotation. The plan was to ensure that the CSS system was tested and validated prior to the NTC rotation. Our senior logistical operators conducted a logistics reconnaissance (log recon) at NTC in August. The purpose was to plan the draw and turn-in operations, as well as the concept of support for field maneuver. CSS operators briefed their concept of support to the maneuver battalions shortly after returning from the log recon and then tested it during the lane training. This concept of support was validated during the forward support battalion's LOGEX. The LOGEX was a five-day exercise that included all CSS operators and planners and used a combination of CSS classes and our simulation center terrain boards to practice specific logistical procedures for three missions:

movement to contact, deliberate attack, and defense in sector. All BCT CSS operators participated in the LOGEX, and one of the most important results was the team-building among the major players from the FSB and the maneuver battalions. For example, when the players arrayed the maneuver battalions and FSB assets on the terrain board, it became apparent to all that the battlefield clutter arrayed before them demanded detailed, collective terrain management from all staff sections in the BCT. We also identified the management of engineer barrier material as a shortfall during the LOGEX, and we developed an SOP on the management of the forward supply point that was coordinated with all players from the LOGEX.

One of the BCT's conspicuous strengths during the rotation was casualty evacuation — a difficult collective skill to develop. Our success was made possible by a constant emphasis on the task. At no point in our train-up did we permit ourselves to "hand-wave" casualty evacuation. The BCT's command sergeants major closely supervised CASEVAC during each battle and evaluated our aid stations each field problem. By the time our units completed task force lanes, CASEVAC was a natural part of our tactical rhythm. Further, we refined our techniques through a series of three health services seminars led by the brigade S1, the chief of the division medical operations center, and the commander of the FSB's medical company, during which our company first sergeants, XOs, and medical personnel developed better and faster ways of recovering and treating casualties.

The fire support BOS was another area of obvious success at the NTC. Throughout our train-up, maneuver and fire support leaders planned, trained, and operated together. We integrated the O&I Battalion commander and staff early in our training. The fire supporters ensured a continuous emphasis upon the "maneuver-shooter" concept — i.e., maneuver leaders calling for and adjusting indirect fires. They also performed comprehensive fire support rehearsals prior to each operation, and they included the maneuver battalion commanders and S3s to ensure understanding of the plan.

The combat engineers were also energetic in their integration of mobility, countermobility, and survivability training into the BCT plan. Again, our lead-

---

ers resisted the temptation of “hand-waving” the difficult art of obstacle construction and breaching. Instead, every operation during company/team and task force lanes integrated this key BOS into the mission.

### **2AD Training Model**

- **Plan the training**
- **Teach leaders doctrine, tactics, techniques**
- **Recon training site**
- **Issue the OPORD**
- **Rehearse the plan**
- **Conduct the training**
- **After action review**
- **Retrain**

Building an effective combined arms team remains a difficult art, and we experienced some training deficiencies in BOS integration. Among our areas for improvement were our training with the chemical company, communications, employment of air defense artillery, integration of the military police, and some aspects of our CSS. Our interface with the chemical company and the transition from a battle position to a decon link-up needed work. Our communications problems involved our Maneuver Control System (MCS) and tactical fax capabilities. We experienced some degradation in command and control, because we had not thoroughly trained on those systems. Our MPs performed well at the NTC, but during the train-up, they were frequently distracted by garrison duties and unable to fully participate with the BCT. The CSS challenge was to enforce a break with day-to-day garrison operations and instead transition fully to field conditions for combat service support. Finally, we were unable to train with our air defense artillery, because they were deployed on a real-world mission during train-up.

**Emphasis on leader training.** Army training doctrine emphasizes the importance of leader training. The 2nd Armored Division employs a training methodology that focuses on this critical step in unit training. As an example of this approach, BCT platoon, company, and task force leaders conducted extensive tactical exercises without troops (TEWTs), learning the steps of building an engagement area.

BCT leaders also benefited from the after-action reviews from the previous

rotation. The brigade commander required all battalion commanders to write synopses of their take-home packages. Commanders collectively reviewed the video tapes of each mission from the earlier rotation. As the brigade senior leaders progressed from tape to tape, the brigade command team developed a common agreement on how to fight each brigade mission and what each unit would bring to the fight. At the end of each session, the leaders distilled that understanding into written command guidance. Thus, throughout the train-up, the brigade command team developed a common vision of the purpose, method, and end state for each type of mission. It is this implicit, shared understanding of the commander’s intent that energized our decentralized operations on the fast-paced battlefield at Fort Irwin.

The BCT’s officers and NCOs also pursued an ambitious OPD/NCOPD program during the months before deployment. We used those sessions to focus on the complexities of some of our more difficult operations, such as passages of lines, and the draw/turn-in weeks. The professional development classes served as forums for the instruction of the new members of the team, and the pooling of the insights and ideas of the more experienced leaders.

We were also fortunate in having the opportunity to participate in FORSCOM’s Leader Training Program (LTP) at Fort Irwin. The operations group at NTC have developed LTP into a rigorous week-long exercise that provides leaders the opportunity to view the Fort Irwin terrain, receive instruction on doctrine and TTPs. The BCT conducted two orders drills, one of which was then followed with a JANUS simulation of the planned operation, followed by a complete AAR. One of the most valuable aspects of the program was that the OCs provided specific feedback to the BCT’s battle staffs and commanders, which helped to establish good communications and rapport among OCs and the training units. Our brigade was the pilot unit for the revised program, and we were permitted to take 34 of our leaders to participate. Since then, the program has been expanded to twice that number. The LTP experience helped the brigade’s commanders and battle staffs acquaint themselves with the rigorous pace of NTC tactical decision making.

Finally, we must mention a more intangible part of leader preparation: learning attitude. From the start of our train-up, the entire chain of command cultivated an attitude of learning throughout all levels. We conducted after-action reviews with complete candor, and commanders led by example in avoiding defensive attitudes and showing an enthusiasm for learning. This is an important skill to develop, because CTCs are all about learning. Regardless of a unit’s entry training level, we must ultimately judge its success in terms of how that unit improved. Such improvement depends on the training unit’s ability to assimilate lessons learned and, to a large degree, on the rapport established between the observer-controllers and the training unit. In our case, our leaders and soldiers deployed to NTC ready to learn and improve.

**The basics.** As noted at the beginning of this article, our brigade combat team anchored training on the basics. In our case, the basics included uniform and safety discipline, MILES gunnery, knowledge of OPFOR weapons and tactics, and maintenance. One of our innovations in our train-up was our NTC Individual Skills Test. The test included only those soldier and leader tasks that the commander deemed especially critical. Specifically, the testing stations included rules of engagement (ROE), MILES skills, risk assessment, OPFOR knowledge, BCT “ground rules” (i.e., brigade SOPs on uniform and discipline) and a station on the NTC scenario. We provided the test (with all answers) to the companies in enough time to allow company commanders to train their soldiers. The actual test took two days and featured well rehearsed, streamlined, mostly hands-on testing of the critical skills in a manner similar to the Expert Infantryman Badge test. Every officer, NCO, and soldier in the tested units had to pass the test prior to deployment, and the test was stratified into senior leader (SFC and above), junior leader (SGT, SSG), and soldier tasks.

Probably the most important skill to develop in order to build lethal units at NTC is MILES gunnery. The BCT’s officers and NCOs emphasized MILES skills throughout the train-up period. We took advantage of special MILES “train the trainer” certification classes conducted by the post’s MILES contractor. The contractor — a skilled



trainer and an expert in all aspects of MILES equipment — conducted both classroom instruction and a rigorous hands-on certification with selected NCOs from each battalion. He debunked many of the MILES myths that accompany unfamiliarity with the system, and he trained our sergeants in the finer points of zeroing the laser systems. Additionally, the contractor attended most of our field training during company and task force lanes, personally verifying each combat vehicle system and coaching our NCOs along the way. After receiving instruction, our crews were then evaluated on their ability to use MILES by conducting a MILES gunnery skills test (MGST). The MGST, which we developed in a manner similar to tank and Bradley gunnery skills tests, consisted of five stations: inspection of the MILES kit, vehicle installation, boresighting, zeroing, and troubleshooting the system.

**TTPs on saving money.** There are some techniques that units facing similar budget constraints can follow. To begin with, it is imperative to base all training on assessments so as not to waste resources. The leaders must be flexible enough to allow subordinate units to vary their training to meet each unit's unique needs.

All training should be structured to allow the different echelons of command to train simultaneously, and each BOS to participate fully. The division commander improved the effectiveness of our training by insisting on complete synchronization of unit training plans. For example, he rescheduled a field artillery live fire in order to make it concurrent and integrated with the maneuver battalions' live fire exercises. We ensured our gunnery plan transcended the standard gunnery tables and instead enhanced the advanced gunnery tables into full combined arms training events. While the companies maneuvered in the field, the battle staffs conducted orders drills and battle tracking. The key to success is teamwork, and teamwork requires practice. It is not a natural skill!

We tried to structure the training events so that we trained only the critical skills. In our case, we reduced movement distances, for example, in order to preserve time, fuel, and repair parts for the important combat tasks. We ensured the use of diagnostics to reduce the number of replaced major components. To save costs, the BCT

employed heavy equipment transporters (HETs) to hold down operating costs.

Finally, leaders at all levels must be flexible — willing to monitor costs and adjust training plans accordingly. Depending on resourcing constraints, equipment failures, and fluctuating turn-in credits for repair parts, it can be nearly impossible to foresee the actual costs of each training event. Therefore, the leaders must be prepared to alter the training plan on short notice — even during execution.

**Conclusion.** Good leaders are preoccupied with training, because history has taught us that the best way to care for soldiers is to train them for war. Nevertheless, we can anticipate that at no time will leaders be free from budgetary constraints on training. Developing innovative ways to train effectively with few resources is a vital tool for all leaders. In this article, we have offered some of the training tips we developed during a challenging train-up for the National Training Center. Maximum efficiency begins with an incisive assessment, a clear vision from the commander, and a comprehensive but flexible training plan. It is imperative to exploit available resources by choosing what to train and what not to train. Rather than trying to “do more with less,” our commanders made the tough choices and trained fewer tasks to the proper standard.

An artful combination of simulation, force-on-force training, and gunnery can overcome the budget challenge. Insistence on combined arms, multi-echelon training, combined with a focus on leader development can help to squeeze every bit of training value from each dollar. Finally, it is essential that a unit's preparations for a CTC rotation or for war are grounded in training the basics of moving, shooting, and communicating.

The payoff for resource-efficient training goes beyond having a successful rotation. Good training results in units and soldiers that believe in themselves and their ability to win in war. Although there are realistic limitations on our ability to “do more with less,” there are also endless opportunities to innovate and overcome the challenges. In the end, a low-budget training environment brings to light the adage that the will to win is not as important as the will to *prepare* to win.

Major Armor D. Brown was commissioned in 1980 through the Officer Candidate School and attended AOBC, Airborne School, Ranger School, IOAC, CAS<sup>3</sup>, CGSC, and SAMS. He served as a tank platoon leader, scout platoon leader, and battalion S4 in the 1st ID. He also served as a small group instructor at Fort Knox. He commanded C/2-66 Armor and HHC/2-66 Armor. Subsequent assignments included G3 Training in the 2d AD. He is currently assigned as the battalion XO in 1-67 Armor.

Major Clarence E. Taylor is a 1979 graduate of the U.S. Military Academy. A graduate of AOBC, AOAC, CAS<sup>3</sup>, CGSC, and SAMS, he has served as a tank platoon leader, support platoon leader and battalion S3 Air. He has commanded B/4-40 Armor, HHC/4-40 Armor and served as a battalion S3. Subsequent assignments include operations officer, DCSOPS, Fifth Army; United Nations Military Observer, Jerusalem, Israel; and G3 Plans Officer, 2d AD. He is currently assigned as battalion XO, 3-67 Armor, Fort Hood, Texas.

Major Robert R. Leonhard was educated at Valley Forge Military Junior College and Columbus College, where he received a BA in history. He also has an MS in International Relations from Troy State University, and a Master of Military Arts and Science from CGSC. He attended IOBC, IOAC, Airborne School, CAS<sup>3</sup>, CGSC, and SAMS. He commanded C/1-6 Infantry in Germany and is currently the S3 for 1st Battalion (Mechanized), 41st Infantry at Fort Hood, Texas. He is the author of *The Art of Maneuver: maneuver warfare theory and AirLand Battle* (Presidio Press, 1991), and *Fighting by Minutes: time and the art of war* (Greenwood Press, 1994).

# A Mini Tank Range, Step by Step

by Captain Gregory M. Parrish

*“Bravo 11, this is Charlie 92. Occupy firing point 1 on the course road. Battlecarry Sabot. Report Redcon 1. Gas, gas, gas.”* Sound like the Multi-Purpose Range Complex (MPRC) at Fort Carson, or Range 117 at Grafenwoehr? How about Mississippi Army National Guardsmen training in the motor pool at Camp McCain, Mississippi?

Armor leaders in both the Active and Reserve Components face substantial obstacles in maintaining the readiness of tank crews. Shrinking operating and maintenance budgets, strict environmental controls, and a lack of training areas present significant problems to achieving crew readiness. These problems must be overcome with imagination and ingenuity.

Members of Resident Training Detachments (RTDs) must apply all of their technical expertise and experience to assist their Reserve Component counterparts in overcoming problems experienced throughout the Army and those specifically related to the Reserve Component (RC). The RTD built a portable mini tank range for use by 2-198 Armor, MSARNG, to train its tank crews. This mini tank range has been used by active units in Germany and at Fort Carson, Colorado, to compensate for mileage constraints and a lack of available training areas.

The lack of resources causes some units to conduct Tank Tables I-III in the UCOFT rather than on the scaled and subcaliber ranges recommended in FM 17-12-1-1&2. Although this is an acceptable substitute, it fails to involve the entire crew. By using the UCOFT, TCs and gunners achieve a high degree of synchronization. The loaders and drivers, however, are not integrated into the rhythm that a crew must develop. To remedy this shortcoming, most gunnery training programs include flash card or chair drills to train crew drill. A few enterprising tank commanders place their crews on a tank and walk through crew drill. These methods help crew members memorize fire commands, target presentations, engagement ranges, and tower cues, but they do not help a crew improve on the one thing that makes the difference between a qualified or unqualified engagement: full crew coordination and synchronization.

There is a void in our gunnery training in the transition from UCOFT to full crew drill on the tank. In some cases, this leads to coordination problems for the crew on Tank Table IV (Tank Crew Proficiency Course). Failed tasks and numerous reruns result. The mileage savings realized by utilizing the UCOFT can easily evaporate. Most company commanders and platoon leaders recognize this shortcoming, but they are generally not allowed to run a practice TCPC due to mileage constraints or unavailability of training areas.

A mini tank range built on a 4'x8'x3/4" sheet of plywood is a training device that gives crews more opportunity to practice crew drill prior to Tank Table IV. The targets are thermalized using reverse polarity thermal paper, which produces good images in the Thermal Imaging System (TIS). The range is hand-operated, portable, and sturdy. The range's scale and size make it suitable for use in the motor pool, or as a concurrent training station during Tank Table IV (TCPC).

A crew training on the mini tank range exercises all normal crew duties in preparing for and conducting an engagement. The crew places all the tank's systems into operation. The crew is given the "tower talk" that they hear during the table, and evaluation is conducted via jump radio by a Tank Crew Evaluator (TCE). Evaluation criteria is the Tank Table IV timing and scoring tables. Tank Table VIII may be replicated by using the tower cues and the timing and scoring tables for that table.

The limitations of the range include the inability of the loader to battlecarry, the gunner to lase (thereby inducing lead into the system), and the driver to move the tank during offensive engagements.

The inability to battlecarry is inconsequential. The tank commander simply reinforces the drill by announcing "Battlecarry Sabot." The loader announces "Sabot Loaded" and leaves the breech in the open position. Once the engagement is initiated, the loader loads a dummy round to replicate the second round being loaded. The inability to lase is overcome by the tank commander pressing the Battlesight Reset Button to manually induce lead when the gunner begins tracking a target. The inability to move the vehicle

for offensive engagements cannot be overcome; however, the timing and scoring tables for offensive engagements are still used as evaluation criteria. The crew can practice the defense "berm drills" in the motorpool if space and safety allow, or just outside the back gate on a little-used earthen loading ramp if one is available.

The advantages of the mini tank range are full crew participation, the use of all systems in the tank, portability, conservation of mileage, minimum resources required to build and operate the range, and low cost of construction. The entire crew manipulates all controls needed to execute an engagement. The range may be moved by two soldiers and transported by HMMWV or pick-up truck. The tank uses no mileage executing the training. Only two soldiers are required to operate the range, and all required equipment is available at platoon or company level. All materials used to build the range are available through the supply system, local hardware store, or SSSC.

Using dummy rounds during mini tank range training and during a dry Tank Table IV reinforces crew coordination and synchronization while giving crews a more accurate picture of their engagement times. Tank Table IV, with live ammunition and stiff scoring and timing tables, is not the place to discover a coordination problem with the loader. Resulting reruns can add great cost in ammunition expenditures.

AARs must focus on actions which cost the crew time. Was the loader too slow with the second round, or was the gunner too slow pulling the trigger? Feedback such as this helps tank commanders zero in on what corrective training is necessary to shorten the engagement time. The former problem is remedied with mini tank range and Tank Table IV training with dummy rounds. The latter is a matter of a gunner's confidence in his system and is remedied with more time in the UCOFT.

Use of the mini tank range has resulted in better prepared crews and fewer reruns on Tank Table IV. This increased crew proficiency saves both mileage and time. These savings can then be used to practice Tank Table VIII engagements with remaining mileage and time while on the Tank Table IV range.

# TARGET DIMENSIONS

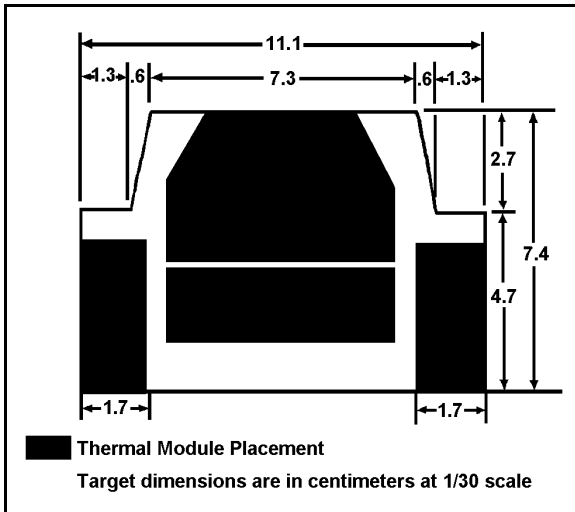

T-72 Front Target

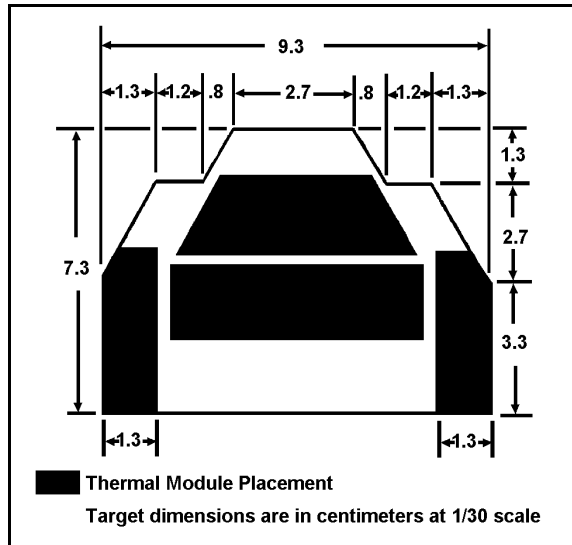

BTR Series Front Target

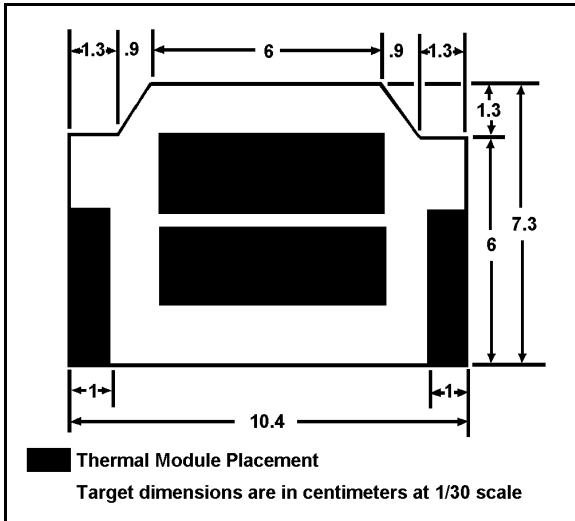

BMP-1981 Frontal Target

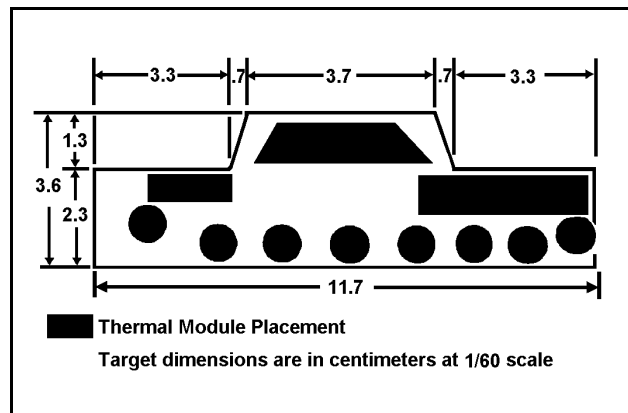

T-72 Flank Target

Targets are cut from 1/2-inch plywood and No Power Thermal Paper is applied to blackened areas with Elmer's Stix All glue.

All stationary target dimensions are for 1/30 scale, replicating engagements at 1800 meters. Tank front slope to range table distance should be 60 meters. The "mover," a T-72 flank target, is scaled at 1/60 to keep the range at a portable size.

Inner surfaces of the "mover" track should be smoothed with 100-grit sandpaper and lubricated with bar soap to ease operation.

Total cost of parts is estimated at \$70.

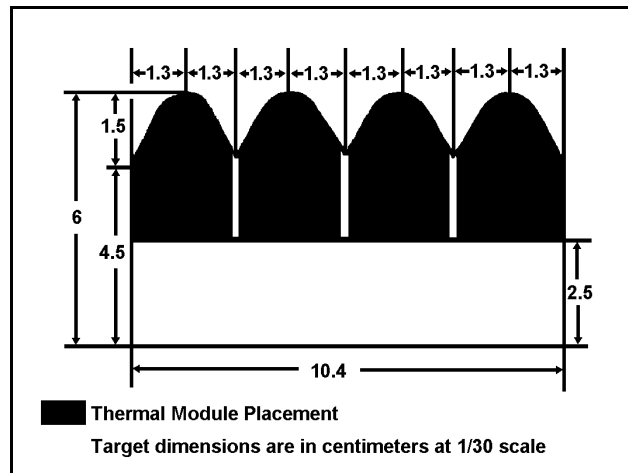

Personnel Target

# ASSEMBLY NOTES

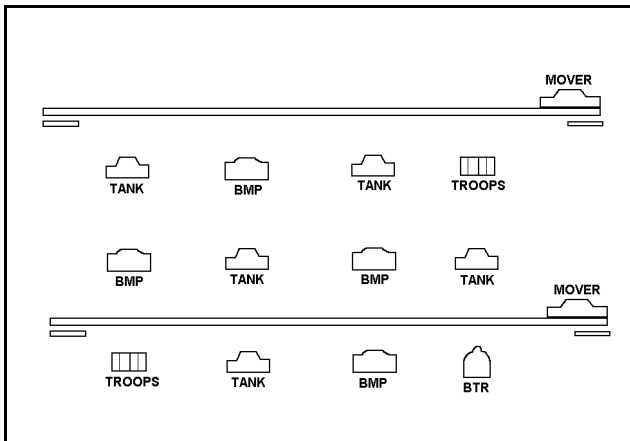

**TARGET LAYOUT**

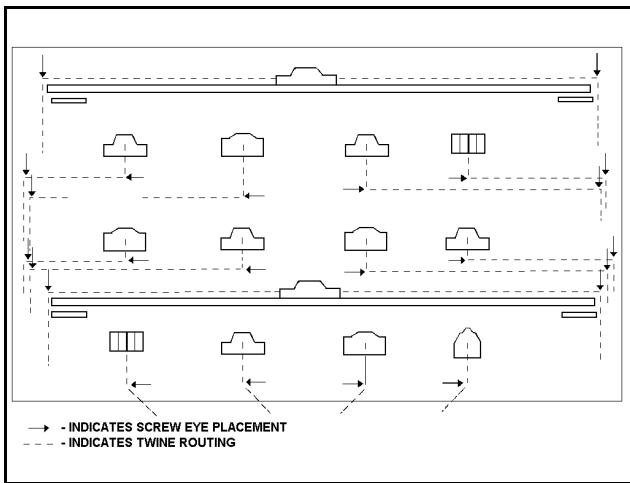

**SCREW EYE PLACEMENT**

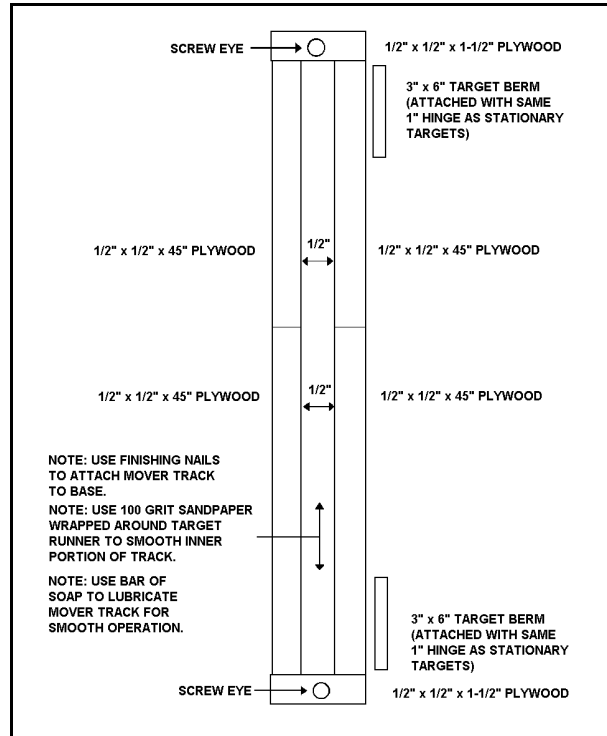

**MOVER TRACK ASSEMBLY**

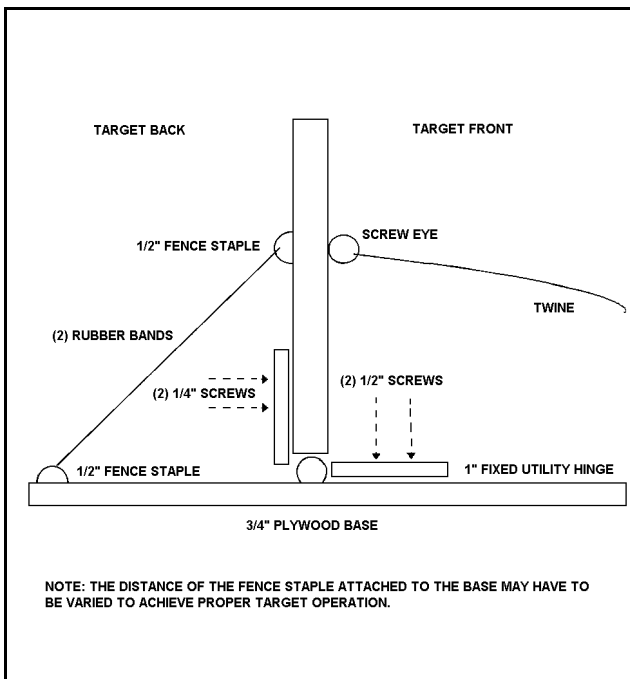

**STATIONARY TARGET ASSEMBLY**

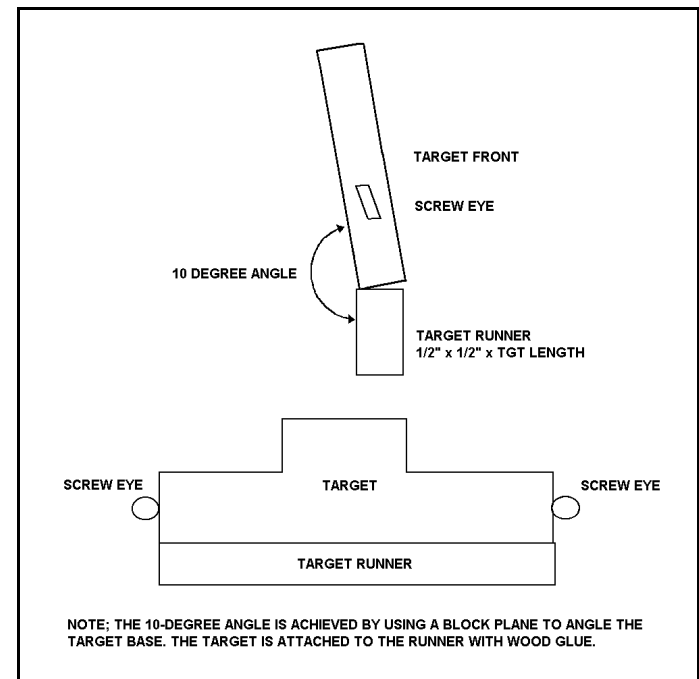

**MOVING TARGET ASSEMBLY**

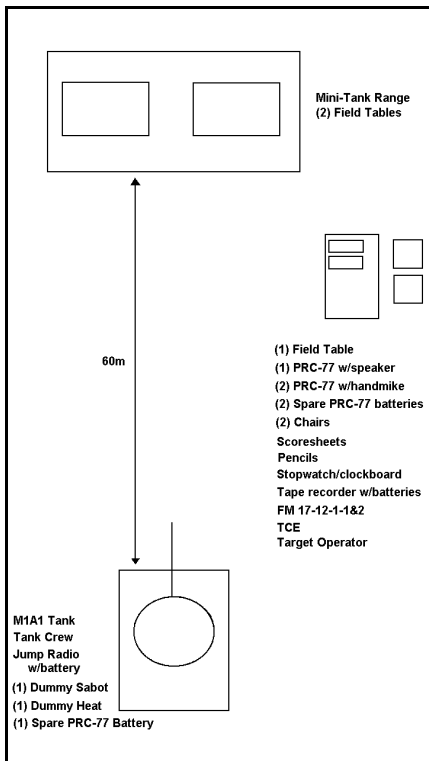

## RANGE LAYOUT

## List of Materials

- 1 4x8 plywood sheet - 3/4"
- 1 4x4 plywood sheet - 1/2"
- 16 1" fixed pin utility hinges
- 32 1/2" flat head wood screws
- 32 1/4" flathead wood screws
- 32 3/4" screw eyes
- 1/4 lb. 3D finishing nails - 1" long
- 2 cans OD spray paint
- 1 roll heavy binding twine
- 1 bar bath soap
- 1 box heavy rubber bands
- 1/4 lb. 1/2" fencing staples
- 1 tube Elmer's Stixall glue
- 1 sq. yd. No Power Thermal Target Material PN CAMCAL 210G095
- 1 bottle Elmer's Wood Glue

### TOOLS:

Jigsaw, ruler, hammer, cross-tip screwdriver, scissors or knife, awl, 100-grit sandpaper, block plane.



Overall view of the completed mini tank range



The completed mini tank range, as seen through sight set to Black Hot

## Range Setup List

- 1 M1A1 tank
- 1 mini tank range
- 3 field tables
- 1 PRC-77 w/speaker, batteries
- 1 PRC-77 w/hand mike, batteries
- 1 jump radio w/batteries
- 1 stopwatch, clockboard
- 1 FM 17-12-1&2
- scoresheets
- pencils
- 2 chairs
- 1(ea) sabot, HEAT dummy rnds
- 3 spare PRC-77 batteries
- 1 tape recorder w/batteries

Captain Gregory M. Parrish is a 1986 Distinguished Military Graduate of West Texas State University. A graduate of AOBC, AOAC, Airborne, JOMC, Scout Platoon Leader, M1A1 Tank Commander Certification, and Northern Warfare Courses, he has served as a tank platoon leader in A/2-70 Armor, company executive officer in B/2-70 Armor, 1st Armored Division, Erlangen, FRG; assistant S3, 3d Brigade, 4th Infantry Division (Mech); and commander of A/2-77 Armor, 4th Infantry Division (Mech), Fort Carson, Colo. He is currently assigned to HHC, 1st Cavalry Division as a member of a Resident Training Detachment (RTD) with duty at 2d Battalion, 198th Armor MSARNG, Greenville, Miss.

# BOOKS

**Knight's Cross — A Life of Field Marshal Erwin Rommel** by David Fraser. Harper Collins Publishers, N.Y., 1994. 601 pages, chronology, maps, bibliography, notes. \$30.00.

Even young Armor troopers who can't tell you where El Alamein is have heard about Rommel and his exploits during the early days of World War II. In this book, General David Fraser, a distinguished British biographer and historian, takes an unbiased and objective look at Rommel, both the legend and the whole man, and gives us the very best book on Rommel to date.

The Legend doesn't suffer from Fraser. Indeed, Rommel's remarkable story is given in fine detail, from his youth to his heroism in World War I (when he won Germany's highest award for bravery) to his sensational campaigns across North Africa. Fraser emphasizes what others called Rommel's *Fingerspitzengefühl*, his sixth sense, "his almost animal response to the dangers, the chances, the currents of battle" that distinguishes a great battlefield commander. "No man has ever been more conscious of time, of the fleeting nature of opportunity, of the rapidity with which the commander must act or react." Fraser shows how Rommel continually focused on what might or could shift the balance in battle, particularly when that balance could be affected by his own presence on the scene. "He [Rommel] always believed in personal intervention and inspiration at the critical point in battle. The critical point may not always be where shot is flying; on 29 May [1942] the critical point for Afrika Corps was where a supply column was attempting to reach 15th Panzer [Division], and Rommel placed himself at that critical point and ensured success" by personally leading that column to 15th Panzer at four o'clock in the morning over a route that everyone else had missed!

Yet Fraser is careful to balance this heady stuff with the factual, and not so glorious, facets of Rommel that the world didn't see (or chose not to). This includes Rommel's successful efforts to cultivate a friendship with Hitler and later to take advantage of that friendship. Rommel first met Hitler in 1934 when his battalion provided an honor guard for Hitler's visit to Goslar. "Hitler had a message for all generations: he comforted the fears and consoled the resentments of middle age, as surely as he appealed, with considerable success, to the idealism of youth... Hitler was, it seemed, promoting modernity [in the army], whether in attitudes to mess-management or in his evident interest in weaponry. That was good. By his...show of confidence in the army, Hitler was proclaiming to Germany that to be a good sol-

dier was again a proud, honored thing. That was very good."

Rommel found nothing disturbing about Hitler or the Nazi attitudes toward the army, and he continued steadfastly in that belief well beyond the time when other senior German officers became alarmed at Hitler's demands.

Fraser also points out some of Rommel's less distinguished adventures, and how his impetuous drive to move immediately against any perceived enemy had occasional setbacks. The first Tobruk campaign was one. Rommel was convinced the British were on the run, that the defenders would have insufficient time to recover their balance and nerve, and that speed and determination could take Tobruk. He was wrong. The 9th Australian Division showed little inclination to roll over. "Their artillery fire was heavy and accurate on every oc-



casions; their strongpoints were manned and fought with tenacity...Tobruk was formidable." It took Rommel 14 months to crack that defense.

Another interesting section of the book deals with a particularly objective (for an Englishman!) analysis and comparison of Rommel and Montgomery. The conclusions are enlightening!

Fraser also looks thoroughly at Rommel's activities in France just before and during the Allied invasion. There is a very interesting presentation of the argument between Rommel and General Freiherr Geyr von Schweppenburg, commander of Panzer Group West, on how best to defend against the coming invasion. It was agreed that "it would be absolutely vital to counterattack such penetrations as fast and as strongly as possible." Rommel argued that he must have control of sufficient armor from the start and that it must be deployed near the coast because during the early hours of invasion, time was more important than overwhelming strength. The other side of the

argument was "that the best and only way to deal with [a major enemy deployment] would be by maneuver with the maximum concentrated armored strength, strength reserved for the maneuver and not frittered away on operations of only local significance." Field Marshal von Rundstedt, Rommel's superior, sided with Geyr and history provided the outcome. Nevertheless, this is an important and valid argument, one that the Armor School might well use as a teaching point.

This book is replete with real-life lessons for every Armor leader. Battle field communications. Tactical intelligence gathering. The importance of personal leadership of troops in battle. Demanding training. Logistics. Lots of logistics! "The first and most enduring criticism [of Rommel] is that he either failed to understand or paid inadequate attention to logistics." Numerous examples are given of units up to division strength forced to halt in the midst of battle simply because they ran out of fuel. "In a sense the criticism is fair: Rommel believed — and the belief has historic justification, not only in Panzerarmee Afrika — that to set the pace and scope of operational ambition primarily by calculations of supply may be to risk little but is often also to achieve little." The commander who never risks running out of fuel is inclined to risk nothing, and he who risks nothing seldom wins.

As good as this book is, it has one major fault: the poor quality of its maps. The battle descriptions are precise, fast moving and detailed, but there is no way the reader can follow the action on the few maps which have only the most general topographical information. Maps like those in von Mellethin's *Panzer Battles* would add considerably to this book. Even so, this is a first-rate look at one of the great captains of Armor, and a fine enduring addition to every Armor leader's bookshelf.

COL JOHN R. BYERS  
Alexandria, Va.

**Mogadishu! Heroism and Tragedy** by Kent Delong and Steven Tuckey; Forward by Ross Perot. Praeger Publishers, Westport, Conn., 1994. 144 pages, \$19.95.

*Mogadishu!* provides a definitive examination of U.S. forces operations during October 3-4, 1993. Purportedly, more decorations for valor "were given for actions during this evening than in any other single action of this size in U.S. military history."

Relying heavily on interviews with the participants, the book's somewhat over-

drawn style is reminiscent of General S.L.A. Marshall's action histories. *Mogadishu!* is disturbing. The authors picture an American force that was complacent, over-reliant on extant standard operating procedures and inadequately reinforced. Critical readers may find the authors' fund of general military knowledge disconcertingly sparse.

*Mogadishu!* focuses on the events that resulted in 18 American dead, Chief Warrant Officer Michael Durant's public captivity, and the posthumous award of two Congressional Medals of Honor. During a special operations mission to capture indigenous politico-military personnel, two helicopters were shot down by heavy small arms and rocket fire, which also fixed the special operations teams and the supporting force of U.S. Army Rangers. Massed fires from rotary wing aircraft and relief forces mounted in wheeled vehicles were unable to provide freedom of maneuver to the initial assault force. Light armored vehicles positioned in the area of operations by the governments of Pakistan and Malaysia proved necessary to extract these U.S. forces.

The accounts narrated depict a rapid transition from monotony to violent action and emphasize the need for American forces to have access to mobile firepower and combat shock action in every contingency. The book is a worthwhile read without the dryness of many battle accounts.

1LT KEVIN M. RIEDERS  
Ft. Polk, La.

**A Doughboy With the Fighting 69th: A Remembrance of World War I** by Albert M. Ettinger and A. Churchill Ettinger. Pocket Books, N.Y., 1992. 339 pages, \$5.99.

Seventy-seven years after the armistice that ended WWI, the Great War still fascinates us. Here, in vivid detail, is the story of an individual soldier who served in the 69th New York National Guard (165th United States Infantry). Dedicated to the foot soldiers of the regiment and their comrades of the 42nd Rainbow Division, *A Doughboy With the Fighting 69th* is a series of related vignettes about the soldiers who went "over there" to battle the Kaiser in 1917.

At the time of his enlistment, the author was an "emphatic, adventuresome youth of 17, quick to take offense, and inclined to cherish both friendship and enmities." Joining the regiment's pioneer platoon, Albert "Red" Ettinger later served as a regimental dispatch rider, where he occasionally met the Rainbow's inimitable chief of staff, COL Douglas MacArthur. Ettinger's greatest thrill

occurred when MacArthur described him as "a good soldier."

Here are the stories of the regiment's most distinguished heroes, later immortalized in the 1940 Warner Brothers film, "The Fighting Sixty-Ninth." Readers will recognize COL "Wild Bill" Donovan, later the founder of the OSS, as the regimental commander. "Fighting" Father Francis Duffy served as the senior chaplain of the regiment and, according to Ettinger, the unit's military success was due as much to the men's bed-rock confidence in this inspirational priest as it was to the talents of its combat officers. Also present are first-hand accounts of the poet Joyce Kilmer, who urged the author to keep a diary before Kilmer's own death at the Ourcq River on July 28, 1918.

What makes these reminiscences so interesting is the foot soldier's perspective of military life and the horrors of combat. Like most soldiers, Ettinger and his comrades complained about the chow, prepared for inspections that never took place, trudged along on grueling marches, and were too "young and dumb" to think much about the hazards of going AWOL. Yet, when they marched into the Meuse-Argonne, they faced the prospect of death without flinching, convinced in the righteousness of their cause.

The author died in 1984 and his son, A. Churchill Ettinger, prepared his father's reminiscences for publication. Surprisingly, the junior Ettinger ponders the difficulty for today's generation to comprehend why one and a half million Americans enlisted to fight in an overseas war having little perceptible threat to the country's national security. Perhaps the secret lies in an America that has long since vanished from our consciousness. That America, as is this book, is a story about a "remarkable breed of two generations past, many of whom were truly heroic."

COL COLE C. KINGSEED  
USMA, Dept. of History  
West Point, N.Y.

**Company C: The Real War in Iraq** by John Sack, William Morrow and Company, New York, 1995. 256 pages. \$22.00.

The Gulf War has generated its share of historical accounts, including official and unofficial histories, articles in professional journals, and memoirs by senior officers. What has not yet emerged is the story of the individual men and women who fought the war. John Sack attempts to fill this void with his in-depth look at the experiences of Company C, 2-34 Armor, 1st Brigade, 1st Infantry Division, between December 1990 and May 1991.

John Sack was a war correspondent in Korea, Vietnam, and in the Gulf. In each

war, he stayed with soldiers during their training and later during combat. He was one of the few reporters who was with a combat unit during the ground offensive into Iraq — the result of the Pentagon's press policy which kept most correspondents far behind the action. Unfortunately, CNN proved a poor substitute for Ernie Pyle (of World War II fame) and other reporters like him who got to know soldiers intimately by living among them for extended periods of time.

*Company C* is an account of the soldiers who fought in Iraq and Kuwait at the tip of the spear in the largest armored battle in American history. Sack writes of their preparation in Fort Riley and of their lives at home, church, work, and "play." He does not discuss strategy, operations, or tactics, techniques, and procedures. Readers interested in those topics will be disappointed by this book and would be better served by referring to the numerous articles that have appeared in professional publications since the end of the war. *Company C*, rather, is a story of some of the soldiers who fought the war, soldiers who had as much in common with Sherman tank crewmen in France in World War II or armored cavalymen in Vietnam as they had with soldiers serving to their rear in Saudi Arabia. This was the war denied to the public on television but real enough to those who fought it.

One of the striking aspects of the story is the degree to which the fear (and reality) of friendly fire dominated the actions of commanders during the battle. The commander of Company C nearly paralyzed his unit at times by ordering his tank commanders to get his permission before engaging targets. This policy undoubtedly saved lives, since Company C neither suffered nor inflicted any friendly fire casualties and lost no one to enemy fire. It would be dangerous, however, to extrapolate this experience to future conflicts against potentially more capable adversaries. The commander who tries to over-control his forces in a fast-paced armored battle — which is at best organized chaos — invites disaster. Company C's story validates the pressing need for effective thermal identification systems for armored vehicles on today's battlefield.

The author's prose is targeted towards a civilian audience and reads more like a novel than a non-fiction account. The book could use more photos to help the reader identify with the soldiers (the only photo is the one on the cover) and a map to assist in visualizing where Company C fought in Iraq and Kuwait. Nevertheless, the story is a quick and interesting read and a valuable addition to the existing literature on the Gulf War.

MAJ PETER R. MANSOOR, Ph.D.  
CGSC Class 94-95  
Ft. Leavenworth, Kan.

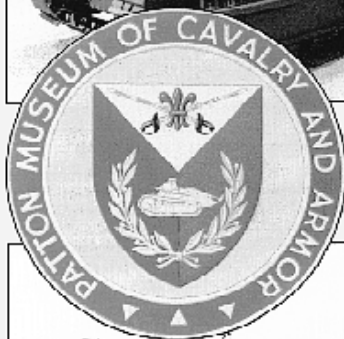
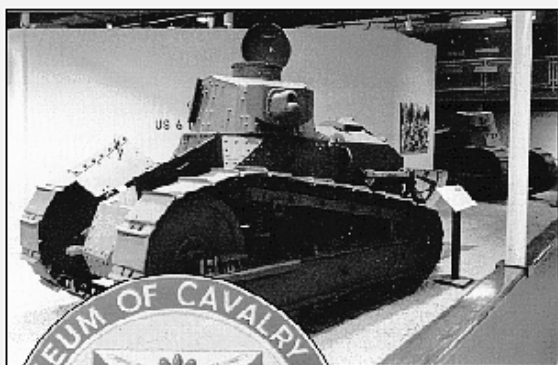

## FIGHTING VEHICLES of the PATTON MUSEUM



# A Patton Museum Guide Book

**Fighting Vehicles of the Patton Museum** by Gordon A. Blaker, Privately Printed, 1995. About \$10.

About ten years ago, when he was an Advance Course student at Fort Knox, Gordon Blaker began a project that is only now coming to fruition, the publication of a guide book listing and describing the major vehicles in the Patton Museum collection.

The book is scheduled to be off the press in early July, and will be available at the Museum bookstore, according to John Purdy, museum director. The author, who has published the book himself, said it will also be available by mail and may be added by several book outlets for sales by mail.

Blaker said he first conceived the project on his initial visit to the museum. Working on and off through several drafts, the final result is about 100 pages. Ninety vehicles are covered, each with a large photograph, a descriptive paragraph, and a chart listing specifications like engine type, armament, weight, speed, range, and exterior dimensions. In some

cases, there is also fascinating information on how the museum acquired the vehicle.

The book's "chapters" are divided into time periods, beginning with the Museum's World War I holdings and continuing through the vehicles acquired during Desert Storm. One interesting section describes U.S. prototype tanks, like the heavies built but never used for World War II, including the turtle-like T-28 "super heavy tank" designed to smash the Siegfried Line. It was the heaviest U.S. tank ever built at 95 tons. This tank currently is on display at the front of the museum.

There is also a useful bibliography for those who want to go further.

Nominally priced, the guide book should help enrich the experience of visitors and will be a useful reference for scholars, modelers, and military vehicle collectors. It will be available from the author by mail at 1504 N Avenue, LaGrande, OR 97850, or phone (503) 963-6823.

— ARMOR Staff