

# ARMOR

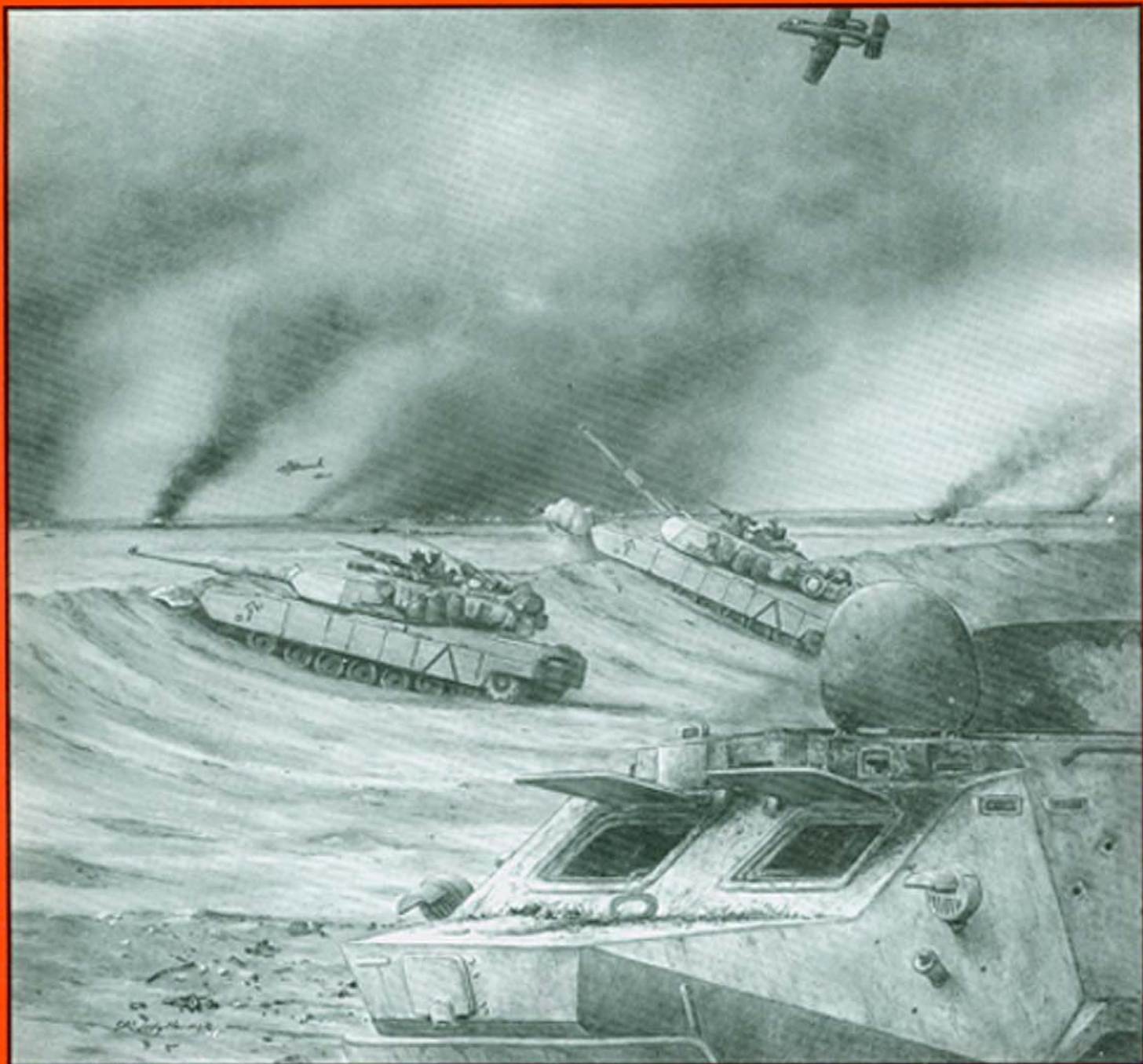

## WINNERS IN IRAQ — WAXED AT THE NTC

*A veteran Armor task force ignores the dismount threat — and pays. Page 6*

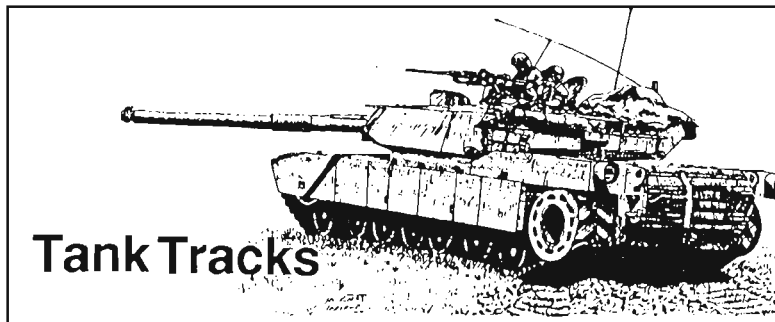

Five years. In our profession, it is not unusual for an officer to stay in one place for five years. But to remain in the same job, in the same office for that long is rare indeed.

Whatever we've been able to accomplish with this publication and in the United States Armor Association has been due to the great staffs I've been associated with in both organizations and to that most precious of commodities — time. As I move on to whatever lies ahead, I want to publicly acknowledge the great work done by the folks at *ARMOR* and the Association. You readers can be proud of what they have done and of what they will continue to do.

I also want to thank the hundreds of individuals with whom I have come in contact over the past half-decade: the authors, reviewers, commanders, and many, many supporters and readers. I can truthfully say it has been the highlight of my career to have worked with you. Keep up the good work.

Our branch is strong. This job has given me an eagle's-eye view of the force and left me with a distinct impression of the professionalism, elan, esprit, and tradition of Armor and Cavalry.

Back in 1950, when Armor officially became a branch, Hanson Baldwin wrote in *ARMOR*, "The cavalry is not dead; its spirit, its traditions, its immortal intangibles endure. Its tactics, its esprit are the heritage of armor and the Army; the 'yellow legs' are gone, but they have left behind them the

things that soldiers live by." We are the stewards of that legacy, as much today as when he wrote those words more than 40 years ago.

The force has a bright future. In a previous era, when some said that we were not needed, General Jacob L. Devers wrote in the old *Armored Cavalry Journal* in 1948, "The future of armor is limited only by the ingenuity of American industry and the resourcefulness of the officers and enlisted men who belong to armored units. To those qualities there are no limits — nor are there to the future of armor."

The missions change. The doctrine evolves. The threat transforms. But there will always be a need for a fast-moving, high-trained, professional, direct-fire ground force that can deploy anywhere in the world, fight, and win. No one else can do what we do or do it as well. There are dragons out there, and they have lots of tanks. So, there will always be the possibility of work to do. In 1975, General Donn A. Starry wrote in *ARMOR*, "...modern war games show that a force in which tanks are either not present, or present in insufficient numbers, simply cannot fight successfully against an enemy equipped with even a modest number of tanks." We know that to be true, and we know we're the force for the job.

So, keep those letters and articles coming, folks. It's been a great run. Thanks for the opportunity.

— PJC

By Order of the Secretary of the Army:

GORDON R. SULLIVAN  
*General, United States Army*  
 Chief of Staff

Official:

*Milton H. Hamilton*  
 MILTON H. HAMILTON  
 Administrative Assistant to the  
 Secretary of the Army

01557

# ARMOR

The Professional Development Bulletin of the Armor Branch PB-17-92-3

Editor-in-Chief  
LTC PATRICK J. COONEY

Managing Editor  
JON T. CLEMENS

Commandant  
MG THOMAS C. FOLEY

ARMOR (ISSN 0004-2420) is published bimonthly by the U.S. Army Armor Center, 4401 Vine Grove Road, Fort Knox, KY 40121.

Disclaimer: The information contained in ARMOR represents the professional opinions of the authors and does not necessarily reflect the official Army or TRADOC position, nor does it change or supersede any information presented in other official Army publications.

Official distribution is limited to one copy for each armored brigade headquarters, armored cavalry regiment headquarters, armor battalion headquarters, armored cavalry squadron headquarters, reconnaissance squadron headquarters, armored cavalry troop, armor company, and motorized brigade headquarters of the United States Army. In addition, Army libraries, Army and DOD schools, HQ DA and MACOM staff agencies with responsibility for armored, direct fire, ground combat systems, organizations, and the training of personnel for such organizations may request two copies by sending a military letter to the editor-in-chief.

Authorized Content: ARMOR will print only those materials for which the U.S. Army Armor Center has proponency. That proponency includes: all armored, direct-fire ground combat systems that do not serve primarily as infantry carriers; all weapons used exclusively in these systems or by CMF 19-series enlisted soldiers; any miscellaneous items of equipment which armor and armored cavalry organizations use exclusively; training for all SC 12A, 12B, and 12C officers and for all CMF-19-series enlisted soldiers; and information concerning the training, logistics, history, and leadership of armor and armored cavalry units at the brigade/regiment level and below, to include Threat units at those levels.

Material may be reprinted, provided credit is given to ARMOR and to the author, except where copyright is indicated.

May-June 1992, Vol. CI No. 3

## Features

- 6 **A Tale of Two Battles**  
by First Lieutenant (P) John A. Nagl
- 11 **Dragon's Roar: 1-37 Armor in the Battle of 73 Easting**  
by Second Lieutenant Richard M. Bohannon
- 18 **Tactical Employment of the Military Motorcycle**  
by Lieutenant Colonel Craig S. Harju Sr.,  
Sergeant First Class David F. Wilson, and Richard B. Armstrong
- 21 **Remembering** by Major Dale E. Wilson and  
Command Sergeant Major Robert A. Murphy
- 24 **Flying A Desk**  
by Captain John K. Bartolotto
- 26 **Bernard Law Montgomery: A Question of Competence**  
by David Craig
- 32 **The Battle of Arras**  
by Captain Charles H. Benson III
- 37 **Using "Push Packages" To Resupply Cavalry Operations**  
by Captain Daniel A. Beach
- 41 **You Can't Push Wet Spaghetti**  
by Colonel John C. Gazlay, USA, Retired
- 42 **MILES Rules the Battlefield**  
by Sergeant First Class Richard S. Francis
- 44 **Short Halt Maintenance**  
by First Lieutenant (P) Bradley T. Gericke
- 46 **Remarks at the Dedication of the Abrams Auditorium,  
Patton Museum of Armor and Cavalry**  
by General Donn A. Stary, USA, Retired

## Departments

- |   |                   |    |                         |
|---|-------------------|----|-------------------------|
| 2 | Letters           | 20 | Armor Soldiers Monument |
| 2 | Contacts          | 48 | Tank Design Contest     |
| 4 | Commander's Hatch | 50 | Bustle Rack             |
| 5 | Driver's Seat     | 51 | Books                   |

**ATTENTION FREE DISTRIBUTION APO ADDRESSEES:** Please send your new address and unit number to ARMOR, ATTN: ATSB-AM (Ms. Hager), Ft. Knox, KY 40121-5210. Be sure to include your current mailing label.

Second-class official mail postage paid at Fort Knox, KY, and additional mailing offices. Postmaster: Send address changes to Editor, ARMOR, ATTN: ATSB-AM, Fort Knox, KY 40121-5210.

Distribution Restriction: Approved for public release; distribution is unlimited.

USPS 467-970

# LETTERS

## Fire Support for the ACR: Another Opinion

Dear Sir:

I enjoyed reading Captain Reagor's article, "The Guns of the Cavalry," (Nov-Dec 1991). However, my experience as the regimental fire support officer for the 2d ACR has led me to a different set of conclusions.

Captain Reagor's basic thesis is that there needs to be a field artillery battalion

headquarters in an armored cavalry regiment. His argument is that the artillerymen in a regiment need branch specific centralized control for training, career management, and to provide better overall fire support. I disagree.

First, and foremost, the armored cavalry squadron is designed to fight independently of the other squadrons. That is the primary reason for an organic howitzer battery (HWP). Traditional cavalry missions (screen, guard, cover) all may require the unit to operate autonomously, separate from its sister units. If the regiment were

designed to always fight as a heavy brigade, then I would agree, but they're not.

An armored cavalry regiment may occupy a screen line over 50 kms. wide, with three squadrons abreast. Under this scenario, it would get little benefit from a TACFIRE shelter and the maturity of a FA lieutenant colonel. The FA battalion commander would be hard pressed just to talk to his commanders, never mind provide adequate artillery fires across the sector.

I also find the argument that available FA staff positions adversely affect officer transition and career development to be incor-

## DIRECTORY — Points of Contact

(Note: Fort Knox Defense Switch Network (DSN) prefix is 464. Commercial prefix is Area Code 502-624-XXXX).

### ARMOR Editorial Offices

<b>Editor-in-Chief</b>	
Lieutenant Colonel Patrick J. Cooney	2249
<b>Managing Editor</b>	
Jon T. Clemens	2249
<b>Editorial Assistant</b>	
Vivian Thompson	2610
<b>Production Assistant</b>	
Mary Hager	2610
<b>Contributing Artist</b>	
SPC Jody Harmon	2610

**MAILING ADDRESS:** ARMOR: ATTN: ATSB-AM, Fort Knox, KY 40121-5210.

**ARTICLE SUBMISSIONS:** To improve speed and accuracy in editing, manuscripts should be originals or clear copies, either typed or printed out double-spaced in near-letter-quality printer mode. We also accept stories on 5-1/4" floppy disks in MultiMate, WordStar, Microsoft WORD, WordPerfect, XyWrite, Xerox Writer, and ASCII (please include a double-spaced printout). Please tape captions to any illustrations submitted.

**PAID SUBSCRIPTIONS:** Report delivery problems or changes of address to Ms. Connie Bright, Secretary-Treasurer, P.O. Box 607, Ft. Knox, Ky. 40121 or call (502)942-8624, FAX (502) 942-6219.

**UNIT DISTRIBUTION:** Report delivery problems or changes of address to Ms. Mary Hager, DSN 464-2610; commercial: (502)624-2610. Requests to be added to the free distribution list should be in the form of a letter to the Editor-in-Chief.

### ARMOR HOTLINE — DSN 464-TANK

(The Armor Hotline is a 24-hour service to provide assistance with questions concerning doctrine, training, organizations, and equipment of the Armor Force.)

### U.S. ARMY ARMOR SCHOOL

<b>Commandant</b>	(ATZK-CG)
MG Thomas C. Foley	2121
<b>Assistant Commandant</b>	(ATSB-AC)
BG James L. Noles	7555
<b>Deputy Assistant Commandant</b>	(ATSB-DAC)
COL John B. Sylvester	1050
<b>Command Sergeant Major</b>	
CSM Richard L. Ross	4952
<b>Armor School Sergeant Major</b>	
SGM Douglas K. Merrill	2900
<b>Maintenance Department</b>	(ATSB-MA)
COL Phares E. Noyes	8346
<b>Command and Staff Department</b>	(ATSB-CS)
COL Pat O'Neal	5855
<b>Weapons Department</b>	(ATSB-WP)
COL E. G. Fish II	1055
<b>Directorate of Training Developments</b>	(ATSB-TD)
COL Joseph D. Molinari	7250
<b>Directorate of Combat Developments</b>	(ATSB-CD)
COL Edward A. Bryla	5050
<b>NCO Academy/Drill Sergeant School</b>	(ATZK-NC)
CSM Taft D. Webster Sr.	5150
<b>Reserve Component Spt Div</b>	(ATZK-PTE)
COL Eduardo Yates	5953
<b>Directorate of Total Armor Force Readiness</b>	(ATZK-TF)
LTC Robert C. Mitchell	FAX - 7585 7809
<b>TRADOC System Manager for Armored Gun System</b>	(ATSB-TS)
COL Eugene D. Colgan	7955

rect. The MTOE positions within a HWB for lieutenants (FIST, FDO, platoon leader) are what young artillerymen need to learn to do. I cannot imagine why a FA lieutenant would want to serve as a battalion S1 or assistant. The two captain positions (BC and FSO) are again the right jobs for an artilleryman.

Having said that, keep in mind that the cavalry commanders are smart guys. They will professionally develop all their officers regardless of branch. In my two years in the regiment I have seen artillery officers serve not only in their MTOE positions, but as squadron S1s, squadron assistant S3s, LNOs, and even assistant regimental S3s and S4s.

I would argue that due to the close association to the maneuver guys and the multiplicity of training opportunities, most artillerymen leave the regiment as more qualified fire supporters (our business) than their peers in the DIVARTYs and FA brigades. No one suffers professionally because he is a cavalryman.

Training is another area on which Captain Reagor and I have divided views. HWB commanders are chosen because they have already proved that they are competent and mature leaders. Many have had previous commands and all have vast experience in cannon units. The young commanders within this regiment are more than capable of designing, in concert with commander's guidance, the squadron S3 and the RFSO, a training program that will prepare their battery for combat.

Captain Reagor's argument that the HWBs lack experience with TACFIRE is a valid one. However, the TACFIRE argument needs to be kept in the proper perspective. In light of recent experiences, how important is TACFIRE to the regiment? Was it really a fire support multiplier in SWA?

We in the 2d ACR use the "plan digital, execute voice" manner of training, much like many of our DIVARTY brethren throughout the Army. We have developed close training ties with nearby artillery battalions. While we are by no means experts in all areas of digital operations, the squadron FSEs all have variable format message entry devices and are quite capable of inputting targets, plans, and geometry. As far as the FISTs are concerned, it is basically transparent who they send a digital mission to, the shelter or BCS. Our FDCs would rather work in the "A" mode, but, as a matter of course, have to link digitally with a shelter to fire certain missions on each ARTEP and most exercises. I do not mean to imply that we could not have gotten better, but in light of the system's overall util-

ity, this is a large step for questionable gain. In SWA, the regimental artillerymen were able to link digitally, and had no more trouble than most, with the supporting FA battalion's and brigade's TACFIRE shelter.

As far as standardization goes, I do not buy the argument that all three HWBs have to operate differently. Within the 2d ACR there is a common company/troop/battery SOP for generic operations and reports. There are three separate tank companies (one per squadron), whose tactical operations and drills are the same. Being, as the author states, "fiercely independent" is not an excuse not to get in step with the rest of the Army and have common procedures and drills. Make the RFSO, SFSOs and the HWB leadership sit down and work out a common SOP with which they can all live. Granted, this will be no easy task, and will most likely require RCO "interest," but the benefits are enormous.

My final thoughts are rhetorical questions concerning task organization of FA assets to support your combat operations. Captain Reagor stated that during part of DESERT STORM the HWBs were in their organic status (i.e. not OPCON to 3-18 FA), and the FA battalion moved centered on the two lead squadrons. I am curious as to the tactical relationship and the call for fire processing in this task organization. Was the FA battalion DS to the regiment; or was it reinforcing the HWBs (certainly a nonstandard relationship)? To whom did the FISTs send calls for fire? Doctrinally, if 3-18 FA was DS to the regiment, then all 15 FIST/COLT teams would send their missions through the battalion shelter leaving the HWBs out of the loop. If the FIST sent its missions to the HWB, then 3-18 was in a reinforcing role and got all its fire missions from the HWB through a request for additional fires (RFAF). Obviously, this is not the best way to get accurate, predicted, massed fires.

Another option may have been to make the FA battalion DS to the regimental main effort squadron with its HWB OPCON to the battalion, and leave the other HWBs organic, or in a DS role to its squadrons. Position the FA battalion so that it can cover the main effort squadron and at least some of the other lead squadron's zone. This guarantees quickly massed fires in the main effort zone. You will accept some risk in the other zone, but the regimental commander does have attack helicopters he can use to influence the fight. This will prevent you from piecemealing your fire support and not supporting your main effort when you need it most.

Supporting the ACR with adequate artillery fires is an interesting and often per-

plexing problem. Congratulations to Captain Reagor for his thought-provoking article.

JOHN V. KLEMENCIC  
MAJ, FA  
2d ACR

## Some Past Innovations In Guard/Reserve Training

Dear Sir:

The exchange of viewpoints on Guard and Reserve training (Jan-Feb 92) between COL Bruce B.G. Clark and COL Joseph D. Molinari is enormously important in light of the restructuring of both the Active and Reserve Components now in progress.

A bit of background may be helpful.

Sometime in the 1950s — sadly, I did not retain a copy — a tank troop commander from the 106th Armored Cavalry Regiment, Idaho Army National Guard, published an article in *ARMOR* describing how he had gotten together with the command of a Marine Corps Reserve rifle company and conducted weekend combined arms training in Idaho Guard's superb Gowen Field training area south of Boise. This was a time when the Army Guard and Reserve operated on the basis of 48 two-hour evening drills and the traditional two-week "summer camp."

In 1959, I took command of Troop D, 104th Armored Cavalry, Pennsylvania ARNG. I was also at that time the State Public Affairs Officer. That gave me daily direct contact with the late COL Clair Stouffer, former 104th commander, and by then U.S. Property and Fiscal Officer for Pennsylvania. To make a long story short, Colonel Stouffer made available barracks, training areas, five M-48s with OEM in place, plus one spare, all needed maintenance above company level, and some imaginative pay and rations procedures to make possible application of the 106th ACR training concept at what is now Fort Indiantown Gap.

I mean no disrespect to Colonel Molinari, but many of the objections he makes to Colonel Clarke's training concept have a familiar ring. In various forms — in particular the issues of personnel turnover and absentees — many of the same arguments were used to attempt to defeat our efforts. As it turned out, during a succession of "platoon weekends" our attendance averaged 104 percent — a nice coincidence with the regimental designation — because of men, including the entire maintenance

*Continued on Page 48*

*MG Thomas C. Foley  
Commanding General  
U.S. Army Armor Center*



## A Bright Future: Armor Continues to Move

I wish every Armor and Cavalry soldier would have had the opportunity to attend this year's Armor Conference from 5-7 May. No one could have come away from those three days without a renewed sense of excitement at the momentum of Armor as we drive into the challenges of the next century. What is especially striking is the contrast between this conference and a much different setting just two years ago. At that time, Armor was facing another of the periodic assaults of the false prophets who announce the death of the branch. Yet again, the negativists read the signs incorrectly. The collapse of the Soviet Union turned the strategic world upside down, but did not repeal the principles of war, nor make victory any less dependent upon the mobility, firepower, and shock effect of the mobile mounted arm.

This year's conference was a showcase of the vitality of your branch. Let me cite some examples of the good news:

- Armor's share of the Total Army will increase over the rest of the decade. Within the Active force, for example, we will grow from just over four percent of the force now to almost five percent of the force by Fiscal Year 1999. Armor's share of the Army National Guard will also expand.

- In concert with our changing national strategy, our ability to deploy rapidly is improving greatly. We are now in the process of fielding a true light Armor Force. Over the rest of this decade, the airborne armor soldiers of the 3-73rd Armor will be joined by two more light armor battalions and by a light armored cavalry regiment. All of these units will be

built around the Armored Gun System (AGS). We will begin fielding the AGS beginning in 1995. The light armored cavalry regiment will be born in July of this year with the reflagging of the 199th Light Infantry Brigade as the 2nd Armored Cavalry Regiment (Light). Many of the serving armor soldiers reading this article will spend significant portions of their careers in these exciting and challenging units.

- Tank modification and conversion is on track. Funding realities have required a fundamental reshaping of the tank modernization program, but what is emerging is a clear cut set of programs to address our near-, mid-, and long-term needs. The M1A2 program will produce 62 state-of-the-art tanks. Prototypes are fielded and in training for a rotation at the National Training

*Continued on Page 49*

*CSM Richard L. Ross  
Command Sergeant Major  
U.S. Army Armor Center*



## As We Face the Future The Glass Is Half Full

This is an exciting time to be returning to Fort Knox, and I want to say how happy I am to be here. My arrival coincided with the 1992 Armor Conference, in the first week of May, a gathering that set the tone and laid down the challenges for our future Army while focusing on our most effective weapon system, the Armor/Cavalry soldier.

It was a timely focus. In many ways, we are at a crossroads. True, there will be fewer Armor/Cavalry soldiers in the Army's future, and the load is always greater when fewer men must carry it, but on the other hand, we go into the future with certainties we didn't have a few short years ago. We know our training works; it's battle-proven. We know our weapons work. The Gulf War validated our strategy and tactics, too. And as monolithic Communism splintered and decayed, it became more and more apparent that the kinds of wars we once feared and trained for would be increasingly unlikely. While we don't know what kind of conflicts will take the place of the Cold War, or what these conflicts

will demand of us, there is a sense of confidence across the force that, come what may, we will be ready.

The war also reminded our political leaders and military planners that new threats can develop quickly in smaller nations that are quite capable of putting very sophisticated armies into motion, threatening our interests, and that it will take more than lightly armed contingency forces to deal with these threats. While heavy forces are expensive to equip and train, they are essential in a world where every tin-pot dictator has armor of his own and the will to use it. To break this will, our nation must have the threat of deterrence in kind, and this means heavy armor and well-trained crews. That dictator must know, as a certainty, that if he threatens our interests, we'll be making a visit.

Here in the Armor Force, we don't know when this will happen, and we don't know where. We don't have a lot to say about whether we go to war. Our focus is tighter. Our focus is to prepare, and in a smaller Army, that preparation will be harder. Each man carries a heavier load. And preparing

heavy forces for war is the most difficult task because of the need for teamwork and coordination. Crews, not individuals, fight tanks, and the crews must train together, know each other's strengths and weaknesses, know their machines. When it works, it is magnificent and irresistible. When it works, a good crew is more than a match for a poorly trained enemy tank platoon; a great platoon more than a match for a company of unmotivated, poorly led enemy tankers. Great crews are THE combat multiplier.

Our job here is to make this training happen, despite force cuts and budget trimming, despite uncertainty about the kind of combat we will face, who we will fight, or where it will happen. If you have a good idea about how we can stretch our training dollars, how we can do more with less, how we can make our downsized force more effective, don't keep it to yourself. In many ways, we are all experts about what we know best. My door — and my mind — is open. Visit, write, fax, or phone. We have a job to do.

# A Tale Of Two Battles:

*Victorious in Iraq  
An Experienced Armor Task Force  
Gets Waxed at the NTC*

by First Lieutenant (P) John A. Nagl

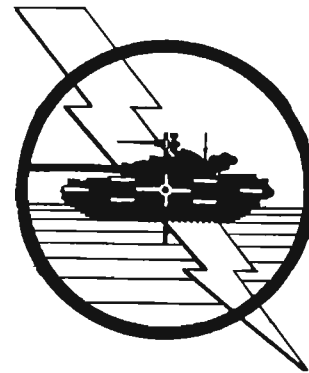

the enemy used against us, and the outcome of the battles could hardly have been more different.

## Operation Deep Strike

From February 15 to 19, 1991, the Blackjack Brigade of the First Cavalry Division conducted a number of border raids and ambushes against Iraqi positions in the Wadi al Batin in an attempt to convince the Iraqis that the main thrust of the Allied attack would come up this historic approach. These attacks were intended to cover the movement of the VII and XVIII Corps westward, to confuse the Iraqis as to Allied intentions, and to fix as many Iraqi forces as possible in place

## Introduction

Task Force 1-32 Armor, part of the 2nd (Blackjack) Brigade of the First Cavalry Division, has fought in both Operation DESERT STORM and at the National Training Center in the course of the past year. Much of the fighting was against dismounted infantry, and offers a number of lessons to those interested in armored warfare. The purpose of this article is to compare two battles in which the task force fought — one in Iraq, one at Ft. Irwin — and to draw from these battles several crucial points about fighting dismounted infantry with tanks.

Task Force 1-32 Armor (Bandits) is a combined arms maneuver battalion (CAM-B) permanently task-organized with a mechanized infantry company (Charlie Company) replacing one tank company. It is otherwise organized according to standard armored battalion MTOE. Equipped with M1 Abrams tanks and M2 Bradley armored fighting vehicles before its deployment as part of Operation DES-

ERT SHIELD, the Bandits replaced their old vehicles with new M1A1s and M2A2s while in Saudi Arabia (The scouts' M3s were not replaced). At Ft. Irwin the task force drew M1A1s and M2s, so the weapons systems with which we fought were similar in both battles. The terrain, the mission, the weapons systems which

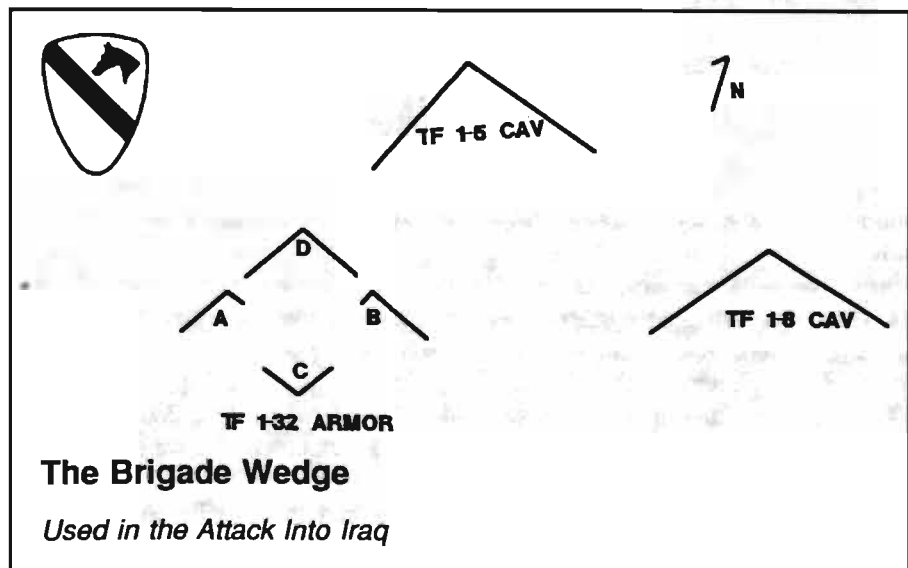





## Saddam's Ramparts of Sand



The tracks of passing wheeled vehicles give some sense of the size of the Iraqi fire trench, at upper left.



At left, detailed view of an individual fighting position, bolstered by sandbags and ammo boxes.

At right, individual fighting positions were connected by a network of slit trenches.

so that they could be taken from the rear by the main attack from the west. The culminating attack of the deception took place on 24-25 February, as the entire Blackjack Brigade attacked across the berm separating Iraq from Saudi Arabia and moved to contact.

Moving in standard brigade wedge on the morning of 25 February, Task Force 1-32 Armor protected the western side of the formation. The task force was aligned in a diamond, with Delta leading in a wedge, Alpha on the left flank in echelon left, Bravo on the right in echelon right, and Charlie Mech trailing in a vee formation. The Bandits' mission was to find a bypass through the minefields and fire trenches which protected dug-in Iraqi forces to our north by 1230 hours, or to withdraw after creating a successful diversionary attack.

Coalition forces to the brigade's eastern flank reported significant difficulties breaching minefields and trenches filled with oil that the Iraqis lit to create smoke screens. The task force encountered an antitank mine-

field and breached it in stride with mineplows, suffering one loss as D34 detonated a mine which a plow

missed. (No crewmen were injured, and the tank returned to action within 24 hours.) A-10s and MLRS fought

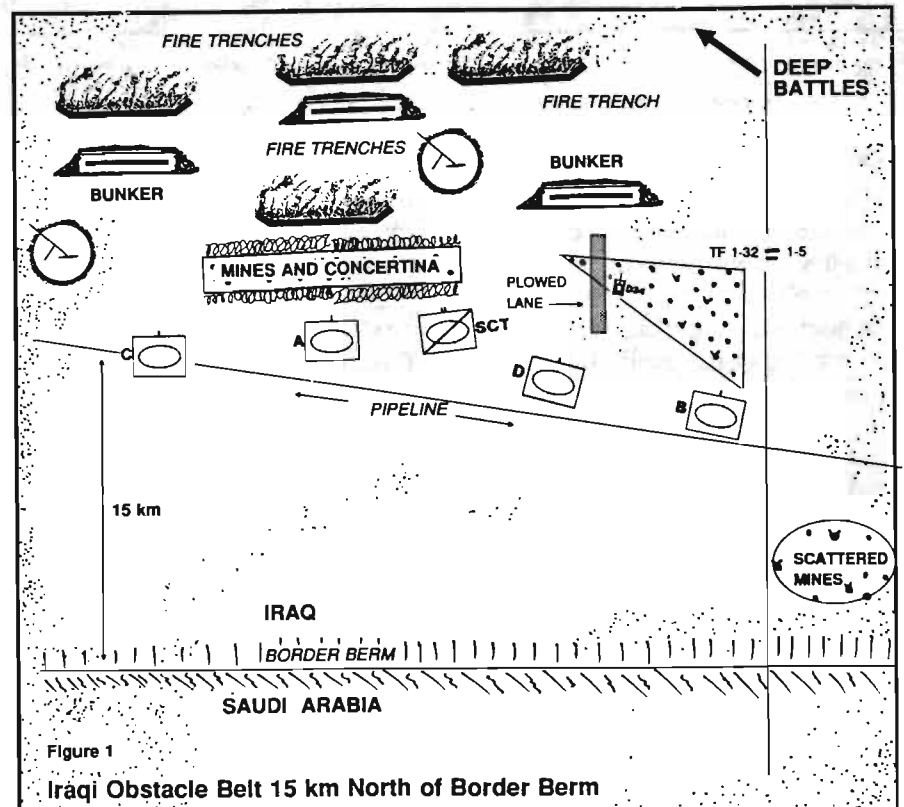

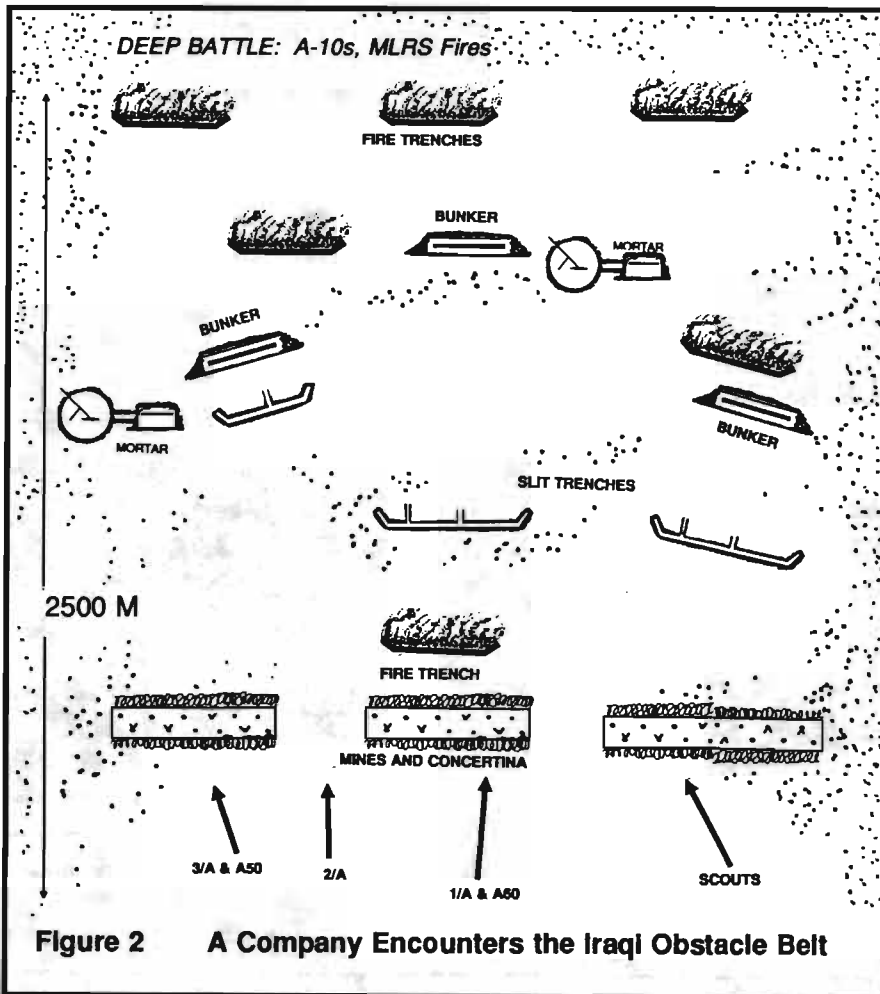

**Figure 2 A Company Encounters the Iraqi Obstacle Belt**

the deep battle as the task force came on line and began engaging numerous dismounts entrenched in fighting positions with small arms and HEAT rounds. Frustrated by fire trenches protected by minefields, the tank and Bradley commanders put their hatches in open protected position to protect themselves against the small arms and mortar fire of the Iraqis. Tankers, unable to range the Iraqi positions with coaxial machine guns, fired HEAT rounds to destroy bunkers and mortar positions and adjusted fire with the tank commander's .50 M2 by watching the impact of the rounds through the Thermal Integrated Sight (TIS). Indirect fire filled the void, as the First Cavalry Division's 3-82 Field Artillery fired more than 1000 rounds, and the battalion mortars fired 129, getting target effect on a number of dismounted positions. At 1230 hours,

the brigade was ordered to withdraw back through the berm to Saudi Arabia, but the deception mission was a complete success; it froze an entire Iraqi Corps in place, and helped ensure the success of the VII Corps left hook around the Iraqi defenses.

### **Task Force Destroyer and the Battle of Tiefert Spur**

Almost a year to the day after Task Force 1-32's battle against Iraqi infantry during Operation DEEP STRIKE, the task force found itself in battle against a much more determined and better-equipped foe: the Krasnovians of the National Training Center. On February 14, 1992, Task Force 1-32 Armor received the mission to defend the Whale Gap and the Valley of Death against a Krasnovian regiment equipped with T-72 and some T-80

tanks, BMP-2 Infantry Fighting Vehicles, and infantry armed with effective antitank guided missiles. The task force deployed in a rough semicircle designed to prevent enemy penetration and mass fires along both possible enemy avenues of approach. Alpha Company was nestled against the foothills on the south of Tiefert Mountain, Charlie Company tied in to the Tip of the Whale, with Delta on line between the two flanks, and Bravo behind them in reserve. Alpha and Charlie had exchanged their third platoons, so that Alpha Team had two platoons of tanks and one of mechanized infantry to help protect against an expected dismount threat from the north over Tiefert Mountain.

Priority of engineer effort went to Delta and Bravo, exposed along the southern edge of Siberia and expected to face the brunt of the Krasnovian attack as they drove north and east toward the Big Sandy Wash and Red Pass. However, it was Alpha Company which would do the fighting — and the "dying" — on the night of February 15.

The fighting began at about 2100 hours with Alpha deployed in a line, tanks backed into wadis against the foothills. Nine of the ten tanks were operational, but the platoon of Charlie Company was down to two vehicles because of maintenance problems. Worse, those two Bradleys had gone to guard John Wayne Pass to prevent an attack into the task force rear area. This left the nine tanks of Alpha Company alone to guard against an expected enemy reconnaissance effort east along the Valley of Death and exposed to infantry attack down the slopes of Tiefert Mountain.

Alpha succeeded in defeating the enemy reconnaissance effort, destroying a total of four BMPs and four BRDMs that snuck in and out of the

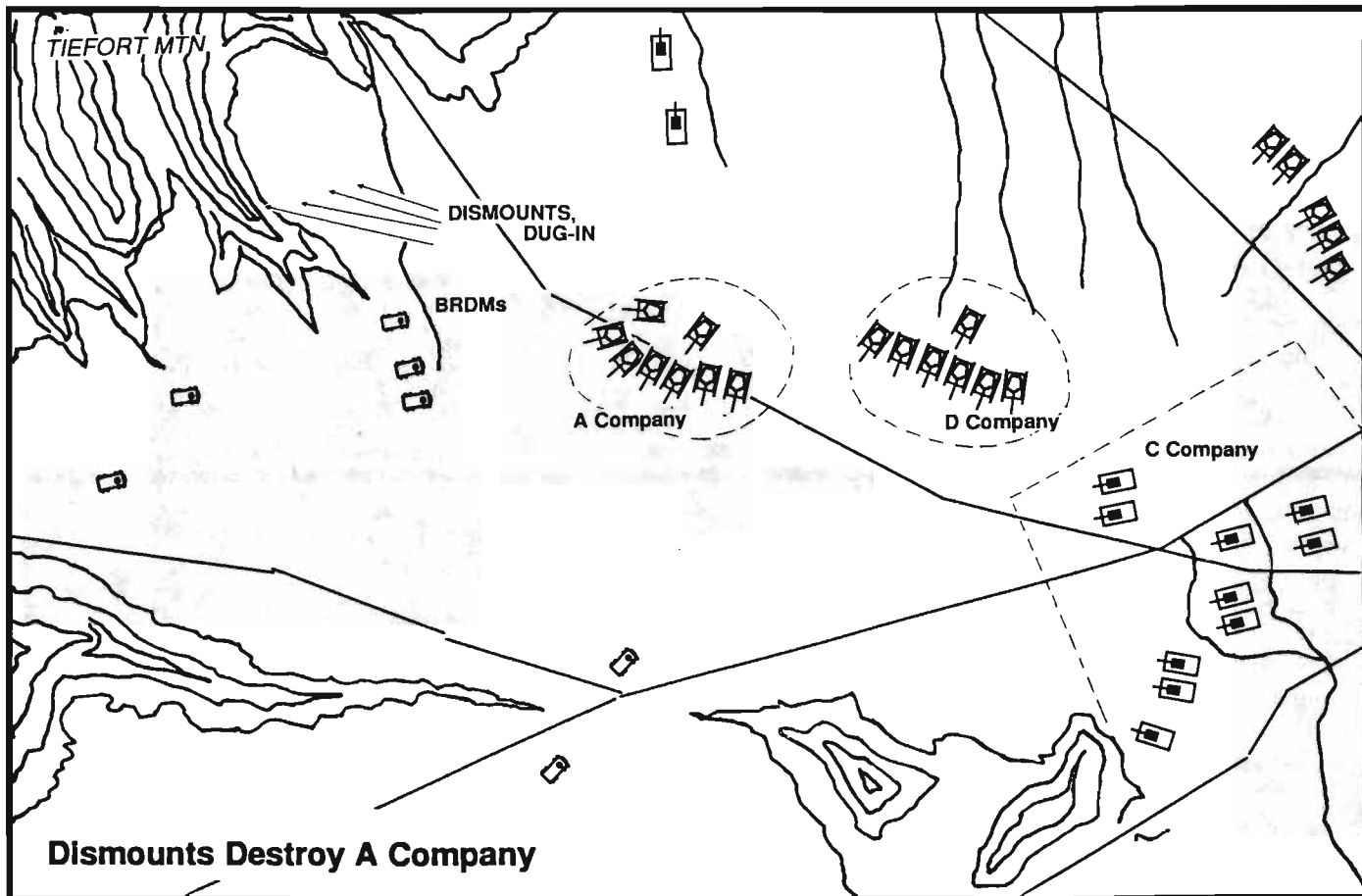

wadis as they attempted to gain information on the disposition of the task force. However, the company began to see dismounts creeping down Tiefert Mountain to its rear at approximately 2300 hours. Engaging the troops with coax and indirect was largely ineffective, as the enemy took up hasty defensive positions among the rocks. Repeated calls for fire killed many of the dismounts, but they continued to advance, and one of the two Bradleys was called back from John Wayne Pass to help protect the company. Charlie Company, 8th Engineers bravely dug in the nine tanks from 2200 to 0100, even as the covering force battle and the fight against the enemy infantry were taking place. Alpha tanks used their superior night vision capability to direct the Bradley against known enemy positions, and task force mortars fired a number of

accurate missions until their ammunition was completely expended, but most of the enemy infantry managed to survive.

At approximately 0300 hours, the Krasnovian infantry began using illumination to spotlight the westernmost Alpha tanks, now dug in and still searching for enemy reconnaissance elements to their west and south. The Krasnovians deployed hunter-killer Dragon teams in groups of three and four against individual tanks at close range. The tanks, having exhausted their small arms ammunition, called for fire on their own positions, but were overwhelmed one by one as the enemy infantry rolled up Alpha's flank from west to east. Only two of the nine Alpha tanks escaped by abandoning their prepared battle position and fleeing southeast. The Krasnovian infantry had defeated an

M1A1 tank company in detail and rendered it combat ineffective.

### Lessons Learned

Task Force 1-32 Armor faced a mostly dimounted threat in two battles separated by only a year in time, but worlds apart in terms of mission, terrain, enemy situation, and results. The task force was fortunate that the Iraqis it fought in Operation DEEP STRIKE did not have effective anti-tank weapons, had not emplaced them in overwatch positions protecting their well-designed obstacle, and did not have effective indirect fires available to place on the obstacle.

A year later, fighting a more determined and better armed foe, Task Force 1-32 Armor had one of its tank companies decimated by a light infantry company of approximately 150

men. The Battle of Tiefert Spur demonstrates how effective good infantry can be against tanks that are not prepared to fight dismounts. The contrast between the two battles offers us several lessons:

- Infantry presents a very real threat to tanks. We don't train to fight this threat enough. Talks with the observer-controllers at the NTC confirmed that one of the biggest killers of tanks at the NTC is infantry fighting dismounted. The Battle of Tiefert Spur is a regular feature of NTC rotations; the observer-controllers call the OPFOR infantry company "Task Force Destroyer" and told us that fighting the dismounts in this situation is the hardest task the NTC presents to a tank company.

- The best way to defeat infantry is with infantry. Task Force 1-32 Armor is permanently task organized with an infantry company, yet did not use its infantry as effectively as it could have in DESERT STORM or at the NTC. Tank companies need to work with infantry units on a regular basis to establish SOPs and to learn each other's strengths and weaknesses. Without infantry to protect tanks from enemy dismounts, a lot of tanks will get killed.

- Infantry doesn't have to be spectacularly well trained to present a real threat to U.S. Armored Forces. The company commander of the Alaska National Guard Cavalry company which defeated Task Force 1-32 Armor at the battle of Tiefert Spur (and earlier that week at the Battle of Red Pass) told me that his soldiers had seen a Dragon for the first time only three weeks before they fought us. They learned fast, but so may the next enemy that fights the United States with advanced antitank weapons. Kudos to the soldiers of the Alaska National Guard, who im-



pressed all of us who fought against them with their professionalism, enthusiasm, and performance.

- Tanks need dedicated indirect fire support on board. The experience of fighting infantry on two different battlefields in less than a year highlights the need for a weapons system like the Mark 19 Automatic Grenade Launcher to defeat infantry at extended ranges, even when they are dug in. (See the excellent article by CPT Andrew Harvey and SFC Robert Firkins in Sept/Oct 1991 *ARMOR* for details.) We found 120-mm HEAT rounds to be an effective bunker-buster in Iraq; however, that is an expensive solution to the tactical problem. Our experience has demonstrated that tankers are at least as likely to fight dismounts as they are to fight tanks; tanks need a weapons system that will allow them to defeat dug-in infantry at ranges beyond the killing radius of hand-held antitank weapons systems.

- Indirect fire support of armor units is essential, and training shows results. Tank commanders and even tank loaders called for fire at the NTC, largely due to extensive use of the Observed Fire Trainer before our NTC rotation. Tank units must train

all of their personnel to accurately call for and quickly adjust indirect fire.

These are just a few of the lessons Task Force 1-32 Armor learned as it fought dismounts in the deserts of Iraq and California in the last year. They are presented here in the hope of inspiring further debate in the Armor community over how to best deal with the threat that determined, well-armed dismounts present to an Armor Task Force.

First Lieutenant (P) John A. Nagl is a 1988 graduate of the U.S. Military Academy and received a Master's Degree in International Relations from Oxford University. A graduate of the AOBC, Airborne, Air Assault, and Tank Commander Certification Courses, he served as 1st Platoon leader of A/1-32 Armor, 1st Cavalry Division during Operation DESERT STORM, and as XO of the same company during NTC Rotation 92-4. He is currently attending AOAC.



## Dragon's Roar:

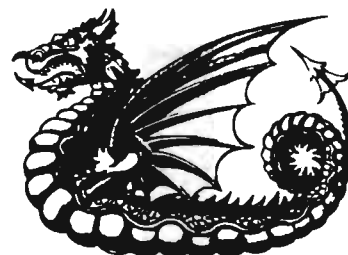

### 1-37 Armor in the Battle of 73 Easting

by Second Lieutenant Richard M. Bohannon

Virtually all branches of the U.S. Army generated lessons learned as a result of Operation DESERT STORM, particularly Armor. The ideal tool for desert combat, Armor met with extreme success in Iraq and Kuwait. With the lessons we learned there, we have the potential to be even more successful, not just in the desert, but in any environment.

One battle, in particular, showed us — the 1st Battalion, 37th Armor Regiment — a score of strengths, as well as areas for improvement. On the night of February 26, 1991, we fought against the 29th Brigade of the Iraqi Tawakalna Division in what we now call the Battle of 73 Easting (or the Battle of the Tawakalna). The Tawakalna, part of Saddam Hussein's Republican Guard, was established in a blocking position in an attempt to allow retreating Iraqi forces to their rear an escape to the north. It turned out to be a costly attempt for the Iraqis.

Much thought went into the organization of 1-37 Armor prior to that night battle. When we arrived in theater in December 1990, Battalion

Commander LTC Edward L. Dyer made the decision to exchange some equipment with theater reserve in order to better equip our scouts and first sergeants for their missions. The scouts initially had three M113 APCs and three M901 ITVs. We turned in the ITVs and in return drew six HMMWVs from theater reserve. These six HMMWVs, plus the first sergeants' HMMWVs from B, C, and D companies, were given to the scouts and organized into three sections, each with three HMMWVs. Each vehicle had an M-60 machine gun mount and a crew of three scouts, one with an M16A2 rifle, one with an M203 grenade launcher, and one manning the M-60. Thus organized, the scouts had a lower profile and were better suited to provide intelligence to the commander and to avoid decisive engagement with the enemy. Each of the first sergeants in companies B, C, and D then received an M113 APC, providing them with armor protection on the battlefield.

It also became apparent that the M577 was an unsuitable vehicle for a TOC during offensive operations.

TOC personnel found they could operate more efficiently out of a HMMWV with lapboards. They used the battalion commander's vehicle, which had a three-net capability.

In early February 1991, 1-37 Armor reorganized into an armor heavy task force. We exchanged A/1-37 Armor for C/7-6 Infantry. LTC Dyer chose not to task-organize further into company teams, because, if we had to clear trench systems of large numbers of dismounted troops, he wanted our infantry concentrated under one command.

On the afternoon of February 26, TF 1-37 advanced east as the right flank task force in the 3rd Brigade wedge, and as flank task force for 1st Armored Division. TF 7-6, a balanced task force, led the brigade, and TF 3-35 covered the left flank. Our mission was to attack in order to destroy the Republican Guard Medinah Division at Objective Bonn. At about 1600, we received in-flight reports from the brigade's air scouts who spotted about fifty tanks and other vehicles in revetments along our axis of advance 35 kilometers west of Objective Bonn. We obtained six-digit grids that outlined their battle position and distrib-

uted this information down to tank commander level.

The discovery of such a large and previously undetected enemy force in our sector came somewhat as a surprise. Before the ground war began, our S2 kept us informed daily of all shifts of major units, BDA inflicted by the Air Force, and other pertinent information. His sources included Air Force reports that were usually less than 24 hours old, and aerial photographs that enabled him to template enemy positions down to individual vehicle fighting positions. Our superior intelligence gave us an enormous advantage on February 25 in our fight with the Iraqi 26th Infantry Division, and in 1st and 2nd Brigades' Battle for Al Basayyah. For both of those battles, all vehicle fighting positions, bunkers, buildings, and obstacles were templated and exact numbers of vehicles known.

Before Operation DESERT STORM, the Tawakalna had been templated about fifty kilometers northeast of their position on February 26. They had recently moved out of the northern position, making our previous information inaccurate.

The enemy's new templated position straddled the operational boundary between 3rd Brigade, 1AD, and 2nd Brigade, 3AD (Map 1). USAF A-10 strikes pummeled the position, and 2nd Brigade, 3AD began to attack with artillery and illumination in its sector to the south. Third Brigade approached to within 10 kilometers of the position.

Visibility worsened, due to a sandstorm mixed with rain. Thermal sights effectively cut through the haze, but identifying vehicles by type beyond 1500 meters was virtually impossible.

#### 1930-2000

Direct support artillery (3-1 FA) began to prep the enemy's position in 3rd Brigade's sector using 155-mm DPICM. The brigade changed to a

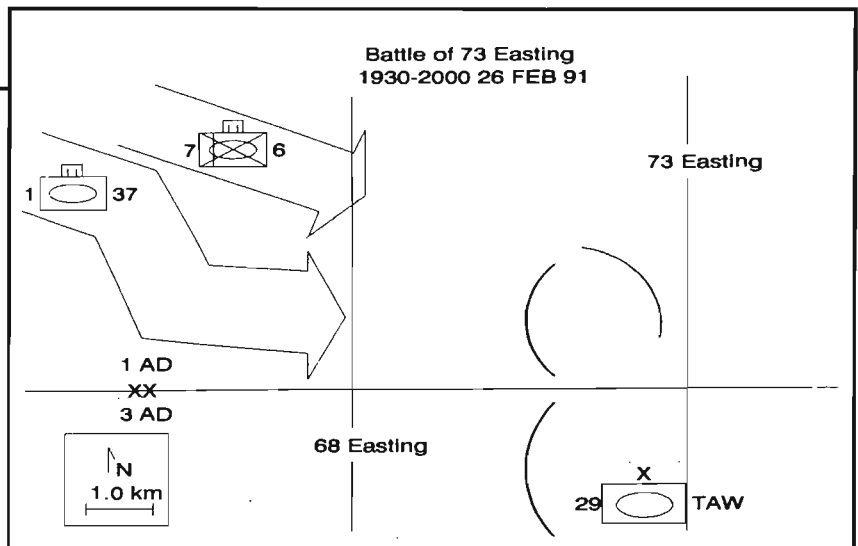

**Map 1**

"The enemy's new templated position straddled the operational boundary between 3rd Brigade, 1AD, and 2nd Brigade, 3AD."

line formation, bringing TF 1-37 up with TF 7-6. TF 3-35 remained in the rear as the brigade reserve. In addition, Task Forces 1-37 and 7-6 both brought their teams/companies on line. TF 1-37's scouts moved to the right flank to screen and maintain coordination with 3rd AD. Enemy dismounted troops to the front opened fire with machine guns but were ineffective. TF 7-6 responded by engaging enemy vehicles at long range with Bradley-mounted TOWs.

#### Comments

Throughout the war, direct support artillery and close air support were effective weapons for the deep attack. In desert environments, we must be prepared to use these assets primarily at brigade level. Of course, we will continue to train artillery call-for-fire, at least down to the tank commander.

One cannot overemphasize the value of rehearsal. Days of battalion-level battle drills in the sandstorms of Saudi Arabia paid immense dividends in Iraq. Even before the ground war began, we were accustomed to operating at night and in bad weather, with few halts and no terrain features to guide on.

Combat leaders must be skilled navigators, but even the most expert navigator had little chance of knowing his location, calling accurate indirect fire, or reporting enemy locations and obstacles in the unchanging nothingness

of southern Iraq. Therefore, we had to use GPS (Global Positioning System) and LORAN (Long-Range Navigation) devices. All together, TF 1-37 had 26 individual navigational devices. Three went to each tank company, six to the infantry company, four to the scouts, and one each to the mortar FDC, the TAC, TOC, LNO, S4, S3, and battalion commander. We had an adequate number of devices, considering the openness of terrain and the ease of guiding on someone who was navigating with a LORAN or GPS.

Such systems would even have value on European terrain, expediting and providing greater accuracy for maneuver, indirect fire, and reports. In Operation DESERT STORM, there was no need to distribute the devices down to tank platoon leader level, but in Europe, we should because of the increased probability that tank platoons will operate out of visual contact of someone with a LORAN or GPS. If such systems do become more widely available, leaders must remember that a GPS is not a substitute for traditional methods of navigation. We

should continue to stress standard land navigation techniques.

### 2000-2030

TF 7-6 was set at the 68 North-South grid line, oriented toward the enemy position 2.5 kilometers to the southeast (Map 2). TF 1-37 was on TF 7-6's right flank, orienting directly east on the same position. TF 1-37's combat trains were at the 63 grid line, five kilometers to the west, while company combat trains continued to trail the companies.

Meanwhile, the pace of the fight began to accelerate. D/1-37 observed enemy troops 900 meters to its front advancing in 3-5-second rushes, and destroyed them with coax. TF 7-6 and TF 1-37 reported additional troops and vehicles at 2000-4000 meters. They destroyed these targets with coax, TOW, 25mm, and tank main gun fire. Four unidentified vehicles fled to the east of the enemy's position and were not engaged, due to the extended range (4.0-4.8 kilometers). Meanwhile, 2nd Brigade, 3rd AD began a ground attack in the adjacent sector to the south.

Direct support artillery ceased fire on the objective, while MLRS rockets began hitting deep targets to the east. Third Brigade called OH-58Ds forward to determine battle damage, and TF 7-6 fired illumination rounds to improve surveillance of the objective.

### Comments

The Bradley has proved to be a capable weapon system. Not only was its TOW an effective tank killer, but its 25-mm gun was also capable of destroying or disabling most Iraqi tanks and PCs.

After the battle, we discovered that our artillery did not hit the intended

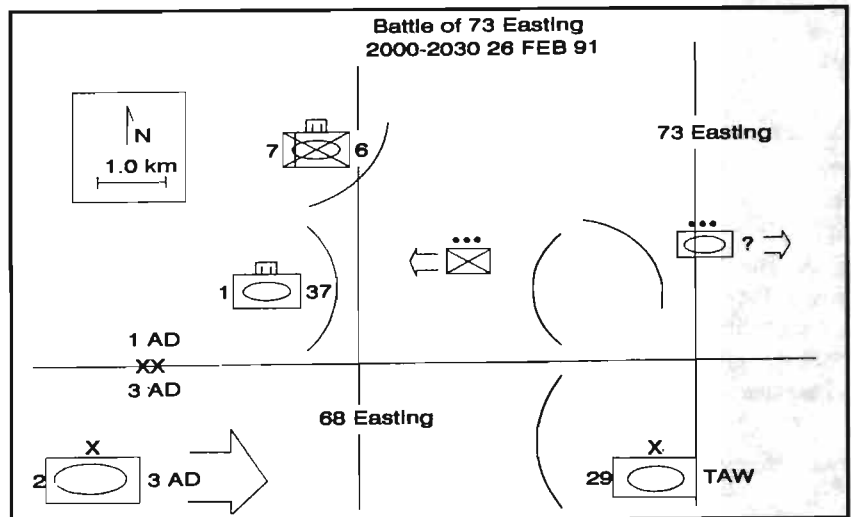

Map 2

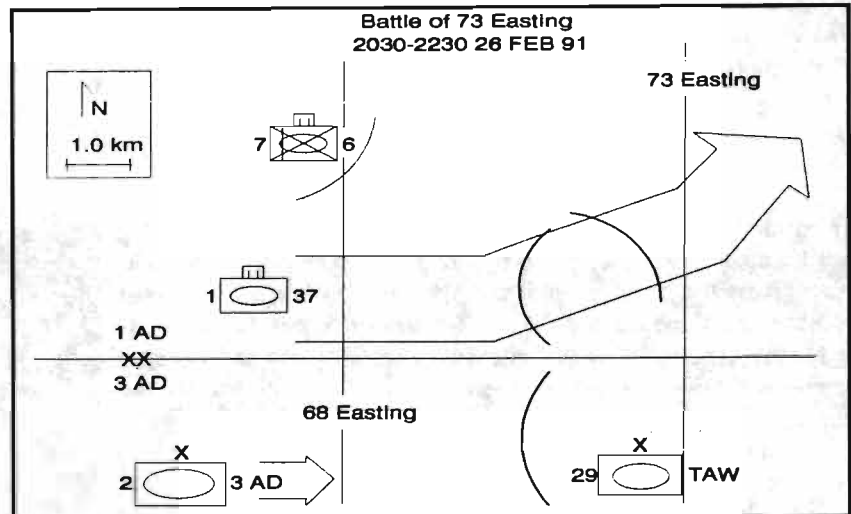

Map 3

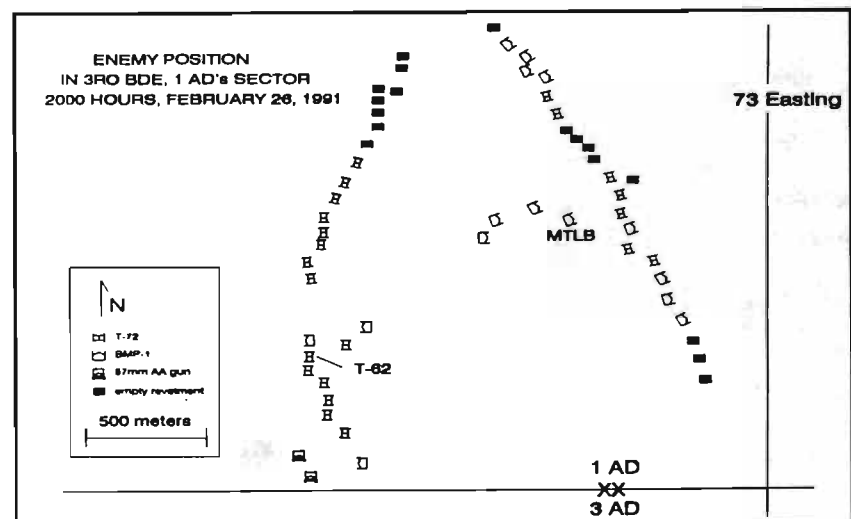

Map 4

*"The artillery strike was effective psychologically. During the strike, the Iraqis believed they were under air attack, fled from their vehicles, and sought shelter in their underground bunkers. Most didn't realize they were under ground attack until it was too late. Many were killed by direct fire as they attempted to remount their tanks."*

target. In fact, the entire barrage struck an empty area of desert several hundred meters beyond the enemy positions. The difficulty of gauging distance in the desert, in addition to the poor visibility conditions, made artillery range adjustment difficult. Nevertheless, the artillery strike was effective psychologically. During the strike, the Iraqis believed they were under air attack, fled from their vehicles, and sought shelter in their underground bunkers. Most didn't realize they were under ground attack until it was too late. Many were killed by direct fire as they attempted to remount their tanks.

#### **2030-2100**

Third Brigade Commander COL Daniel Zanini instructed TF 1-37 to sweep across the objective and halt 3 kilometers past the far side. TF 7-6 would lift fires and remain set in overwatch (Map 3). 1-37's company trains and TOC would also remain set as the tanks advanced on line. The infantry company followed 1000 meters to the rear of the tanks in order to police up any troops the tanks missed. We advanced at a slow 5-10 kph rate. By 2100, at least eight enemy vehicles were burning.

#### **Comments**

Forty-five tanks assaulting on line can wreak havoc on the enemy, but are difficult to control during limited visibility and combat conditions. We had rehearsed this play, known to us as "Dragon's Roar," several times in Saudi Arabia, and we used it in our battle with the 26th Infantry Division on February 25. These experiences greatly simplified execution during the battle, as did continual cross-talk between companies and platoons.

Some commanders opted to use a company command-directed nets, rather than platoon nets, and in some cases this expedited command and control. In other cases, it merely added to the confusion. When using a company command-directed net, if individual tanks encounter problems or observe something that other tanks do not, you have the potential to have 14 or more people on one net, and command and control is lost.

On the other hand, if an operation is simple enough that a lot of feedback is not expected, a command-directed net will allow the commander instant access to each crew, speeding information flow and response to his order. The commander must carefully assess his unit and the specific situation before he decides to use a command-directed net.

Another measure we took to facilitate command and control was to use filtered light. While in Saudi Arabia, we removed taillight covers on all vehicles, mounted colored flashlight filters on the inside, and remounted the covers. The lights served not only to identify a vehicle's location, but its unit as well (the color of one taillight identified the vehicle's brigade; the other, its battalion). More than one filter was used for each taillight, in order to make them almost invisible to the naked eye, but they appeared as bright as a beacon with night vision devices. One company took the idea a step further and stacked filters in their flashlights until the light was invisible to the naked eye but visible with PVS-7s. They

could then use the flashlights for signaling.

#### **2100-2130**

The attack continued toward the east. To our front we faced dismounted troops in trenches and numerous armored vehicles in defilade, consisting predominantly of T-72s and BMP-1s. We fired at most of the vehicular targets at ranges of 2200-2800 meters, but engagements beyond 3000



BMP-1 armor proved no match for M1A1 or Bradley fire.

meters were not uncommon. One M1A1 on the move hit a BMP with a HEAT round at 3250 meters. The longest shot with a confirmed kill was 3750 meters. The Iraqis returned fire, chiefly with small arms and machine guns, but also with T-72 main gun and/or dismounted antitank missile teams. Apaches joined in the fight off the flanks of TF 1-37. Five dismounts surrendered to D/1-37.

#### **Comments**

There were a lot of gunnery lessons here. First, because one of the M1A1's advantages is its stand-off ca-



pability, we should consider long-range gunnery training. Our current tank gunnery tables are adequate training for European terrain and should be retained. However, we need to add long range tables specific to desert gunnery. In addition, we need to incorporate high fidelity friendly targets into gunnery and penalize tanks that shoot them.

AFV identification definitely was difficult. Gunners could easily acquire targets, but could rarely identify vehicle type past 1500 meters. Part of the problem was the sandstorm, but many soldiers pointed out that we need sights with higher magnification. The M60-series tank had a 13-power sight, and the M1A1 definitely has a higher quality fire control system than the M60. A 20-power sight would be ideal. This, or an IFF (Identify Friend or Foe) system, would greatly assist us.

The M1A1's fire control system dominated the battlefield. Boresights held for 300 kilometers of travel with only MRS updates needed. Despite the non-stop nature of operations, very few fire control systems malfunctioned. Even our main gun ammunition appeared quite sophisticated when compared with the pig-iron sabot rounds the Iraqis used. We had no problem knocking the turrets off T-72s almost every time.

In the offense, gunners should be in charge of the turret, acquiring and engaging targets, while the TC controls his vehicle or subordinate unit. If tank commanders and platoon leaders spend too much time looking through their GPSEs, they get tunnel vision and can't see where their tank or platoon is going in the big picture. During defensive operations, the TC will have more opportunity to assist the gunner with acquiring and laying the gun on targets, but on the move, the



One of B Company's M1A1s hit by enemy fire awaits recovery.

TC must keep his attention on the overall situation.

Lastly, the concept of the "fighting XO" worked. Keeping the company XO forward and talking to the task force commander, while the company commanders stayed on their internal nets, proved effective.

#### 2130-2200

We fought a close battle on the objective. As we maneuvered around burning vehicles and bunkers, we lost four tanks to enemy fire. The first was D-24, which was struck in the left side. The explosion killed the engine and injured the loader and gunner. Tank Commander SFC Anthony Steede immediately began the evacuation of his crew. On the ground, he maintained radio communication via an extra-long CVC cord. While Gunner SGT James Kugler led the men to the safety of another tank, SFC Steede remounted the vehicle and attempted to restart it. Unfortunately, the engine was severely damaged and he was forced to abandon the tank.

At about the same time, a tank from Company B took a hit in the rear. The engine quit, and all power controls ceased to function. Tank Commander SGT Christopher Rhett said later, "From my perspective I knew it wasn't a mine. It definitely felt as though we were hit."

SGT Tracy Sells, the gunner, added, "It rattled our cages. In fact, it

knocked the TC and loader up in the air and back down again."

As a precaution, the crew immediately engaged the Halon fire extinguisher system, which put out any existing fire.

Suddenly, the tank was struck again. The crew evacuated and took cover about 50 meters away as the tank caught fire. Eventually, they were able to flag down a passing tank from Company D for assistance.

On the right flank, Company C had problems of its own. The first tank hit, C-12, was disabled, but the crew escaped uninjured and took cover under the front slope. Nearby, 1st Platoon leader, 2LT Albert Alba, saw the explosion and made his way to the scene. He directed suppressive machine gun fires on the suspected enemy position and, upon spotting an undamaged BMP-1 in the immediate area, destroyed it with a sabot round. His loader, PFC Michael Hamouz, dismounted and ran to C-12 to offer assistance.

Suddenly, the company commander's tank, also in the area, was struck. As the crew attempted to dismount, the tank was hit by a second round, throwing the commander and his loader from the turret to the ground. The crews from the two disabled tanks ran to 2LT Alba's tank. When all eight crewmen were safely on board, Alba hastily employed smoke, executed a Sagger drill, and left the area. He soon rejoined the rest of Company C to the east.

Upon hearing that the CO had been hit, 1LT Jeff Fuchs, Company C executive officer, immediately assumed command of the company until the commander's return, 20 hours later.

Secondary explosions of burning Iraqi vehicles threw shrapnel and other debris in all directions as pillars of flame rose to a ceiling of black smoke.

Virtually all enemy vehicles in the area were destroyed, but dismounted troops remained hidden in trenches and bunkers. Companies C and D both reported receiving small arms fire from their rear as they swept toward the east. Fortunately, physical clearing of the trenches wasn't necessary, the Iraqis surrendered in force and came forth voluntarily. But if the infantry had been ordered to dismount from its Bradleys to clear the trenches, and if our previous artillery attack had been on target, friendly forces would have had to contend with unexploded CBU's (cluster bomb units) and DPICM bomblets from air and artillery strikes, in addition to Iraqi bullets.

## Comments

Speculation continues concerning what shot our four tanks. The three most probable answers are T-72 main gun, dismounted antitank missile, or Apache-launched Hellfire missile. The fact that Apaches were operating to our rear and a witness's reports of high round trajectory support the friendly fire theory. However, ballistic reports suggest that 125-mm HEAT rounds produced the damage on some of the tanks. Visual examination of others reveals an obvious sabot hole. Overall, the physical evidence implies that T-72 fire took out our tanks, but the friendly fire possibility cannot be excluded.

The Abrams is a rugged tank. Within days, we recovered three of the four disabled M1A2s with an M-88 recovery vehicle. With parts we had on hand and enough time, two of those could have been driven off the battlefield. Only one of the tanks was a catastrophic loss.

More important, the Abrams is a survivable tank. After our four tanks were disabled by enemy fire, ten crew members emerged almost unscathed and the other six had non-life-threatening injuries.

One oft-discussed protective feature of the M1A1 that is worth mentioning is the commander's hatch. In the open-protected position it provided excellent protection against raining shrapnel while still allowing clear 360-degree visibility.

A combat lifesaver on every tank is a must. When we crossed the objective, our combat trains were still several kilometers to our rear. Without personnel immediately available to stabilize casualties, their status could have been much more critical.

We already train tank crew evacuation, but we also need to address actions after evacuation. Soldiers should have more than just their personal weapon and Kevlar when they hit the ground. Their rucksack should be packed so that the soldier can survive on his own for a period of days, and should be easily removed. In addition, an extra-long CVC cord should be hooked into one of the crew stations so that dismounted crews can main-



A "beheaded" T-72, destroyed by 1-37 AR at 73 Easting.



This T-72, with mine plow, also lost its turret.



M1A1 fire blew off the deck of this BMP-1.

tain radio communication without remounting the tank and drawing enemy fire.

Lost leader drills proved their worth to Company C. They should be incorporated into all field exercises.

Finally, the use of DPICM and CBU use must be addressed in the operations order. Due to the large number of unexploded bomblets, an area attacked with DPICM or CBU's should be considered a minefield capable of killing dismounted troops and disabling wheeled vehicles. We must take great care when considering the use of DPICM or CBU in the attack, as this may preclude or make more hazardous the use of dismounted infantry to clear the objective.



*"Our biggest problem was transport to the rear. We put prisoners in whatever was available: Bradleys, trucks, scout HMMWVs, engineer M113s, even ACE buckets."*

### 2200-2230

Iraqi troops surrendered in large numbers to our infantry, and soon we had over 100 EPWs. 1-37's combat trains rejoined the tanks to the east and MEDEVAC procedures commenced for casualties.

### Comments

Commanders need to consider command and control of the combat trains when separated from the line platoons. In addition, first sergeants don't need to be on the battlefield in HMMWVs; they should have armored vehicle protection.

EPW operations need more thought. Our biggest problem was transport to the rear. We put prisoners in whatever was available: Bradleys, trucks, scout HMMWVs, engineer M113s, even ACE buckets.

### Conclusion

At 2300, the infantry reported the area clear, and at 0050 the next morning, the brigade reformed and continued the attack east. Final BDA for TF 1-37's sector of the Battle of 73 Easting included 21 T-72s, 14 BMP-1s, two 57-mm AA guns, one T-62, and an MTLB destroyed, and over 100 EPWs. Our personnel status was zero

KIA, zero MIA, six WIA. TF 1-37 added two more successful battles to its history by February 28th. When the war ended, we found ourselves a few kilometers inside liberated Kuwait.

We can attribute the success of 1-37 Armor, and the U.S. Army in Operation DESERT STORM, to many things, not the least our flexibility and ability to adapt training and other operations to ever-changing situations. We must apply lessons learned from DESERT SHIELD/STORM to current training if we want to maintain an advantage on the battlefield because, next time, our enemy may not give us time to train in his backyard.



In March 1991, the officers of 1-37 Armor had a chance to go back over the 73 Easting battlefield to conduct officer professional development and discuss lessons learned.

Second Lieutenant Richard M. Bohannon is a 1990 Distinguished Military Graduate of Texas A&M University, and holds a B.S. degree in Biochemistry. He is also a graduate of the Army Airborne School and the Armor Officer Basic Course. During Operation DESERT SHIELD/STORM, he served in Saudi Arabia, Iraq, and Kuwait with 1-37 Armor as a M1A1 tank platoon leader. Since then, he has been a liaison officer for 1-37 Armor and is currently the executive officer for HHC, 3rd Brigade, 3rd ID, Germany.



At the eve of World War II, U.S. airborne troopers trained to use bicycles. In photo above, a trooper fires his then-modern M1 Garand rifle from prone position in training at Fort Benning.



Thousands of Harley-Davidsons served during WWII.

## Tactical Employment of the Military Motorcycle

by Lieutenant Colonel Craig S. Harju, Sr.,  
Sergeant First Class David F. Wilson,  
and Richard B. Armstrong

The necessity for speed and flexibility on the modern battlefield poses a unique challenge for the cavalry scout. Although his primary missions are reconnaissance and security, the scout may also facilitate unit movement, provide liaison between units, and restore communications. A scout section or even an entire platoon may perform these duties.

However, one or two mounted scouts often can perform the job just as effectively and even more efficiently in terms of personnel resources. To accomplish these duties, the scout needs a vehicle with excellent cross-country mobility, agility, and speed — such as the military motorcycle.

The origin of the military motorcycle can be traced back to the Franco-Prussian War of 1870 in which bicy-

cles, the forerunner to the motorcycle, were used to carry dispatches. The U.S. Army formed the 25th Infantry Bicycle Corps in 1896 and continued to use bicycles through the early 1900s.

With the introduction of small efficient gasoline engines, the bicycle evolved into the motorized bicycle, or motorcycle. The Army's interest in motorcycles increased dramatically with the outbreak of World War II. In early 1940s, the Army purchased Harley Davidson and Indian motorcycle models. Armored units used the Harley Davidson WLA, a military version of the commercial model featuring a 45-cubic-inch engine. Harley Davidson produced the WLA motorcycle form 1940 through 1945 and from 1950 through 1952. Military histori-

ans such as Roy Bacon have noted that the World War II military motorcycle "played its part in all fields to carry messages, marshal convoys, police troops, and act as a mobile fighting unit."

Today, the military motorcycle (MILMO) is not currently a part of the Army inventory, although many cavalry units have acquired them through local purchase. There is also a proposal to add four motorcycles to the tank and mechanized infantry battalion scout platoon.

The primary purposes for tactically employing military motorcycles are to enable mounted scouts to conduct detailed reconnaissance, conduct security patrols, facilitate movement, provide liaison between adjacent units, and restore communications between units.



An extra hand might have been essential to this 1930s corporal of cavalry, at left, whose military motorcycle mounted a drum-fed Thompson submachinegun.

The "high-technology testbed" 9th Infantry Division trained with Kawasaki-based military motorcycles in the mid-1980s



In terms of reconnaissance, the scout platoon leader can use a motorcycle scout team to reconnoiter potential areas of interest before dedicating a BFV or other crew vehicle to that reconnaissance. However, a single motorcycle scout should never be employed beyond the line of sight of an overwatching vehicle or fellow scout. A mounted scout, while moving, is constrained by having to control his motorcycle and requires protection from enemy elements.

Motorcycle scout teams may also be employed to conduct security patrols. For example, they could patrol routes between observation posts that have been emplaced for extended periods of time.

A third use for the motorcycle scout is to facilitate a unit's movement. A

mounted scout may function as a guide during a passage of lines, relief in place, or other unit movement. Again, the use of the motorcycle scout team provides speed and flexibility without requiring the platoon leader to dedicate a full vehicle crew. During complex unit movement, the scout may function as a traffic control point. In this scenario, the scout uses the motorcycle to move from location to location without having to coordinate pickup after the traffic control point is no longer needed.

A fourth use for the motorcycle scout is to provide liaison between adjacent units. Motorcycle scout teams can rapidly deploy to contact points and establish face-to-face communication to coordinate linkups, passage of lines, and other operations requiring secure, in-depth coordination.

Along similar lines, motorcycle scouts can restore communications in situations in which enemy tactical operations, NBC, or intense conventional fire strikes have created gaps between adjacent units. In this scenario, the scout may have the mission to locate friendly units that may have suffered damage. If radio communications have been damaged, the motorcycle scout may also act as a messenger.

The motorcycle scout may be used in other functions too, such as quartermaster activities. Indeed, the platoon leader's use of the military motorcycle is limited only by his tactical creativity.

The military motorcycle has proved its usefulness throughout military history, even during Desert Storm. The Army must continue to work toward

making it a permanent part of the Army inventory. The military motorcycle provides combat leaders with an effective, flexible vehicle to maneuver on the battlefields of today and tomorrow.

### References

Bacon, Roy, *Military Motorcycles of World War II*, London: Osprey Publishing Ltd., 1985.

Caidin, Martin and Jay Barbree. *Bicycles in War*. New York: Hawthorn Books, Inc., 1974.

FKSM 17-19-3, *Military Motorcycle (MILMO) Supplemental Text, MOS 19D, Skill Levels 1-4*. Fort Knox, Ky: U.S. Army Armor School, April 1991.

*Tactical Employment of the Military Motorcycle (training videotape)*. PAN #A0515-91-0189, Fort Knox, Ky: U.S. Army Armor School, 1991.



## City of Radcliff Dedicates Tribute to Armor Soldiers

The City of Radcliff, Ky. has dedicated a new monument commemorating the soldiers of the Armor Force who have trained at nearby Fort Knox since 1932. The 12-foot, bi-triangular structure, formed of gold-anodized aluminum, was designed by LTC (Ret.) Burton S. Boudinot, a Radcliff resident and former Editor-in-Chief of *ARMOR*. The structure is mounted on a black granite base in a lighted, landscaped area outside Radcliff City Hall. Originally conceived in 1985, the idea languished for lack of funds until new interest arose during Operation DESERT STORM. Funds came from private citizens, businesses, and local civic clubs.

Richard B. Armstrong is a doctoral candidate in Instructional Systems Technology at Indiana University. He works at the Armor School as chief, Analysis Branch, Training Division, Directorate of Training Development. He is currently developing a theory for prescribing instructional strategies for teams.

Lieutenant Colonel Craig S. Harju Sr. has previously served as cavalry platoon leader and assistant S2, 2-17 Cav; tank platoon leader, XO, S2, and combat support company commander, 1-32 Armor; assistant professor of military science at Upper Iowa University; deputy ACoS G2, AFCENT Reserve Corps (Fwd) in Maastricht, Netherlands; assistant G3 plans, 3AD; S3, 2-32 Armor; and chief, Training Division, DOTD, and later Director of Training Development at the Armor School. He is currently the chief, War Plans Section of Headquarters, Allied Land Forces Southeast Europe in Izmir, Turkey.

Sergeant First Class David F. Wilson has previously served as platoon sergeant with 2-69 Armor, 3-4 Cav, and 1-10 Cav. He taught scout platoon tactics while assigned to the Command and Staff Department, USAARMS. He currently works as a 19D task analyst in the Analysis Branch, Training Division, Directorate of Training Development.

# Remembering

## *Two Officers, Two Outcomes The Difference Was People*

by Major Dale E. Wilson and Command Sergeant Major Robert A. Murphy

The banner stretching across the back wall of the Newburgh Holiday Inn's banquet room welcomed the graduates of the U. S. Military Academy's Class of 1991 to their twenty-fifth reunion. The room was virtually empty now, except for the two gentlemen who'd just sat down at the bar in front of me. One was dressed in a sportcoat and tie, the other wore Class A with the two stars of a major general pinned to the epaulets on his shoulders.

"Bartender, how about a couple of Seven-Sevens for my friend and me," the general said.

I busied myself mixing the drinks while they began talking over old times. From what I could hear, they'd been roommates during their last year at the Academy, and they'd both gone Armor. That was the last time they'd seen each other before tonight. I set the drinks on the bar and glanced at the general's name tag. Jameson. Damn, he sure looked familiar. Then it dawned on me: he'd been a platoon leader and later company XO in A Company, 2-77 Armor at Ft. Carson back in the early '90s when I was the first shirt.

"Hey, sir," I said, "remember me? I was first sergeant of Alpha 2-77 when you were an LT."

"Well, I'll be a son of a gun!" he said, as the recognition spread over his face. "'Top' Smythe! Boy, those were the days, weren't they?"

"Yeah," I said with a laugh. "What a great outfit we had."

He gestured to the man in civilian clothes seated beside him. "Meet Don Bassett. He was my roommate at the Academy the year we graduated. He's an ex-tanker. Spent time with the 5th Mech at Polk and Hood before he got

out in '94. Don, this is 'Top' Bill Smythe. He broke me in back at Carson during my first tour there."

We shook hands. Bassett looked much older than Jameson. The years had been less kind to him. Who says Army life is so much harder on the body? "It's a pleasure, sir," I said. "I'm sure you gentlemen have a lot of catching up to do and I've got to get ready to close, so, if you'll excuse me . . ."

"Sure, 'Top,' good to see you again," said Maj. Gen. Jameson. He turned back to Bassett and they began an animated conversation.

As I tidied up behind the bar, I couldn't help overhearing them. They started out with the usual stuff: family situation, bringing each other up to date with what they'd been doing over the years, etc.

The general, it was clear, had followed the fast track. Beginning with promotion to major he'd been a below-the-zoner all the way. He'd just finished a tour as assistant division commander for ops and training with the 1st Armored Division at Ft. Hood — where the colors had been brought from Germany back in '95 — and was on his way to Ft. Stewart to take over the 24th Mech.

Bassett, on the other hand, had had a tough go. He'd been passed over for promotion to captain and got his pink slip in late '94. After that he'd gone back to grad school, got an MBA, and went to work for a Fortune 500 company in New York — where he'd been ever since.

It was typical reunion talk — until they started comparing notes on their tours as platoon leaders. What made their discussion of that experience so fascinating was that it sounded like a

complete lesson in training young officers.

"So what happened to you back at Polk, Don?" the general asked. "I know it's a touchy subject, but I remember what a fire-breather you were as a cadet and how hard-charging you were in AOB. I just can't imagine you not cutting it as a platoon leader and then getting passed over for captain."

Bassett chuckled. "Yeah, neither could I. I remember everything they told us about hitting the ground running, but it's hard to run in mud."

"What do you mean?"

"Well, for starters, I never really got any help," said Bassett. "My company commander was one of those guys who wanted everything to be perfect. He never had any time for us lieutenants, nor would he tolerate any mistakes. If any of us made the least little screw up, he'd start getting into our business."

"Nor did he ever meet with us or ask us what we thought. Rather than take the time to explain what he wanted or how he thought things should be done, or listen to any ideas we might have, he just did things himself. I felt as useless as the third leg on a duck."

The bitterness in his voice was plainly evident.

"The SOB spent all his spare time up at battalion sucking up to the CO, and if anything went wrong it was always somebody else's fault. The old man never questioned him because he always had paperwork to cover his posterior."

The general nodded. "What about your platoon sergeant? Wasn't he any help?"

Bassett shook his head. "Naw. He was one of those pretty boys who thought he was superior to officers."

---

Remember how they always told us that the relationship between a lieutenant and his platoon sergeant should be like a good marriage? Well, we were estranged from the get go. I got the feeling he had no desire to work with me — or any platoon leader. I remember dropping by the snack bar for lunch after my first ARTEP. He and several other platoon sergeants from the battalion were sitting at a table near the serving line. He had his back to me, so I know he didn't see me. I heard him discussing my map reading skills with them.

"My LT couldn't find his backside with both hands," he said, and the others laughed. "Those guys they keep sending us from Knox are worthless. I don't know why they bother. We NCOs could do a damned sight better job than they do."

"The other NCOs muttered in agreement. That's all I heard. The line had carried me out of earshot. But it was so typical of our relationship. It always seemed like he wanted me to fail," Bassett concluded.

The general shook his head and rubbed at the bridge of his nose, thinking for a moment before responding.

"You know, Don," he said, "I've seen similar situations over the years. Sadly, we lose a lot of good officers that way. I'm just glad it didn't happen to me. It sure wasn't like that in old Alpha 2-77, was it, 'Top'?"

I looked up from the glass I'd been polishing with a bar towel for the last several minutes while eavesdropping on their conversation.

"It sure wasn't, sir," I said. "If I'd ever caught any of my NCOs playing silly games like that I'd have ridden 'em out on a rail. And the old man was a real gem, too, remember? He really knew how to train lieutenants."

"That's right," the general agreed. "I remember how, when I first reported in, he was in the middle of a nasty Article 32 investigation. But he dropped everything and made me feel like I was the most important person in the world at the moment. He spent

more than an hour and a half talking about the company and the battalion, their lineage and honors, what they'd been doing for the previous six months, what we'd be doing for the next six months, the six people I'd be working with, where he expected me to fit in, and what his expectations of me were.

"Then he turned me over to you, 'Top.' You filled me in on the strengths and weaknesses of all the men in my platoon, including my platoon sergeant. You had nothing but praise for him and I came to find out he felt the same way about you. Both you and the old man stressed the importance of my attitude toward SFC Allenby and the other NCOs in the platoon. You said I should never forget who was in charge, but that I should always be open to suggestions from them, to recognize that I was new to the job and that they had years of experience that would benefit me greatly if I'd just listen to them. You were so right. Best of all, you'd made them understand my limitations as a brand-new platoon leader and made them aware that you held them accountable for my success."

The general looked at his old roommate and put a hand on his shoulder.

"Rather than make jokes about my problems, my platoon sergeant pulled me off to the side and either taught me how to do things properly, or politely and patiently explained what I'd done wrong and suggested ways I might have performed better.

"Although the old man'd made it clear that I was always responsible for everything that went on in the platoon and had the final say so, SFC Allenby explained that in garrison I should let him physically run the show — especially when it came to individual soldier training. But, as soon as we rolled out the back gate and headed down range, that platoon was mine. He stepped to the side and let me run with it. He was always there with advice and ideas when I needed them, but he never got pushy about it. What a great NCO!"

"Yeah," I said, "Allenby was a super soldier. You know, sir, he went on to become a command sergeant major and retired in '09 with thirty years after a tour as CSM of the 1st Cav."

"What about you, 'Top'? When'd you hang up your spurs?" the general asked.

I checked out of the net in '04 and came here. I never accepted a CSM job above battalion. Anything higher is too damn far away from troops for my taste."

"I know what you mean," he chuckled. "I'd have been happy if they'd just let me stay with battalions. But," he glanced at his shoulder and shook his head, "you know how it goes."

"You know," I said, "we had good NCOs back in Alpha Company, but it wouldn't have been that way if it hadn't been for Captain Morton. He really knew his stuff. When he came on board we had a bunch of primadonnas, but he changed that in a hurry."

I looked at Bassett. "You see, sir, we had a CO before Morton who was just like the one you described. He constantly bypassed the lieutenants, so the NCOs knew they were the key to his success or failure and got a real attitude. There wasn't much I could do about it. But Morton. Whew!"

"When he first showed up he called all of us together and said the free ride was over. From then on he was going to take the lieutenants under his wing and train them. He charged me with squaring away the enlisted side of the house and told the rest of the NCOs that he and his officers would stay out of sergeants' business, but that they'd better be straight or he'd be all over them like white on rice. They got the message in a hurry after he sent a couple of tank commanders and platoon sergeants packing — with adverse NCOERs and bars to reenlistment as their reward."

"That was before I got there," the general interjected. "When I reported in, he immediately began training me. He had the XO tutor me in maintenance activities and he'd spend about



an hour a day with me discussing tactics and leadership. Every so often during command maintenance periods he'd get all of us lieutenants together and quiz us on some aspect of maintenance operations.

"He was a real stickler for leadership by example. There was no BSing around the orderly room or platoon offices during the duty day. If the training schedule called for maintenance, we were all in the motor pool — including the CO and 'Top.' The old man was always in coveralls, and you never knew where he'd turn up when he wasn't sweating over his own tank with his crew. He said the technique did three things for him: it helped him learn; it gave him a chance to observe the skill level of the soldiers, NCOs, and officers in the company; and it allowed him to demonstrate his own competence and willingness to share the troops' hardships. The same thing applied to individual and collective training. He would just pick a platoon and show up and go through the training like a private. I learned a lot from that and I've tried to do the same thing ever since, wherever I've been."

The general looked at me and grinned. "You know, 'Top,' the thing that most impressed me about old Captain Morton was how much he cared for those soldiers. I mean really cared."

He swiveled his stool to face his companion. "You should have seen this guy, Don. He kept a notebook that had vital statistics on every one of the 64 of us in the company. And he had most of it memorized. He knew every man's first name, age, hometown, parents' or spouse's names, and could tell you how he'd scored on his last SQT and APFT.

"He required us to keep the same data on the troops in our platoons and would quiz us to see how well we knew the men.

"Whenever anybody in the company got an award, a letter of commendation, or a certificate of achievement — and that happened a lot in old

Alpha Company — he'd take the time to make a copy of it and send it along with a personal note to the soldier's parents or spouse. I'm convinced those guys would have followed him into the gates of hell.

"But he was a hard one to figure out sometimes. He had a real Jekyll-and-Hyde personality. Some days he'd run around the company area with a big smile and a pat on the back for everybody. Other days he was like a fire-breathing dragon. Nothing seemed to make him happy." The general looked at me. "Come to think of it, 'Top,' you were the same way."

I chuckled. "You never figured it out, sir? We had a 'Mutt 'n Jeff' routine. Remember that round yellow coffee cup with the smiley face he kept on his desk?" The general nodded. "Well, he had a frown painted on the other side. First thing I did when I walked into the orderly room was look at that mug. Whichever face was displayed was the mood he'd portray that day and I'd act the opposite. Sure kept you folks on your toes, didn't it?"

The general laughed until his eyes began to water and his companion smiled wistfully.

I looked at the clock on the wall. It was five minutes to two. Almost time to close.

"Last call, gentlemen," I said.

The general pushed himself up. "Guess we'd better call it a night, Don. It sure was good to see you again."

"Same here, Harry," Bassett said. "See you at the game tomor — today, I mean?"

"Yeah. Let's hope Army kicks Lafayette's butt."

Bassett nodded in my direction. "You know, Harry, if I'd been in a unit like you and 'Top' Smythe were in, I can't help but think my life would've been a whole lot different."

The general put his arm around his old friend's shoulder. "I agree, Don," he said with a squeeze and a nod of his head, "it made all the difference for me."

*The authors served together as commander and first sergeant of Company D, 2-34th Armor at Ft. Carson in 1984-85. The unit was awarded the FY '85 Draper Leadership Award.*

Major Dale E. Wilson (USA, Ret.) is a former Armor officer who served as a cavalry platoon leader and tank company and tank battalion headquarters company commander. A 1979 OCS graduate, he enlisted in 1969 and served as an infantryman and combat correspondent in Vietnam with the Americal Division in 1970-71. He holds a PhD. in military history from Temple University and served as an assistant professor at the U.S. Military Academy before retiring in September 1991. He is the author of *Treat 'Em Rough! The Birth of American Armor, 1917-20* (Presidio Press, 1989).

CSM Robert A. Murphy is command sergeant major of the 2/7th Cav at Ft. Carson, Colo. A veteran of more than 20 years of service in Germany, CONUS, and Korea, he is a 1989 graduate of the Sergeant Major's Academy. He has held every Armor NCO leadership position from tank commander to CSM, including serving as first sergeant of two companies at Ft. Carson and one in Korea, as CSM of the 2-34th (later 2-77th) Armor, and as an operations sergeant major in Korea and at Forts Carson and Bliss. He holds an associate degree.

# Flying A Desk

by Captain John K. Bartolotto

So, your next assignment is the dreaded functional area utilization tour. You wonder, "who at branch did I infuriate?" You want another troop assignment, but you've done that part of your career. Now it's time to sit behind a desk and earn your pay working in your functional area. A little frustrated, you come to grips with the fact that you don't have much of a choice but to fly a desk for the next three to four years. If you are a captain, with between five and seven years of service, you've already been or will be informed what your functional area will be. There are many, and one is not better than the other, it depends on what you want to do with your career and future once you take off the green suit.

This is the side of the Army your OCS, ROTC, and West Point instructors never (really) told you about! Welcome to a world where most of the branch related things you've learned in a line unit, where the rubber meets the road, seem out of place. Even the acronyms that you've grown accustomed to in your troop assignment, like PMCS, have other meanings like: Program Management Control System, and not Preventive Maintenance Checks and Services. Now, your job will be to help design, plan, research, develop, study, resource, and support the rubber that meets the road. You're a little overwhelmed at first, and even have flashbacks of when you were a new lieutenant reporting into your first unit. It's a whole new, different world, and you've been planted right in the middle of it. Your

palms sweat, and you hope that you'll wake up from this bad dream and find yourself on a range with the sweet smell of cordite burning your nostrils and fire commands crackling over your CVC. Sorry.

A functional tour is not the end of your career that you at first believe it is. If you consider it a growing experience that will further your knowledge of how the other side of the Army operates and supports "the field Army," mixed with some great benefits, you'll learn to tolerate your time away from troops and maybe even enjoy it.

The majority of functional tour assignments will find officers sitting behind a desk doing some sort of staff work. No matter what functional area an officer is assigned to, the old military maxim, "The function of the staff is to serve the line," applies. The Training and Doctrine Command motto best sums up what all officers serving in functional assignments must remember is their sole mission: "Prepare the army for war." Does that make it easier for anyone in a functional area assignment to tackle the sometimes day-to-day challenges that occur while you're sitting behind your computer? Probably not. So, what can you do to make your assignment more meaningful to you professionally and personally, and what should you be prepared for?

Functional area assignments give you the opportunity to have an unbelievable amount of personal time. Unlike troop assignments, where you're up and running PT at 0630, functional area assignment hours usually begin at

0730, and the normal work day is completed by 1730. PT is on your own, whenever you can find the time, and you need to find the time. Your spouse will inevitably be amazed at the amount of time you can now spend at home. You should take advantage of this Army gift and plan on some outstanding family time. The opportunity to do things with your family is probably the best thing a functional assignment has to offer, and after a troop assignment, your family deserves it and so do you.

Unlike the "outdoor Army," unit activities are few and rare, so take advantage of the social activities that are offered in and around your new assignment area. Career-wise, you'll find that your functional area offers some great military courses that you should take advantage of and fight to get.

Advancing your civilian education is another option that you should explore. You'd be surprised how many funds, grants, and programs are available to further your education. A masters degree is an excellent line to have on a resume if you're contemplating leaving the service. In this day and age, having a plan of what you might do if you leave the service is just as important as having one if you plan to remain. Taking the Command and General Staff College course by correspondence is also an excellent requirement to fulfill during your tour, especially with your new found spare time at home. Whatever you choose, you'll have the additional time to do it, whether it's spending time with

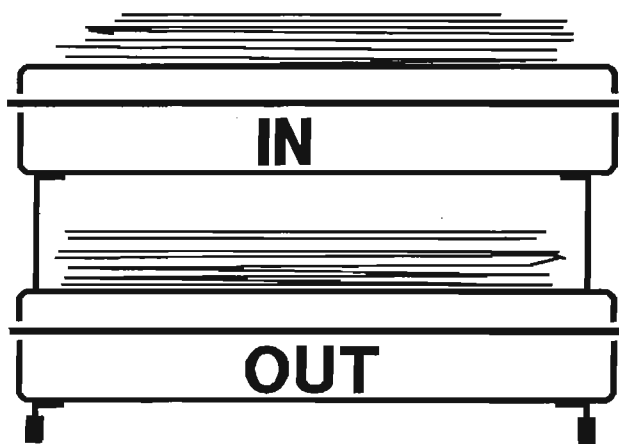

---

your family or furthering your military or civilian education. The key is to make the most of your spare time.

Working with civilians and computers will be your two most prominent and new challenges in these type of assignments. Your professional development will definitely benefit from both. The tremendous number of civilians at functional assignments are the backbone of this side of the Army. Like noncommissioned officers in line units, civilians can provide you with the vital resources of their knowledge, skill, and background that no functional area course can provide. Civilians are there to provide continuity for the organizations, which military personnel, with their usual PCS moves, cannot. Working with civilians also provides opportunities for networking. Networking is basically a way of making contacts with the leadership of civilian industry. It is cited by job placement companies as the most prominent factor in getting a job in the private sector (something to keep in mind during these days of uncertain force reductions). The sooner you learn to take advantage of this vital resource, the sooner you'll learn more about your new job and enjoy it.

Your interaction with the civilian work force will also broaden your knowledge of another side of personnel management, one that you just don't experience in a troop unit. You will quickly realize that there is a different set of standards and expectations in dealing with soldiers versus your civilian counterparts. Don't treat civilians like soldiers. Your experiences in the office will actually help your leadership style to grow, believe it or not, as you come into contact with various styles of executive leadership. Unfortunately, there are bad apples in some functional assignments, just as there are in some line units. Take the opportunity to learn what not to do from these people. Patience and flexibility are two qualities you'll need as you learn to adapt and function in a non-troop unit environment where the paperwork never

seems to move fast enough. Mastering computer word processing and graphics programs is an area that you need to get ready to dive into. Most assignments have computer courses available, and even if they just make you less dangerous on the keyboard, I suggest you take one. If you know how to "touch type" (as opposed to hunting and pecking for the correct key), you'll be ahead of the pack when it comes to working with a word processing program and getting paperwork completed.

Which brings me to the next subject: writing. Staff work at a functional assignment entails an enormous amount of paperwork; writing clearly and concisely are keys to success. Your ability to communicate with the written work will make or break you. The effective writing courses taught at OAC and CAS<sup>3</sup> will come screaming back at you, and your paperwork will be a reflection of you and on you. Concentrate on getting it correct the first time.

Security. This is an important word that you must pay attention to at functional assignments. Classified documents and computer disks abound everywhere. Take the time to ensure you always safeguard classified material. It may sound minor; but believe it or not, many an officer has had his career tarnished by leaving classified material on his unattended desk or a safe unsecured. Use the same common sense OPSEC thinking in the office as you would in a line unit. Be aware of the security SOP for your office, especially when it comes to using secure/nonsecure FAXes, telephones, and computers.

In all functional assignments there is one thing that you must take heed of: from the first day to the last day of your tour, you will be considered the expert in the area you are working. You must quickly learn to work with details. Unlike your branch assignments, in which the NCOs are the experts in one field, and the officer must

---

*Networking is basically a way of making contacts with the leadership of civilian industry. It is cited by job placement companies as the most prominent factor in getting a job in the private sector*

---

learn the overall picture, a functional assignment requires you to do just the opposite. Remember you need to become an expert, not a bureaucrat. Keep the following in mind during your functional tour: be innovative, learn to sell your projects, answer the question(s), don't dwell on past history of projects, keep an open mind, ask for help when you need it, and keep your sense of humor. After a few months, all the new acronyms, documents, and projects will be second nature and you'll be an "expert."

Your functional area assignment may not be as exciting as a branch assignment, but your career depends on your ability to successfully tackle this challenge. Your knowledge of the total Army will increase tenfold, and you might even be able to take some of the skills you learn at that assignment and apply them when you return to troops.

Captain John K. Bartolotto is a 1983 ROTC DMG of the State University of New York at Potsdam. He has served as a tank platoon leader, scout platoon leader, and tank company XO with 2-67 Armor, 3AD; S4 and tank company commander with 4-67 Armor, 3AD; S3 Air for 3d Brigade, 3AD; and assistant OPS officer G3 OPS, 3AD both in FRG and during DESERT STORM. He has attended AOB, AOAC, NBC School, Air Assault School, CAS<sup>3</sup>, the Combat Developments Course and Material Acquisition Management Course. He is currently assigned in his functional area 51 (R&D) at HQ, TRADOC, Fort Monroe.

# Bernard Law Montgomery:

by David Craig

In 1946, Field Marshal Sir Bernard Montgomery was elevated to the loftiest position in the British military, replacing his friend and mentor, Field Marshal Sir Alan Brooke, as Chief of the Imperial General Staff (CIGS). His tenure proved to be disastrous because of his abrasive personality,<sup>1</sup> and he stepped down in 1948. Without Brooke to shield him, Montgomery could not cope. Even the royal family found his megalomania difficult to tolerate.<sup>2</sup> Curiously though, it was his narcissism that kept him in the limelight during the Second World War in spite of his gross incompetence as a field commander who knew little of high mobility warfare.

Interestingly, the debacle at Dunkirk, in May 1940, propelled the career of officer Montgomery to prominence in British military circles. As commanding general of the British 3rd Infantry Division, Montgomery acquitted himself extremely well in Belgium, even though he never saw a German tank. He made the remark later that he felt a well-trained and mobile infantry division could handle the finest Panzer.<sup>3</sup> Yet it was common knowledge that German armor had won the victory. Colonel Baron Hans von Luck, who was with Erwin Rommel's 7th Panzer Division at Dunkirk, recently surmised that, had Hitler not issued his famous stop order to von Rundstedt, the entire British Expeditionary Force — including Montgomery's well-trained 3rd Infantry Division — would have been overrun and destroyed.<sup>4</sup>

## Role in the Dieppe Raid

After the devastating defeat of the BEF at Dunkirk, Montgomery was

chosen as Southeastern commander, under General Sir Bernard Paget of Home Forces. Although this is not widely known, one of his major tasks was the planning of the Dieppe Raid, first called Operation RUTTER, and later, Operation JUBILEE. In one of the first of many blunders that revealed his ignorance of modern mobile warfare, Montgomery took it

upon himself to change the plans for armored flanking attacks north and south of Dieppe, intended to isolate German forces in the city from their reinforcements, while infantry launched its simultaneous frontal assault. Instead, Montgomery eliminated the flanking attacks, changing the operation to a frontal infantry assault with supporting armor coming in be-



# A Question of Competence



hind the infantry.<sup>5</sup> JUBILEE was a total disaster. Had the raid been carried out as originally planned, with a clear understanding of the value of armor and infantry working together, it might well have succeeded. As it was, 5,000 Canadian soldiers were lost, and German propagandists had a field day.<sup>6</sup> Montgomery, however, escaped criticism because, two weeks

before the raid took place, he had been ordered to El Alamein, in North Africa.<sup>7</sup>

## Blundering In North Africa

By July 1942, the British commander in North Africa, GEN Sir Claude Auchinleck had managed to stop a year-long retreat with his bat-

tered and bruised Eighth Army at a dirty little Arab town called El Alamein. He formed a defensive line from the Mediterranean Sea to the impassable Qattara Depression and thwarted a determined Erwin Rommel from taking Cairo and the Suez Canal. After the battle had ended, and a very frustrated Afrika Korps had fallen back to regroup and await supplies

## Disaster at Dieppe: 5,000 Allied Troops Lost



British Churchill tanks lie destroyed and abandoned on the rocky beach at Dieppe after the Germans soundly trounced the invading Allied troops. The Churchills were being employed in their first combat operation. The author contends that Montgomery misused his armor as supporting artillery for the invading Canadian infantry.



and fresh troops, the "Auk" started reforming his army to go on the attack. He abandoned the traditional format of infantry forward with armor in support to one of armor and "lorried infantry" attacking together in tandem. Essentially, Auchinleck was borrow-

ing a page from his opponent, Rommel, who had employed the same techniques with his highly successful panzers.<sup>8</sup> But before he could finish making the changeover, he was ignominiously sacked by Winston Churchill, who was pressed for a military

victory to keep him in political office. Montgomery was given command of the British Eighth Army.<sup>9</sup>

Montgomery, a traditional staff officer from the First World War, was an advocate of the set-piece battle and attrition warfare. He believed, as did his mentor Alan Brooke, that armor was to be used only as mobile support artillery for the infantry.<sup>10</sup> He was appalled when confronted with Auchinleck's new configuration and quickly assumed that Auchinleck was setting his army up for a mad dash to the banks of the Nile and a new defensive stand. Montgomery notified a very frustrated Churchill that it would take him two months to train the totally "demoralized" army and mold it into a cohesive force, one capable of grappling with "a very tricky" Rommel.<sup>11</sup>

In the combat that followed, 13,500 British troops fell victim to Montgomery's WWI-style set-piece battle of attrition at El Alamein. Rarely in the history of warfare was military incompetence more evident than in the North African desert in October 1942 through May 1943. Men were slaughtered needlessly advancing through minefields in the face of murderous

## North Africa: Victory at a High Cost



Despite his victory in the desert, Montgomery learned little of tank tactics and less about mobile warfare. Here, PzKw IIIs of Rommel's Afrika Korps race to reposition themselves in Libya.

machine gun crossfire. Armor advanced only reluctantly, and completely unimaginatively, after the infantry had cleared the minefields. Six hundred of the 1,200 British tanks were quickly destroyed or immobilized by Rommel's 200 war-torn and scarred tanks. Finally, after 11 days of brutal punishment, Rommel, with 30 tanks left and dangerously low on fuel, started a slow retreat westward across the North African desert. The Afrika Korps, virtually eliminated as a viable force, still continued to outmaneuver Montgomery and evade his entirely predictable, bludgeoning advance. Finally Rommel, after six months of highly skillful evasive action, escaped to fight another day,<sup>12</sup> while praise was heaped on Monty for having soundly trounced the Desert Fox.

The tank had played only a supportive, inefficient, and unimaginative role under Montgomery. He knew nothing of tank tactics and would not permit his subalterns to express innovative ideas, even though Rommel, with much inferior forces, was dancing elusively before him.

### The Sicilian Campaign: Comparison with a Master

Montgomery's performance in Sicily, as well as in Italy, was equally uninspiring. The Allied invasion of Sicily in July 1943, while not epitomizing the alliance's finest hour, did offer an example of the proper use of armor, which was under the command of the master tanker, George Patton. Shunning Montgomery's traditional approach, which had served the British so well during the Boer Wars, Patton pressed his armor into action shortly after landing at Licata and Gela on Sicily's southern coastline.

He raced north for Palermo, then east to Messina, arriving the day before Montgomery's troops entered the city from the south. Montgomery sustained 11,843 casualties in the 38-day campaign, while Patton lost 8,731.<sup>13</sup>

## Sicily: Another Plodding Performance



British soldiers unload ammunition and vehicles on the first day of the invasion of Sicily, July 10, 1943.

Patton, however, had covered a distance three-and-a-half times that of Montgomery with greater exposure to enemy opposition.

Montgomery was relieved of his command of the British Eighth Army in Italy, although his slow and unimaginative performance earned him the reputation in Great Britain for being prudent with the lives of his troops. He returned to England to relieve Lieutenant General Frederick Morgan (COSSAC) from his 1943 preliminary planning for the assault on Normandy.

The decision to appoint Montgomery as ground commander for the cross-channel invasion was a political one. Harold Alexander was better qualified because he was Army Group commander in Italy, but Churchill really had no choice. He would have been keelhaunched by the British people had he chosen otherwise, because Monty was considered the messiah, the savior of the British Empire since El Alamein, and he could do no wrong.<sup>14</sup> Montgomery did not attempt to persuade them to the contrary.

### Overcautious At Caen

The key to the success of the Normandy invasion was the early capture of the city of Caen, nine miles inland from the seaside resort town of Riva-Bella, at the confluence of the Orne River and the sea. Caen, Normandy's major road and rail center, was vital to Allied strategy and had to be taken on the first day. Beyond Caen, the plains of Falaise to the southeast of the city were important also. The flat land was suitable for airfields and ideal for tanks. Failure to take Caen the first day would dangerously compromise the invasion.<sup>15</sup>

ULTRA code-breakers determined that Rommel had positioned the refitted 21st Panzer Division (which had been destroyed in North Africa and had been reconstituted of mostly inexperienced troops)<sup>16</sup> southeast of the city. It was the only obstacle facing Montgomery's forces, other than light beach defenses. The British, however, faced one major obstacle that came close to destroying them and over

which they had no control — the weather.

A storm of considerable severity struck the English Channel on June 4, 1944. Eisenhower summoned his meteorologist, who advised him that the storm would abate long enough to allow the invasion to proceed before the storm closed in again. Eisenhower issued the command that set NEPTUNE in motion. Miraculously, the weather lifted, and the invasion armada was set irrevocably under way.<sup>17</sup> The tides from the storm surge, however, were very high. Bradley and the American forces decided to launch their assault on Omaha and Utah beaches at 0630 hours, while Montgomery and the Canadian and British forces opted for 0730 hours to achieve a higher tide with less beach to cross before reaching the dunes. The higher tides had some effect on the American divisions, but Sword Beach was a disaster. Where the beach at Riva-Bella is normally 30 yards wide at high tide, this day the beach was a scant 30 feet,<sup>18</sup> hardly enough room to accommodate a Sherman tank!

A traffic jam of horrendous proportions developed, with tanks stalled in long lines of supply vehicles.<sup>19</sup> No priority had been given to armor even though, according to Montgomery, three armored brigades were committed to take Caen before the 21st Panzer Division could counter.<sup>20</sup> As it was, without any supporting armor, the British 3rd Infantry advanced cautiously to within three miles of Caen before encountering elements of the 21st Panzer Division at 1400 hours. Fortunately for the British and Canadians, confusion and uncertainty in the German high command had delayed the 21st Panzer Division from counterattacking until 1400 hours, and the 12th SS Panzer Division stationed nearby was not released until 1500 hours!<sup>21</sup> The 3rd Infantry was stopped in its tracks, and the prize of the city



*"Questions quickly arose in SHAEF headquarters regarding Montgomery's competence. Eisenhower was angered and dismayed with Monty's performance, and recrimination raged"...*

of Caen would remain elusive for the British until late July, when Omar Bradley's Operation COBRA and George Patton's Third Army were loosed from the strangling hedgerows of Normandy.

Armor was absolutely essential for the capture of Caen and the open plains to Falaise. Yet Montgomery and his commanders treated armor like a stepchild. Confronted with narrow beaches and abnormally high tides, with beach defenses all but eliminated by the commandos earlier, a skilled tank commander would never have put up with a traffic jam. Without question, he would have pushed his armor over the embankments and into the village streets.<sup>22</sup> But Montgomery's tank commanders were not permitted any freedom to act on their own. The potential for disaster was there, with 21st Panzer in the shadows, and 12th SS Panzer not far away. Warehousing tanks on the beach came very close to spelling disaster for the entire invasion, and perhaps the outcome of the war.

### The GOODWOOD Fiasco

On July 18th, Montgomery launched a massed tank assault against fixed enemy positions in a herculean effort to finally take the ravaged city of Caen. With 3rd Infantry holding flank positions, Montgomery forged his armor east from Benouville and the

Orne River and south to Cagny in the general direction of Falaise. Before the assault, 7,000 tons of bombs were dropped on German emplacements, cratering the area and creating a moonscape surface, not unlike the battlefields of the First World War. This hampered the progress of his tanks. Colonel Baron Hans von Luck, Prussian regimental tank commander of the 21st Panzer Division, veteran of the Polish, Dunkirk, Russian, and North African

campaigns,<sup>23</sup> now faced elements of Montgomery's unsupported armor with four 88-mm antiaircraft guns. He persuaded a recalcitrant AA crew to use their guns to pick off the advancing tanks, one by one, at close range. Within minutes, von Luck, with his four 88-mm guns, had knocked out 16 Shermans.<sup>24</sup> Von Luck saw no infantry advancing with the armor and was not concerned with small arms fire taking out his gunners.<sup>25</sup> This action, Operation GOODWOOD, was a disaster, with the Germans still holding the high ground at Bourgebus Ridge, as the British suffered 5,537 casualties and lost 400 tanks, 36 percent of their armored strength in France.<sup>26</sup>

Questions quickly arose in SHAEF headquarters regarding Montgomery's competence. Eisenhower was angered and dismayed with Monty's performance, and recrimination raged uncontrolled among both his British and American staff members to send Monty packing. But Ike made the political decision to keep him, a decision most military men found difficult to swallow.<sup>27</sup>

### A Bridge Too Far — What Could Go Wrong, Did

In spite of his incompetence, Monty remained in command of 21st Army Group. Sequestered alone in his captured van, he contrived the plan for Operation MARKET-GARDEN.



Three airborne divisions would be dropped to secure five bridges along a single road, 64 miles long, from De Groote to Arnhem.<sup>28</sup> The three divisions would be relieved by a double column of tanks (Guards Armored Division) forging northward to arrive at Arnhem in no more than two days.<sup>29</sup>

Murphy's Law prevailed. The tanks had no room to maneuver. The terrain on each side of the road was marshy and unfit for tanks.<sup>30</sup> As a consequence, the Germans picked off the advancing armor like ducks in a shooting gallery, causing delay after delay. The tanks arrived at Arnhem seven days too late.<sup>31</sup> The plan amply illustrated a complete absence of understanding of the use of armor even in its most rudimentary aspects. The casualties reflected how appallingly bad the plan was; more than 17,000 in the nine days of Operation MARKET-GARDEN.<sup>32</sup>

### Was Montgomery the Victim of Ossified Doctrine?

Traditionalism, drummed into the intellectually limited<sup>33</sup> Montgomery as early as the Royal Military Academy at Sandhurst and the Staff College at Camberley, proliferated and was exacerbated by the British military establishment. Montgomery's training did not include tank tactics or strategy, other than peripherally, because the British Army traditionalists did not consider it acceptable. Tanks were to be used only reluctantly as close support mobile artillery for advancing infantry.<sup>34</sup>

Montgomery was permitted only a passing acquaintance with armor and had no training whatsoever in high mobility warfare. While his credentials were considerable as an infantry commander, he knew nothing of armored warfare. The cost in human life and treasure for his incompetency is beyond estimate and will never be known.

### Notes

<sup>1</sup>Hamilton, Nigel, *Monty: The Final Years Of The Field-Marshal, 1944-1976*, (New York, 1986), p. 727.

<sup>2</sup>*Ibid.*, p. 693.

<sup>3</sup>Hamilton, Nigel, *Monty: The Making of a General*, (New York, 1981), pp. 353-354.

<sup>4</sup>Interview with Colonel Baron Hans von Luck, July 18, 1987.

<sup>5</sup>Robertson, Terence, *Dieppe: The Shame and the Glory*, (London, 1963), p. 79.

<sup>6</sup>*Ibid.*, pp. 461-469.

<sup>7</sup>Villa, Brian Loring, *Unauthorized Action, Mountbatten and the Dieppe Raid*, (Ontario, 1989), pp. 264-267. Villa is convinced that Mountbatten acted on his own to activate the Dieppe raid, that he had neither the approval of Brooke or Churchill. The king ultimately insulated his cousin from his earned criticism.

<sup>8</sup>Barnett, Correlli, *The Desert Generals*, (New York, 1961), p. 218.

<sup>9</sup>*Ibid.*, pp. 223-226.

<sup>10</sup>Some historians believe this was the most serious mistake that Churchill committed. Auchinleck was a highly respected soldier with a track record in the desert, while Montgomery knew nothing of desert warfare. The 'Auk' had just stopped Rommel and his Afrika Korps and won the first battle of El Alamein only to be relieved because he lacked the charisma and flash Churchill needed to flaunt a military victory.

<sup>11</sup>Montgomery did not like Auchinleck, was critical of him, and gave him no credit for anything. For that matter, Monty did not get along with any of his peers. His subalterns, however, considered him messianic and bought his narcissistic behavior as reflecting genius.

<sup>12</sup>Ellis, John, *Brute Force, Allied Strategy and Tactics in the Second World War*, (New York, 1990), pp. 256-288.

<sup>13</sup>D'Este, Carlo, *World War II in the Mediterranean, 1942-1945*, (Chapel Hill, North Carolina, 1990), p. 77.

<sup>14</sup>Barnett, pp. 235-250.

<sup>15</sup>D'Este, Carlo, *Decision in Normandy*, (New York, 1983), p. 63n.

<sup>16</sup>Downing, David, *The Devil's Virtuosos: German Generals at War, 1940-45*, (New York, 1977), p. 177.

<sup>17</sup>Ambrose, Stephen E., *Eisenhower: Soldier and President*, (New York, 1990), pp. 137-139.

<sup>18</sup>Hastings, Max, *Overtlord: D-Day and the Battle for Normandy*, (New York, 1984), p. 113. D'Este, *Decision in Normandy*, p. 129.

<sup>19</sup>D'Este, *Decision in Normandy*, pp. 129-130.

<sup>20</sup>*Ibid.*, p. 146.

<sup>21</sup>Downing, pp. 177-180.

<sup>22</sup>Botting, Douglas, *The Second Front*, (Alexandria, Va., 1978), p. 57. The scale model of Sword Beach indicates several points where

exits could have been readily made. The sea-wall could have been blown by the commandos to permit passage of tanks, and more than likely with less hazard because of the absence of land mines.

<sup>23</sup>Von Luck, Hans, *Panzer Commander*, (New York, 1990). It is most rewarding to find a man still alive (age 77) who had participated in so many campaigns in the Mediterranean and European theatres.

<sup>24</sup>Hastings, p. 234.

<sup>25</sup>Interview with Colonel Baron von Luck, July 18, 1987.

<sup>26</sup>Hastings, p. 236.

<sup>27</sup>Ambrose, Stephen E., *Eisenhower: Soldier, General of the Army, President-Elect, 1890-1952*, (New York, 1983), p. 320.

<sup>28</sup>Ryan, Cornelius, *A Bridge Too Far*, (New York, 1974), p. 10. There are several fine accounts relating the events of the nine days of MARKET-GARDEN. In my opinion, Ryan's is the most thorough.

<sup>29</sup>*Ibid.*, p. 166.

<sup>30</sup>*Ibid.*, p. 30.

<sup>31</sup>*Ibid.*, p. 564.

<sup>32</sup>*Ibid.*, p. 599.

<sup>33</sup>Hamilton, Nigel, *Master of the Battlefield, Monty's War Years 1942-1944*, (New York, 1983), p. 137.

<sup>34</sup>Fraser, David, *Alan Brooke*, (New York, 1982), pp. 112-121.

David Craig left college to enlist in the Army in December 1942, began active service in February 1943, and served as a combat infantryman in France until wounded in September 1944. He was awarded a Bronze Star and a Purple Heart for meritorious conduct in combat and was medically discharged in May 1945. He received a BS degree from Butler University in Indianapolis in 1947. After retiring from a career in real estate, he earned a Master's degree in history from the University of New Orleans in May 1989. He now teaches history on occasion at Tulane University as well as other schools and writes for military periodicals.

# The Battle of Arras: Fifty-Year-Old Lessons For Today

by Captain Charles H. Benson III

## Introduction

*"When I want to understand what is happening today or try to decide what will happen tomorrow, I look back."*

—Oliver Wendell Holmes Jr.

The Battle of Arras, France, which occurred during the opening days of World War II, was a brief but historically significant battle. It is replete with lessons in the massing and synchronization of combat power, especially with regard to the employment of mixed formations of armor and infantry. Many of the problems that faced the British during this battle are problems with which we are wrestling today; the compatibility of communications systems, the employment of heavy and light forces, and the acquisition and dissemination of tactical intelligence are examples. This article will review the Battle of Arras and examine some of the problems that the British faced and their relevance to us today.

On 13 May 1940, the leading elements of the German Third Army Group crossed the Meuse River and emerged from the Ardennes Forest into the countryside of eastern France. Catching the French defenders completely off guard, the Germans quickly drove through the center of the Allied First Army Group and began their dash to the Atlantic. The combination of speed and surprise that was gained by attacking with no fewer than three armored corps through the Ardennes completely devastated the Allied command structure, sending panic and despair through the ranks. The Blitzkrieg was once again succeeding more quickly than even

the planners in Berlin had imagined possible.

As the German offensive developed, it became evident to the commanders of the British Expeditionary Force that their army was in imminent danger of being cut off from the main body of the Allied First Army Group, and their main lines of communication and supply. The bulk of the B.E.F. had come to reinforce the northern flank of the Allied defense and was at this time deployed in Belgium. The British commander's worst fears became a reality on 21 May, when the spearhead of the German Second Army reached the coast south of Boulogne. In just seven days, the German Army had driven about 150 miles, cutting the Allied armies in half and denying the British and French any opportunity to seize the initiative or mount an effective defense. The speed of the attack caught the defenders so off-balance that General von Kleist noted "my first encounter with the British was when my tanks came upon, and overran, an infantry battalion equipped with dummy cartridges for field exercises...this was a sidelight on the apparent unexpectedness of our arrival."<sup>1</sup>

The commander of the British Expeditionary Forces on the continent, General Lord Gort, came under increasing pressure from his superiors in London to assume the offensive and break his army out of encirclement.<sup>2</sup> To accomplish this he quickly conceived a plan which called for the commitment of two of his divisions to the vicinity of the village of Arras and the Scarpe River. Here they were to establish a defensive line from which Lord Gort hoped to launch an attack southward toward the village of Cambrai, and break through the flank

of the German advance to the French lines. Two infantry brigades, the 150th and 13th, under the command of Major General R.L. Petre, received this mission.<sup>3</sup> This plan met with some success initially, and on 20 May, German units met strong resistance in the vicinity of Arras and were forced to bypass the village in order to continue their march northward.<sup>4</sup> Leading the German column at Arras was the 7th Panzer Division commanded by Major General Erwin Rommel. He was followed by the SS Totenkopf Division on his left flank, and the 5th Panzer Division on his right.

The job of leading the British counterattack went to Major General Sir Howard Franklyn. The force, committed to this operation by Lord Gort, originally appeared to be quite large. "Frankforce," as the unit was dubbed, was made up of two infantry divisions, the 5th and 50th, and the First Army Tank Brigade.<sup>5</sup> The original plan also called for a simultaneous attack by two French divisions from the south, but that plan was postponed. French participation was limited to a force of approximately 70 light tanks that protected the left flank of Frankforce.<sup>6</sup>

Lord Franklyn's infantry divisions had also been whittled down drastically by the time that the attack was to have commenced. Instead of two divisions, Frankforce was limited to two battalions of the Durham Light Infantry: the 6th and 8th. These units had no radios, no trucks, no supporting artillery, and only half of their authorized number of machine guns.<sup>7</sup> The Durhams had marched almost continually for the previous ten days in hot weather, and were by now badly in need of rest. Up until this

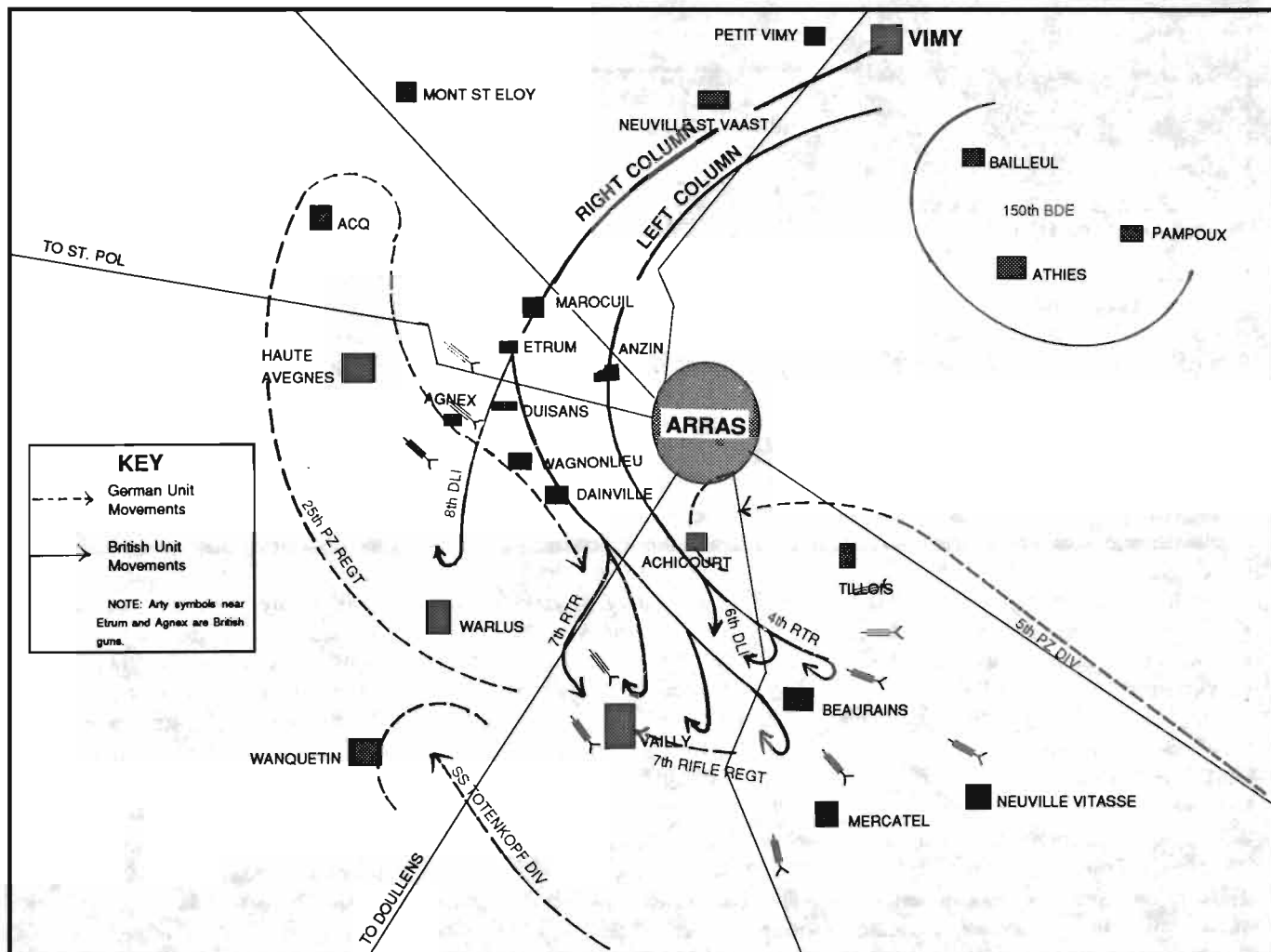

time, they had been a reserve force and had received no training in maneuver with tanks before their commitment to the battle.

The tanks of Frankforce were in equally bad shape. At this time, the First Army Tank Brigade consisted of two battalions: the 4th and 7th Royal Tank Regiments. These two units constituted the majority of the armor force the British committed to the continent thus far, and, gone hither and yon across the front in vain attempts to support the B.E.F.'s defenses. In fact, before the 20th of May, they had been in Belgium, deployed along the Dyle Line.<sup>8</sup> When ordered to rejoin the battle along the southern front, the tanks had to march approximately 100 miles to reach the British positions at Arras with no opportunity to conduct much overdue maintenance. These tanks had not been designed to operate for such intervals over such long distances. Con-

sequently, many of the original force were lost en route to worn-out tracks and other malfunctions. When they did arrive in Arras on 21 May, only 74 of the original 100 tanks were available for combat.<sup>9</sup>

The British tanks were of the Mark I Infantry and Mark II "Matilda" types. The Mark I, although heavily armored, was extremely slow, with a maximum speed of eight mph and armed with only an 8-mm machine gun. Designed as an infantry support vehicle, it was manned by a crew of two, and could withstand hits from all known antitank guns of the day. Due to its light armament, however, it was incapable of defeating an armored threat.<sup>10</sup> The Mark II tank was better armored and at least as well gunned as any of the German tanks built to date. It was manned by a crew of four and armed with a 37-mm main gun and an 8-mm coaxial machine gun.<sup>11</sup> The Matildas were to cause great con-

sternation among Rommel's troops during the battle, but unfortunately, only 16 of the 74 available tanks were Mark IIs. Furthermore, in an attempt to even the distribution of heavy tanks among the attacking force, the Matildas were divided between the two attacking columns and thus not used in mass.

Three additional factors added to the disadvantaged position the British held on 21 May. The first was a lack of a coherent and effective chain of command within Frankforce itself. Though General Franklyn had placed one of England's foremost experts in tank warfare, Major General Sir Giffard Le Q. Martel, in command of the attacking force, his two attacking columns were commanded by the infantry battalion commanders. These officers were relatively inexperienced, and traveled not with the tanks leading the attack, but with their own infantrymen, who traveled well behind



BRITISH MATILDA MK I

the tanks. Furthermore, no tank officers were present at the final orders group, so they were not entirely informed of the scope and conduct of their mission.

The second factor was the complete lack of British close air support throughout the operation. By this time in the campaign, the Luftwaffe enjoyed complete air supremacy over the continent and constantly harassed Allied troop and supply columns. The R.A.F. had been recalled to protect the skies over the homeland and was in no position to provide fighter cover for its ground force in France. The R.A.F. would not reappear in strength until the evacuation operation in Dunkirk, where it thwarted the Luftwaffe's attempt to finish the British forces off on the beaches.

Finally, and perhaps most important of all, was the failure of General Franklyn's headquarters to provide his front-line commanders with an accurate estimate of the size and disposition of enemy forces in the vicinity of Arras. General Martel was told only that "enemy infantry and tanks were known to be operating south and southwest of Arras, but in numbers not believed to be great."<sup>12</sup> In fact, General Franklyn's headquarters had received reports of strong enemy forces along the Arras-Doullens road and the Arras-St. Pol road. This placed the Germans squarely between the British and the planned start line of their attack.

### The Battle

The British left the town of Vimy, approximately five miles north of Arras and nine miles north of the start line, at 1100 hours.

The attacking force moved in two columns, which were made up of the following units:<sup>13</sup>

#### Right-Hand Column

7th Royal Tank Regiment  
8th Durham Light Infantry  
365th Battery, 92nd Field Regiment,  
Royal Artillery  
206th Battery, 52nd Anti-Tank Regiment, Royal Artillery  
One Platoon, 151st Brigade Anti-Tank Company  
'Z' Company, 4th Royal Northumberland Fusiliers  
Scout Platoon, 4th Royal Northumberland Fusiliers

#### Left-Hand Column

4th Royal Tank Regiment  
6th Durham Light Infantry  
368th Field Battery, Royal Artillery  
206th Battery, 52nd Anti-Tank Regiment, Royal Artillery  
One Platoon, 151st Brigade Anti-Tank Company  
'Y' Company, 4th Royal Northumberland Fusiliers  
Scout Platoon, 4th Royal Northumberland Fusiliers

The British faced the 7th Panzer Division and the 3rd SS Panzer Division "Totenkopf." These two units had approximately 218 tanks between them,<sup>14</sup> and a numerical superiority in men and equipment of every type over the attackers. The 7th Panzer Division was composed of the 25th Panzer Regiment, 6th and 7th Panzer Grenadier Regiments, 78th Panzer Artillery Regiment, 7th Motorcycle Battalion, 37th Panzer Reconnaissance Battalion, 42nd Anti-Tank Battalion, 58th Panzer Engineer Battalion, and the 83rd Panzer Signal Battalion.<sup>15</sup> The 3rd SS Panzer Division was composed of the 3rd SS Panzer Regiment, 5th and 6th SS Panzer Grenadier Regiments, 3rd SS Panzer Artillery Regiment, 3rd SS Panzer Reconnaissance Battalion, 3rd SS Anti-Tank Battalion, 3rd SS Panzer Engineer Battalion, 3rd SS Panzer Signal Battalion, 3rd SS Anti-Aircraft Battalion, and 3rd SS Projector Battalion.<sup>16</sup>

Shortly after the British began their march toward Arras, the tanks in the left-hand column ran ahead of their

accompanying infantry, and the two elements became temporarily separated. They regrouped, but the column commander decided that the tanks should proceed on ahead without the infantry. The tanks had not gone far when in the town of Dainville, well short of the start line, they ran into elements of the 6th Panzer Grenadier Regiment. The British sent one troop of Mark I tanks and a company of the 4th Northumberland Fusiliers to deal with this threat. Meanwhile, the remaining tanks moved on without infantry support and proceeded to wreak havoc among the main body of the 6th Panzer Grenadier Regiment's column, destroying many of its trucks and scattering its troops.

Following this initial encounter, the left-hand column continued through the town of Achicourt to Beaurains, and in the process overran the German antitank defensive screen. This was possible due to the inability of the German 37-mm antitank gun to penetrate the armor of the British tanks. The British tankers were able to destroy many of these guns while the 6th Durham Light Infantry cleared the towns and collected prisoners. When they reached the town of Beaurains, the British encountered stiff resistance from 105-mm field guns that the Germans were using in a direct fire mode. The British had finally met their match, and about 20 of their tanks were knocked out of action, bringing the left-hand column's attack to a halt. Matters worsened as the day wore on, and the column attempted to withdraw under constant harassment from artillery and dive-bomber attacks.

Part of the reason that the left-hand column had to stop in Beaurains was the trouble that the right-hand column had in keeping to its timetable and newly received reports of enemy tanks on the other side of town. The right-hand column had begun its movement on time, but encountered problems in keeping its armor to a speed that accompanying infantry could match. As a result, communications broke down almost immediately

between the infantry and armor commanders. The 7th Royal Tank Regiment became separated from the 8th Durham Light Infantry following a brief engagement with elements of the 8th Panzer Division, which had occupied the village of Duisans. Leaving the infantry behind to clear the village, the tanks raced ahead and, through some mishap, became snarled in the rear of the 4th Royal Tank Regiment's column in Dainville.<sup>17</sup>

This diversion from their intended route to Vailly caused them to narrowly miss coming into direct contact with 150 PzKpw III and PzKpw IV tanks of the 25th Panzer Regiment. The 25th Panzer Regiment unknowingly bypassed the entire British force and reached the village of Acq to the northwest of Arras without being challenged. Later, General Rommel ordered the regiment to turn around and attack the British from the north while they were attempting to withdraw.

The 7th Royal Tank Regiment eventually got back on course to Vailly, but only after losing its commander and adjutant to enemy fire. The attack was by now completely uncoordinated, and though it continued to wreak destruction and panic among the German troops, including elements of the SS Totenkopf Division, it eventually ran aground outside the village of Vailly after receiving direct fire from the Germans' 88-mm anti-aircraft guns.

The 88-mm guns were employed as antiarmor weapons in a desperate attempt to compensate for the failure of the German antitank guns to penetrate the armor of the British tanks.

These guns were under the direct command of Major General Rommel himself. He had returned to the area in search of the 7th Panzer Grenadier Regiment, which was supposed to be supporting the 25th Panzer Regiment. Rommel had been riding with the leading vehicles of the armored column when he noticed that his infantry had fallen too far behind. He and his staff officer, Lieutenant Most, re-

turned to Vailly to see if they could speed the infantry on their way. When Rommel arrived, he found his troops in a state of panic, having just been attacked by the 7th Royal Tank Regiment through their right flank. Rommel and Lieutenant Most attempted to restore order to the situation by encouraging the infantrymen to stand fast and bring fires to bear on the tanks. Eventually they came upon a battery each of anti-aircraft guns and howitzers which Rommel ordered to open rapid fire on the advancing tanks. Personally giving each of the guns its target, Rommel succeeded in knocking out the lead tank in the column and halted the British attack.<sup>18</sup> He was then able to restore his lines, bring order to his troops, and regain the upper hand on the battlefield. Rommel's losses included his aide, Lieutenant Most, who was killed at his side during their engagement with the tanks.

Though the Germans were able to regain the initiative quickly and force the British to abandon their attack short of their planned start line, the battle was to have far-reaching consequences. The German commanders had been expecting the British and French to attack their extended lines of supply and weak flanks for some time. The attack at Arras was perceived to be the forerunner of such an attack, which caused the German commanders to slow their advance, allowing more time for their units to mass forces and assume more deliberate and conservative tactics.

During the Nuremberg Trials, General von Rundstedt noted that this attack was more successful than any other Allied counterstroke of the campaign in France.<sup>19</sup> Indeed, the attack panicked Rommel himself, who exaggerated the size of the British force in his communication with headquarters on 21 May, stating that he had been "attacked by hundreds of enemy tanks," and "situation maps marked up in his own hand display arrows purporting a counteroffensive by five enemy divisions."<sup>20</sup>

When the attack ended early that evening, the losses incurred by the British attack cost the advancing German Army 7 officers, 17 NCOs, and 65 men killed; 116 men of all ranks wounded, and 173 missing. Thirty tanks were destroyed, along with numerous trucks and artillery pieces.<sup>21</sup> Approximately 20 of those tanks belonged to the 25th Panzer Regiment. These tanks were lost when the regiment attacked the British from the village of Acq, in the north, while the British were withdrawing following their encounter with Rommel's artillery.

The Germans ran into a screen of British antitank guns that the 7th Royal Tank Regiment had deployed around Duisans to cover its withdrawal. Unlike their British counterparts, the German tanks lacked sufficient armor protection from their enemy's antitank gunfire and were easy prey for the British gun crews. The result of this action was that "upwards of 20 tanks were knocked out and left burning on the ground."<sup>22</sup> Though the British attack was short-lived and too little, too late, its significance was inflated in the German commander's minds because it cost the German Army losses that were four times greater than the total suffered during their breakthrough into France.<sup>23</sup>

## Conclusions

The British counterattack at Arras provides us with numerous lessons in the conduct of armored warfare. The first is the need for communication between tanks and their supporting, or supported infantry. This lesson is especially germane to the planning of operations involving a heavy-light mix of forces. If radio communication is not possible, then some sort of mutually recognizable signals should be used to communicate during battle. Not only did the British infantry lack radios in this case, but few of the tanks' radios were working by the time the battle began.

Second is the lesson of leaders leading from a position from which they can see and influence the battle. Though it is essential that a commander position himself so that he can quickly maneuver his forces to exploit opportunities that arise, none of the British commanders did so. In fact, they positioned themselves with the infantry, which followed the tanks, rather than with the armored spearhead of their attack. They were unable to assess accurately the situation to their front, and could not coordinate their infantry units to take advantage of the gains made by their tanks, and assist in the silencing of the German antitank weapons. Because he was in the vanguard of his division, Rommel was in a position to assess quickly and influence the tactical situation. He was able to prevent a disaster in his area of operation and quickly turn the British attack into a rout.

Third is the criticality of accurate and timely intelligence to the front line commander. Had General Martel been aware of the enemy situation to his front, he would probably have adopted another, more conservative, course of action. The timetable for the entire operation was thrown out of kilter by this lack of intelligence when the British discovered enemy units on their side of the start line that "had to be mopped up to clear the way for the advance."<sup>24</sup>

Fourth is the importance of committing tanks in mass. While the British had enough tanks available to achieve a limited local breakthrough, they lacked the numbers necessary to sustain their advance. This was especially true in light of the numerical superiority that the Germans enjoyed in men and machines in the Arras area. General Martel, in reflecting on this battle stated that "if larger numbers of tanks had been available, supported by stronger mobile columns, a great success might have been achieved."<sup>25</sup> The British learned a valuable lesson from this action, however, as "the use of tanks in cooperation with mobile columns of all arms, attacking on a

narrow front, as we did in this case, eventually became a normally accepted method."<sup>26</sup> The superior armor protection that the British tanks possessed allowed them to dominate the battlefield initially and provoke terror among the defending German infantry, but their insufficient numbers ultimately resulted in their being forced to withdraw.

Finally, the importance of maintenance as an ingredient of success was brought painfully home to the British during this attack. The British lost one-quarter of their armored force to mechanical failure before the battle even began. As the battle developed, more tanks were lost to broken tracks and mechanical failure than to enemy fires. These vehicles were then completely lost to the British because they lacked sufficient recovery assets, and failed to provide infantry support to protect the recovery teams they did have, when they attempted to operate under fire.

Thus, the Battle of Arras speaks to those of us today who are still trying to master the lessons that were learned in blood and fire in France some fifty years ago. These lessons are as important to us now as they were then, and illustrate to us the need to reflect upon the past in our effort to develop our future.

### Notes

<sup>1</sup>B.H. Liddell Hart, *The German Generals Talk*, Quill, New York, 1979, p. 130.

<sup>2</sup>Brian Bond, *France and Belgium 1939-1940*, University of Delaware Press, Newark, 1975, p. 114.

<sup>3</sup>LTG Sir Giffard Le Q. Martel, *Our Armoured Forces*, Faber and Faber, Ltd., London, 1945, p. 62.

<sup>4</sup>H.A. Jacobsen and J. Rohwer, eds., *Decisive Battles of World War II: The German View*, G.P. Putnam's Sons, New York, 1965, p. 50.

<sup>5</sup>Major L.F. Ellis, *The War in France and Flanders 1939-1940*, Her Majesty's Stationery Office, London, 1953, p. 89.

<sup>6</sup>Brian Bond, "Arras, 21 May 1940: A Case Study in the Counter-Offensive," in Correlli Barnett, et. al., eds., *Old Battles and New Defenses: Can We Learn From Military History?*, Brassey's, London, 1986, p. 65.

<sup>7</sup>Nicholas Harmon, *Dunkirk: The Patriotic Myth*, Simon and Schuster, New York, 1980, p. 94.

<sup>8</sup>Douglas Williams, *Retreat from Dunkirk*, Brentano's, New York, 1941, p. 41.

<sup>9</sup>Nicholas Harmon, p. 93.

<sup>10</sup>B.T. White, *Tanks and Other AFVs of the Blitzkrieg Era 1939-41*, The Macmillan Company, New York, 1972, p. 114.

<sup>11</sup>*Ibid.*, p. 123.

<sup>12</sup>Brian Bond, p. 73.

<sup>13</sup>*Ibid.*, p. 67.

<sup>14</sup>Robert McQuie, "Historical Characteristics of Combat for Wargames," *Benchmarks*, July 1988, p. D-9.

<sup>15</sup>Samuel W. Mitcham, Jr., *Hitler's Legions: The German Army Order of Battle, World War II*, Stein and Day, New York, 1985, p. 356.

<sup>16</sup>*Ibid.*, p. 443.

<sup>17</sup>Brian Bond, p. 65.

<sup>18</sup>B.H. Liddell Hart, *The Rommel Papers*, Harcourt, Brace, and Company, New York, 1953, p. 31-32.

<sup>19</sup>Alistair Home, *To Lose a Battle: France 1940*, Little, Brown and Company, Boston, 1969, p. 508.

<sup>20</sup>*Ibid.*

<sup>21</sup>Brian Bond, p. 73.

<sup>22</sup>LTG Sir Giffard Le Q. Martel, p. 68.

<sup>23</sup>Alistair Home, p. 508.

<sup>24</sup>LTG Sir Giffard Le Q. Martel, p. 66.

<sup>25</sup>*Ibid.*, p. 69.

<sup>26</sup>*Ibid.*

Captain Charles H. Benson III was commissioned through OCS in 1986. He holds a Bachelors degree from the University of Alaska at Anchorage and a Masters degree in anthropology from Case Western Reserve University in Cleveland, Ohio. He served as a tank platoon leader, headquarters XO, and battalion adjutant with 3-8 Cavalry in Germany. A graduate of Armor Officer Basic, Armor Officer Advanced, and Field Artillery Officer Advanced Courses, he is currently the squadron maintenance officer for 3d Squadron, 1st Cavalry, 5th ID, Ft. Polk, La.

# Using "Push Packages" To Resupply Cavalry Operations

Replenishment by Exception Saves Time, Cuts Net Traffic

by Captain Daniel A. Beach

The friction of the battlefield often prevents units from reporting logistical requirements in a timely manner, if at all. Yet, this very activity that prevents reporting expends supplies. Does an S4 need a report to accurately predict what the needs of a troop will be? Is waiting for a troop's exact ammunition status worth delaying their resupply for hours until the S4 establishes contact? Isn't a push package of some ammunition better than none?

This article presents one successful example of a true push package logistics support system. The troop does not have to be in constant radio contact with the combat trains. Lengthy reports for required daily supplies do not clutter the Administrative and Logistics (A/L) radio net. This system allows the logistics personnel in the squadron to focus on exceptions, rather than on every detail. The S4 and support platoon leader have the flexibility to deal with rapidly changing situations inherent to cavalry operations.

The base of this system is the development of individual vehicle basic loads. The S4 coordinated with the squadron first sergeants and identified the supplies most likely consumed when deployed (see Figure 1). We developed the M1A1 and M3 POL packaged products stockage first. The high density of these vehicles (versus M109s or M106s) provided more opportunity for quick returns. They also constitute the majority of the unit's combat power.

Regular use and storage capacity were the main criteria for this. For example, putting turboshaft on each tank means crew members can add oil and continue the mission. This immediate maintenance is the converse of transmitting a request and waiting for the oil to come forward from the field trains.

The Class IV operational loading came next. Obstacle material provides each vehicle increased local security or the ability to emplace a point obstacle. Combining all mines and wire from an M3 platoon yields enough material to start a hasty obstacle. This operational load can support deliberate obstacle construction by reinforcing engineers with additional Class IV material. Three pickets are candy striped for marking fighting vehicle positions (see Figure 1).

Packing lists for the support vehicles came next. The cavalry troop and tank company each have a specially tailored Class III and V load. A separate load suits the headquarters and headquarters troop (HHT) or howitzer battery. Each driver stocks these items in his M978 HEMTT fueler's storage box (see Figure 1). Extensive training at Fort Bliss and the National Training Center

## M1A1 Class III & IV Basic Load

Quantity	Item
8	Quarts Turboshaft
4	Quarts 30W
1	Gallon FRH
1	Gallon GAA
1	Gallon CLP
2	M21 AT Mines
5	M18 AP Mines
25	Sandbags
1	Box of Trip Flares
4	Roll of Concertina
11	U-Shaped Pickets

## M3 Class III & IV Basic Load

Quantity	Item
6	Quarts 15W40
1	Gallon GAA
1	Gallon GMD
1	Gallon FRH
1	Gallon CLP
4	M21 AT Mines
5	M18 AP Mines
50	Sandbags
1	Box of Trip Flares
4	Roll of Concertina
11	U-Shaped Pickets

## M978 Packaged Product Basic Load for a Cavalry Troop/Tank Company

Quantity	Item
48	Quarts 15W40
24	Tubes GAA
24	Quarts Turboshaft
6	Gallons FRH
5	Gallons Antifreeze
1	Gallon CLP
2	Quarts OEA
24	Quarts 30WT
24	Quarts 10WT
6	5-Gallon Cans of MOGAS

Figure 1

## Class V Package for Cavalry Troops

SABOT 30				SABOT 30			
SABOT 30				HEAT 30			
25-mm SABOT 810				25-mm SABOT 810			
25-mm HEI-T 810				25-mm HEI-T 810			
TOW 9				4.2" 50 HE 46 WP			
TOW 9							
400 RDS .50 CAL	400 RDS .50 CAL	400 RDS .50 CAL	1600 RDS 7.62-mm	1600 RDS 7.62-mm	8 LAWS	4.2" Fuzes	4.2" Fuzes

SABOT 30				SABOT 30			
SABOT 30				HEAT 30			
25-mm SABOT 810				25-mm SABOT 810			
25-mm HEI-T 810				25-mm HEI-T 810			
TOW 9				4.2" 50 HE 46 WP			
TOW 9							
400 RDS .50 CAL	400 RDS .50 CAL	400 RDS .50 CAL	1600 RDS 7.62-mm	1600 RDS 7.62-mm	144 RDS 40-mm	4.2" Fuzes	4.2" Fuzes

120-mm SABOT	180
120-mm HEAT	60
TOW	36
25-mm SABOT	3240
4-2" HE	100
WP	92

.50 CAL	2400
7.62-mm	4800
40-mm HE	144
25-mm HEI-T	3240
LAWS	8
Fuzes	192

### Tank Company Round Count for Two M977s

120-mm SABOT	360
120-mm HEAT	120
.50 CAL	3600
7.62-mm	9600
Smoke Grenades	32

**Figure 2**

(NTC) confirm that these configurations satisfy the great majority of unit requirements.

The presence of 1/4-ton trucks forced the strapping of ten MOGAS cans to the top of each HEMTT fender. Current fielding of the High Mobility Multi-Purpose Wheeled Vehicle (HMMWV) leaves the 4.2-KW generator as the only MOGAS consumer. Therefore, current load plans reduce

the number of cans to six. The cans strap onto the M978 fenders without modification to the vehicle.

The 3/3 ACR system requires two Class V packages due to the number of different weapon systems in a cavalry squadron. Figure 2 depicts a troop's ammunition configuration when loaded by pallets on the cargo bed of an M977 HEMTT. Each driver loads 120-mm ammunition in a three-

to-one ratio of SABOT to HEAT. He keeps 25-mm ammunition in pure pallets and stacks them two pallets high to speed loading. TOW pallets stack two high also. Figure 2 also lists the tank company package round count.

The 4.2-inch mortar round pallet requires tailoring to arrive at the mix depicted. We did not include any illumination rounds in this configuration. This is due to the density of ther-



mal sights in the M1A1/M3 squadron. The unit commanders deemed an anti-personnel/anti-vehicle/smoke round much more valuable than an illumination round.

The objective is to provide the maximum flexibility possible while meeting the combat unit's needs. Quick transfer of ammunition requires downloading some pallets on the ground. The recovery of empty pallets was not deemed critical when weighed against the increased amount of ammunition carried. We configured the M977s nearly the same. This provides a quantity of each type of ammunition in the event enemy fire destroys one of a unit's two M977s. This also allows for maintenance losses as well.

The Modified Table Of Organization And Equipment (MTO&E) effective 16 Oct 88 authorizes the howitzer battery six 5-ton trucks. Each truck has a 1.5-ton ammunition trailer. The new document (effective 16 Sep 89) authorizes six M977s. The organic ammunition section handles the battery requirements. The battery often finds itself attached or OPCON to a DS battalion. Therefore, this independent ammunition capacity is essential. Nonetheless, the support platoon can assist in this high tonnage requirement, if necessary.

Figure 3 depicts the distribution of HEMTT assets into LOGPACs for the 1988 and 1989 MTO&Es. Vehicle readiness or combat losses may dictate the use of extra HEMTTs from the field or combat trains to fill out a LOGPAC. These vehicles return to their respective location after reloading at the ammunition transfer point. Habitual relationships between M977/8 drivers and troops/companies prove very helpful to the timely execution of the LOGPAC.

The HEMTTs located in the combat trains provide great flexibility to the S4. One option is immediate LOGPAC resupply for a troop establishing a screen. Prestock of ammuni-

## LOGPAC Breakdown

Element	M977s	M978s
I Troop	2	2
K Troop	2	2
L Troop	2	2
M Company	2	2
Howitzer Battery	0*	1
HHT	0	1
Combat Trains	4	2
Field Trains	4	4

This figure reflects the 16 Oct 88 MTO&E. The support platoon is authorized 16 M977s under this document. The howitzer battery is authorized six 5-ton drop-side trucks, each with a 1.5-ton ammunition trailer.

The 16 Sep 89 MTO&E authorizes the howitzer battery six M977s for its ammunition section. The support platoon is authorized 13. This will necessitate the use of all but one M977 from the field trains for a LOGPAC.

**Figure 3**

tion is another possibility. Augmentation of the LOGPAC sent to a troop with unusually high ammunition or fuel requirements is also possible. However, their primary use is for emergency resupply. The S4 bases HEMTT use on the current tactical situation. An offensive mission may dictate a mix of four fuelers with one troop and one tank company M977 in the combat trains. A defensive scenario would dictate two troop M977s, two tank company M977s, and one M978. Prestocking ammunition in or near battle positions is also a consideration in defensive planning. Attachments to the squadron need special attention. First sergeants must plan for the ADA platoon operating in his area. For example, the K Troop supply sergeant can transport the Stinger missiles his troop needs on his supply truck with the normal LOGPAC. This prevents the attachment's limited resupply assets from traversing the battle area unnecessarily. The ADA platoon 5-ton truck must remain in the combat trains loaded with an emergency resupply of 20-mm and missiles.

Attachments integrate easily into the LOGPAC flow if the S4 teaches them the system. Attachment leadership must also participate in the system. The unit must give a copy of the unit Tactical SOP (TACSOP) to them. Unit leaders must provide extra instruction and coaching if new arrivals are unfamiliar with the TACSOP. Time spent with the attachment logistics leader pays handsome dividends.

This system also facilitates the quick addition of Class IV support packages. Stake and platform trucks, sent by regiment to assist the squadron, move out with the LOGPAC at the normal time. The first sergeant simply leads it to his troop area, along with the rest of the LOGPAC. Attached engineers working in the area can pick up preconfigured barrier material pallets when they rotate through the LOGPAC service station. The established Logistic Resupply Points (LRPs) furnish a simple framework for positioning this material separately when time is short.

A daily meeting of the key support leaders at the LRP is essential. The CSM, first sergeants, S1 or S4, and

squadron motor officer can briefly meet to coordinate and solve problems. The S3 can send additional graphics for distribution. This simply provides another opportunity to ensure information flow.

The support platoon leader conducts face-to-face coordination with the S4 at the combat trains while the LOGPACs are with first sergeants. He eats and then replaces the platoon sergeant at the LRP. Always manning the LRP is essential to solve problems and supervise local security.

The support platoon leader/sergeant begins cross leveling HEMTT loads as they return from the forward units. This prevents each HEMTT from traveling all the way to the regimental support area with needed material still aboard. The support platoon leader can dispatch a third HEMTT to a unit with unusually high fuel or ammunition requirements as well.

Some minor weak points exist in the "push package" system. If a troop has only light contact, two full M977s of Class V may be more than is needed. A few additional rounds may end up in the first sergeant's track, in the M88 boom and strapped into bustle racks. Cross leveling between M977s at the LRP will provide another troop with needed additional rounds. At worst case, an M977 may have to return to the rear with ammunition. A unit's failure to communicate needs accurately can lead to wasted transportation assets.

The responsibility to maintain their basic load rests squarely on the shoulders of each vehicle crew. Vehicle commanders must constantly know the status of their basic load. Remind the driver to get those quarts of oil. A tired M978 driver will want to sleep instead of chasing down turboshaft or topping off his MOGAS cans. Discipline minimizes these performance problems.

The strengths of this system are many. The greatest benefit is that leaders are confident in a replenish-

ment system that fills their requirements. Taking orders from each troop for each type of ammunition and POL packaged product is unrealistic. The overwhelming majority of these requests do not change. It is unnecessary to send a request for two fuel HEMTTs each day. Units always need 120-mm/25-mm sabot, HEAT/HEI-T, TOWs, 4.2-inch, etc. Address exceptions, rather than every small detail.

The M977 driver knows how much of each type of ammunition to load upon returning to the regimental support area. He has the load plan taped to the inside of his vehicle door. The driver doesn't have to wait for the request to pass through the combat trains, field trains, support platoon leader, and support platoon sergeant. These people are concentrating on vehicle maintenance, or refitting for the next LOGPAC. This makes more time available for planning and inspecting. It also minimizes turn-around time for reloading support vehicles.

The squadron could decide to pass the maintenance reports and requests through the supply sergeant. Or, it may designate the flow of maintenance documents between the troop and squadron motor sergeants. It is important to recognize, however, that a redundancy exists that can remedy a failure in whichever the primary procedure is.

This system normally requires minimal reporting to execute. The first sergeant knows precisely what types and quantities of supplies are enroute to his troop. He knows if he has a critical issue that requires the use of the radio. He must request only exceptions. This reduces radio traffic. The system functions when distance, or the loss of a key element, disrupts communication links. An effective SOP cuts out unnecessary radio transmissions. This reduces enemy radio direction-finding opportunities. The S4 handles the exception or emergency via FM.

This system simplifies command and control. The planning process is streamlined because each element knows exactly what it will receive. LRPs along the main direction of attack can suffice if planning time is at a premium. The support platoon sergeant has more important issues to deal with than whether I Troop wanted 37 or 38 rounds of SABOT.

This push package system has served 3/3 ACR quite well. The conclusion of the squadron's NTC rotation resulted in the observer/controller's grudging acknowledgment of two successes. First, no ammunition rack was ever less than full before a battle. Second, maneuver was never inhibited for lack of Class III.

The NTC is by no means the ultimate test. It is, however, the most realistic training for combat that logistics systems receive. The standard support package that meets the supported units' requirements is an effective, flexible, and responsive resource for success. Commanders are confident that fuel, ammunition, and other supplies required for sustained operations will arrive when and where needed. That is the bottom line for tactical unit support.

Captain Daniel A. Beach graduated from the United States Military Academy in 1984. He served as a platoon leader, troop XO, and liaison officer for 3-7th Cavalry in Schweinfurt, Germany. Following the Armor Officer Advanced Course, he served as S4, 3/3 ACR. He is currently the S4, 135th MI Battalion (CEWI) and a graduate student of history at the University of Kansas.

# You Can't Push Wet Spaghetti

by Colonel John C. Gazlay, USA, Retired

The newly recruited American soldier leaves a democratic society and joins a regimented formation. His previous group experience allowed the question, "Why are we doing this?" It is against this background that American military leaders face challenges far greater than those experienced by the leadership of other free world armies.

A new soldier's career begins with drills to instill discipline and rapid response to orders. Frequently there is not time, nor is it required, to provide "WHY?" "Yes, sir," is the expected reply.

Many scholarly theories address the art and practice of leadership. History has shown that successful leaders distill theory and practical experience into a personal formula for leadership.

It is the purpose of this article to present some observations from one leader's experience in leading American soldiers.

●**You Can't Push Wet Spaghetti.** In garrison, most units are full of starch. This rigidity allows leaders to push them. Once in the field and "wet down" by fatigue, confusion, and apprehension, much of their starch disappears. These units require leadership from closer to the front...pulling. Leadership by example and through professional competence engenders willing response to pushing or pulling.

●**Who's In Charge?** Everytime you approach a group of two or more soldiers ask, "Who's in charge?" Initially, they will form a circle and point to the soldier on their right. Continued daily posing of this question to every group you encounter ultimately pays off. In the absence of orders, one voice comes through loud and clear, "This is what we are going to do. I'm in charge."

●**Catch Your People Doing Something Right.** Provide positive feedback with on-the-spot recognition of a task well done... "Good job, Jones." "Looking good, Smith." Dwelling on the negative makes soldiers "gunshy" in the presence of their leaders. Label a soldier a loser often enough and he will behave like a loser.

●**Praise Publicly, Reprimand Privately.** Praise is addressed in the preceding observation. Use a draft OER/EER as a reprimand tool. Begin the session with, "If I had to rate you today, here's what I'd write." Explain your reasons, and what specific actions will change your mind. Both parties date/sign the report and place it in a sealed envelope. The envelope is opened only when needed to support more serious disciplinary action. The departure of either signatory causes the envelope to be destroyed without having been opened.

●**An Organization Only Does Well Those Things That the Boss Checks.** When assigning a task, include all the elements, i.e., what do I want? what assets will be provided (men, materiel, equipment)? when is it to be

completed? and what are the results desired? Have the man in charge "play" the elements back to you to ensure understanding. When the allocated time has expired, return to the man in charge. "Is the task completed?"..."Yes sir." "Then you won't mind if I check."

●**When Subordinates Make the Right Decision, They Get All of the Credit. When Their Decision is Wrong, You Get All of the Credit.** This produces creative energy and, when necessary, creative risk-taking. There will be a self-generation of quality control. Be supportive of the good tries. After a wrong call, privately counsel the man in charge, "That's one way to do it, but if I had been here I might have done it this way."

●**Manage by Wandering Around.** Get out of the office/CP every day. Have a purpose for wandering around... "What am I looking for?" Being on your soldiers' "turf" opens communications. You will see and be told things that would have otherwise remained unknown to you. When units are detached, try to visit them daily... deliver their mail, food and beverages, clean clothing.

●**It is Better to Hold a Good Man Down Than Hold a Weak Man Up.** Encourage and demand initiative. Everyone should know that he is required to do something. Bridle the energy of your "hard chargers" and gently steer them on the required course.

●**You Must Always Be Your Men's Friend. You Can Never Be Their Pal.** Being a friend means you are approachable. Your answer may not always be what they want to hear, but you always listen. Being a pal breeds contempt, eroding response to orders. You can play volleyball with them during organized athletics... you can't shoot pool with them in the day room. You can mess together in the field... you can't meet them in a restaurant downtown. You can have a few beers with them during unit day... you can't drink together at the club.

None of the preceding are revelations. However, they are a collection of devices that may increase your effectiveness as a leader. If some don't work for you, discard them, and try something of your own invention. Those devices that do work for you are added to your reservoir of experience in the art of leadership.

---

*Colonel John C. Gazlay was commissioned through ROTC in 1953 from Pennsylvania State University. He commanded infantry units at platoon, company and battalion levels, and served in various staff assignments including G2/G3 advisor to an infantry division in RVN; 7th Army G-3; and operations staff officer, DA DCSOPS. He has received the Legion of Merit, Bronze Star ("V" and 2 OLC), and the Meritorious Service Medal.*

*"Some units still try to relate MILES boresight with real boresighting, but the two techniques vary greatly. As a result, many units at the NTC experience frustration when conducting training."*

# MILES Rules the Battlefield

by Sergeant First Class Richard S. Francis

3/B/1-52 Armor prepared defensive positions throughout the night. Unknown to the platoon, the enemy's axis of attack will move directly into its engagement area. After extensive preparations, the task force commander orders Bravo Company to occupy its prepared positions to await the enemy's arrival.

As third platoon's last tank occupies its fighting position, an OPFOR motorized rifle battalion (MRB) comes into view. As enemy forces enter the company's engagement area, the third platoon leader initiates his rehearsed fire command. The platoon's M1A1 tanks move onto their firing platforms to engage the OPFOR in the flank at 2,500 meters. Suddenly, the command "FIRE" is heard over the platoon net.

The tanks engage and re-engage with little or no effect. Bravo 32 engages a T-72 with five rounds and a BMP with four rounds with no effect. As the battle rages, the enemy identifies a firing signature generated by one of the platoon's tanks. This tank is Bravo 32. Within seconds, a T-72 destroys Bravo 32. The OPFOR MRB rolls through the Bravo Company engagement area to its final objective.

After the battle, pertinent data is collected and transmitted to the platoon observer controller (OC). Later, third platoon assembles for an after-action

review (AAR). Throughout the course of the AAR, the platoon members discuss what happened, and why the third platoon was unsuccessful. For the crew of Bravo 32, it was a frustrating experience, casting doubts on individual skills and eroding confidence in their equipment.

This scene occurs on numerous occasions at the National Training Center (NTC). Although the tactical lessons are learned, it may be a frustrating lesson in MILES gunnery for that one tank crew.

MILES boresight techniques for the M1A1 and M1 tank do not take full advantage of the system. For example, procedures found in TM 9-1265-375-10-1 do not verify kills at various ranges; FM 17-12-1 does not address MILES boresight procedures. One of the limitations with MILES is that the full-up fire control system cannot be used. Even the M1A1 procedures of indexing new ranges does not work effectively.

Some units still try to relate MILES boresight with real boresighting, but the two techniques vary greatly. As a result, many units at the NTC experience frustration when conducting training.

Proper MILES boresight procedures bypass the computer. Once MILES

boresight is complete, no information is entered into the computer. Because we cannot use our full-up fire control system to boresight, we must manually compensate for parallax. This is where MILES boresight and regular boresight differ.

Success on any battlefield requires soldiers to have 100 percent confidence in their equipment. Improper MILES boresight techniques have caused the M1A1 tank crew to lose confidence in its tank killing ability. Proper MILES boresight procedures will allow tank crewmen to simulate accurately the effects of the main gun in force-on-force engagements. The following checklist outlines the proper procedures to boresight MILES on the M1 and M1A1.

Sergeant First Class Richard S. Francis is a tank platoon combat trainer on the Scorpion 11 team. He has previously served as platoon sergeant in 2d ACR and 2-35 Armor at Fort Carson. He is a graduate of M60A3 and M1A1 Master Gunner Courses and has attended the Armor Advanced NCO Course.

# STEP-BY-STEP MILES BORESIGHTING

## Setup for Boresight

- Remove X-MTR and clean optics
- Index APDS
- Place X-MTR in breech. Ensure tightness.
- Look through sight and ensure it is not blocked by gun.
- Open CCP door and turn power on.
- Push crosswind button and enter 00. Push enter button. Ensure crosswind remains lit.
- Push CANT button, enter 00. Push enter button. Ensure CANT button remains lit.
- Push LEAD button, enter 00. Push enter button. Ensure LEAD button remains lit.
- Push RANGE button, enter 1200. Push enter button. Ensure RANGE button remains lit.
- Open SUBDES door, push SUBDES button, enter 1 on M1 or 59 on M1A1. Push enter and close door. (The individual setup is now in place and boresighting may now be done.)

## Close-In Boresighting

- Send one MILES operational tank with a green key out 400-600 meters from the platoon or company. (MILES boresight should be done at platoon level. The following procedures are for a platoon or a company.)
- Have the boresight tank present a frontal target.
- Have the loader look through the MILES sight and talk the gunner to the center mass of target.
- Gunner fires and confirms a kill.
- After a kill is confirmed, the gunner refers his 1200 meter line of the GAS to center of target (APFSDS-T reticle). This is done because it is the most clearly defined point on the reticle. The close-in boresight is now complete.

## Intermediate Boresight

- After all tanks in the platoon/company have finished with close-in boresight, send the tank out to 1100-1300 meters.
- Looking through the MILES sight, the loader again talks the gunner to center mass of target.
- Gunner fires and confirms a kill.
- Once a kill results, refer the TIS to center mass of tank. The intermediate boresight is now complete.

## Boresighting at Longer Ranges

- Once all tanks in the platoon/company are complete, send the tank out to 2000 meters.
- Again, the loader talks the gunner on target.
- Gunner fires and confirms a kill.  
*If all the tanks in the platoon can kill at this range, continue to send the boresight tank out in increments of 200 meters until one tank can no longer kill. Have boresight tank return to last effective kill range. This is the MILES effective range for the entire platoon.*
- Again, have loader talk gunner to the center mass of target.
- Push boresight key.
- Toggle reticle of GPS to center mass. Push enter.
- Push zero key.
- Toggle reticle to center mass. Push enter.  
The MILES boresight of main gun/coax is now complete.

## Engaging Targets

*During full-up main gun engagement, the computer will compensate for parallax. But, in MILES gunnery, we do not want any computer inputs because the laser "shoots" in a straight line, unlike a main gun round. This is why we boresight at three different ranges.*

- When targets are closer than 900 meters, or when engaging with coax, use the GAS.
- When targets are 900-1800 meters away, use the TIS.
- When targets are 1800 meters or more, use the GPS to engage.

## CAL .50 Setup

- Ensure transmitter is secured to machine gun.
- Wipe off laser optics with soft cloth.
- Put in a fresh 9V battery and key up transmitter with a green key.
- Put in orange key and turn.
- Secure a dry fire cable and hook up to transmitter.
- Send a soldier out 100 meters with a green key and operational MWLD.
- Point machine gun at soldier and fire until you kill the MWLD.  
*Have soldier stop at that point.*
- Refer .50 cal. sight. Lay off, then re-lay on soldier. Stop at that point.
- Confirm that aiming point will result in kill.
- If dry fire cable is not available, live blanks will need to be fired.

# Short Halt Maintenance

## Keeping Combat Power Rolling Forward in the Attack

by First Lieutenant (P) Bradley T. Gericke

Union Major General George H. Thomas, the famous "Rock of Chickamauga," once told his young officers that "the fate of an army may depend on a buckle." The same is true today in our Armor Force of high technology weapon systems; every component must always be in working condition. The fate of soldiers and units now rests on wedgebolts and filters, roadwheels and batteries.

Our maintenance efforts have improved in recent years, particularly in the motor pool. But what about during-ops maintenance, that critical time when there is much to do, and soldiers are alternately keyed-up or exhausted due to the stress of battle? Our doctrine calls for continuous operations, but how can we maintain equipment over long periods to ensure our combat power remains up front on the objective?

The "Iron Dukes" of 2-67 Armor solved the problem in a manner much like an Indy pit team swarms over its vehicle at the Speedway. At each operational halt, vehicle crewmen dash from one point to the next, scurrying from driver's compartment to suspension to engine. Moments later the word to move is sounded. The crewmen mentally check their list once more: refueled, filters cleaned, suspension lubed, fluids full, all is ready. They climb aboard and speed away.

This technique of rapid, yet thorough, maintenance on the move is termed short halt maintenance, a concept that arose from the need to consistently combat the harsh effects of the desert on the M1A1 during periods of continuous operations. Tankers quickly found that the "during-ops" checks from the -10 TM proved insuf-

ficient and cumbersome to access during extended periods of movement and around-the-clock operations. Likewise, crews could not expect any downtime to execute the "before" and "after" checks of the full schedule.

Short halt maintenance maximizes the quality of PMCS within the absolute minimum time afforded by high intensity operations. Although developed in the desert, the concept itself is adaptable for any type of climate. Two distinct components comprise the program.

First is a list of maintenance checks distilled from TM 9-2350-264-10, written in bullet format for simplicity (Figure 1). The particular content of this list is certainly flexible. It does not pretend to be all-inclusive, and can be modified anytime the operational tempo or maintenance posture changes significantly.

Each crew gets a copy of these checks while in the assembly area. The list should be on an index card, or affixed where it is readily accessible within the turret. A brief, back-deck demonstration for the tank commanders, conducted by the company XO and maintenance team chief, pays tremendous dividends. You may think that, as these tasks come directly from the PMCS table of the -10, no instruction is needed. However, this provides a great start point for the program, and affords tank commanders the opportunity to ask questions. In this way, everyone on the team will know the standard. More

about execution of these checks later.

The second component for success is a clear priority of work established by the chain of command. Tank crews can then rapidly translate their leaders' guidance into aggressive maintenance on the ground.

As the tank company rolls to a stop, whether it be for ten minutes or an hour, the commander or executive officer must prioritize and quickly publish a maintenance effort that is sharply focused, based upon the estimated length of stay, recent maintenance accomplished, and upcoming operations. Other important activities will compete for your time: refueling, orders updates, and feeding must all be accomplished. The maintenance order may be given on the ground or over the radio, using the number of

### Short Halt Checks

1. Inspect roadwheel hubs
2. Clean engine and transmission oil coolers
3. Blow V-Packs and precleaner
4. Check scavenger fan and hose
5. Check fluids
6. Inspect and brush heat exchanger
7. Inspect rear grilles and seals
8. Field strip and clean weapons
9. Walk track
10. Sweep back deck
11. Dust radios
12. Clean turret interior
13. Clean ammo door rails
14. Check and clean batteries
15. Clean and inspect wind sensor
16. Dust optics, vision blocks and MRS
17. Dust fire extinguisher sensors
18. Inspect and clean NBC equipment

Figure 1

the check for brevity. Another method is to publish the maintenance priority of effort for short halts in the OPORD. The minimum goal is to complete your list daily.

A typical short halt may unfold like this:

A company has been on the move for the last three hours. Five miles from their current location, the task force is going to halt for not longer than ten minutes to give commanders a new map overlay. Knowing this, the company XO radios on the company net, "All Blue elements, this is Blue 7. At next halt, execute checks 1, 5, 7, 14, 15, and 17. Priority to 1 and 14. Length of halt ten minutes. Out."

Tank crews will soon anticipate this guidance and develop the skill to transition rapidly from tactical operations to productive maintenance work with a minimum of disruption. The time spent at the halt will, therefore, be fully utilized with productive activity that supports the maneuver plan. No time is lost while crews mill around seeking information.

In executing the checks, adherence to the procedures outlined in the -10 is the rule of thumb. The purpose of short halt maintenance is to emphasize and supplement during-ops checks, not to deviate from the TM



standard. However, certain checks may require specific practice before crews become proficient under field conditions. The process of blowing the V-Packs and pre-cleaner is one of these and bears mention.

In a dry, dusty environment, blowing the V-packs becomes a critical and time-consuming process. There is definitely a right way and a wrong way to do this.

A good technique is to have one wand and two base attachments in each platoon, so that each platoon is self-sufficient. One tank may blow out

the other three, then switch wands to the tank with the second attachment to have its own packs blown. Of course, a tank must never attempt to blow out its own packs! Ensure that your crews are reminded.

As much as possible, blow the dust from the inside to the outside of the filters to prevent dust from being blown through the material of the filter element. Wear gloves to handle the wand, and do not blow the packs on the back deck. Place them on a tarp or cloth on the ground to preclude further dust settling in the engine. Finally, replace the V-Packs in the exact sequence they held before cleaning. This ensures a better seal. The amount of dust and dirt that comes out of each V-Pack after a few hours of running in the desert is amazing.

As the example of the Indy pit team illustrates, the aggressive spirit of short halt maintenance applies any time the tank is not moving. Such an attitude fosters crew pride and teamwork. Caring for the tank becomes second nature for every soldier, a comfortable, instinctive routine which ensures that our combat power is constantly prepared to fight.

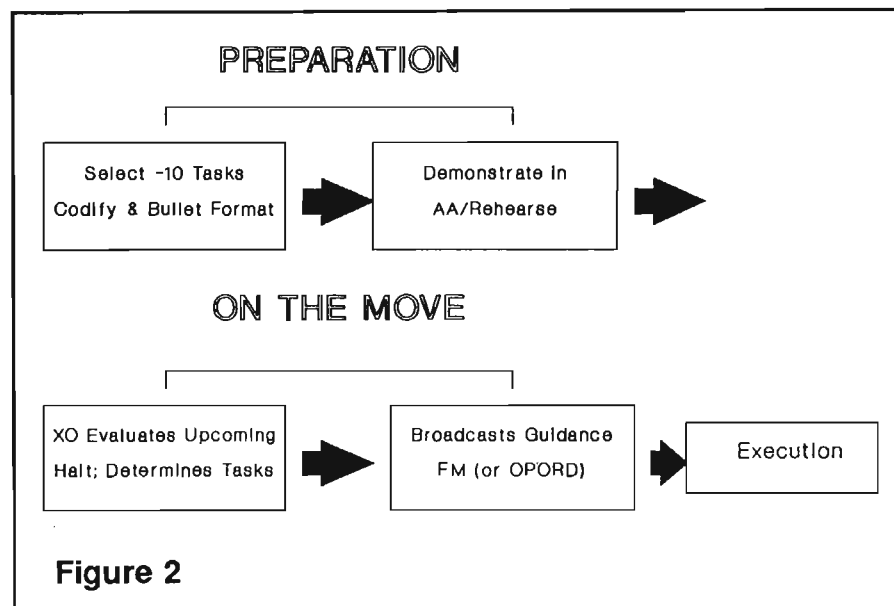

First Lieutenant Bradley T. Gericke is a 1988 graduate of the United States Military Academy. He has completed the Armor Officer Basic, Air Assault, Jungle Warfare, and Airborne Courses. He served as a tank platoon leader and tank company XO with 2-67 Armor, 3AD, Friedberg, Germany. While in Iraq after DESERT STORM, he became the battalion S1, 2-67 Armor, his current position. He is scheduled to attend AOAC this fall.



At left, the Abrams Auditorium dedication. General Abrams is seen at right as U.S. MACV commander in Vietnam, July 1968.



## Remarks at the Dedication of the Abrams Auditorium, Patton Museum of Armor And Cavalry

*This is the text of the dedication speech by General Donn A. Starry U.S. Army, Retired.*

Today, we have the happy task of dedicating this superb new auditorium addition to the Patton Museum of Armor and Cavalry to the memory of General Creighton W. Abrams, Jr. It is ever important that an army remember its heroes. But it is also important that we not only memorialize our heroes, but that we do so in such a way that their legacy to us survives the memorialization; in other words, it is not just a matter of naming some place or thing after those we seek to memorialize. It is a matter of doing so in such a way that we are continuously reminded, and so ever mindful, of the lessons they taught us.

Like any famous man, General Creighton Abrams is different things to different people, depending on the vantage point from which his service is viewed.

- Those old enough to remember World War II may remember him leading the 37th Tank Battalion and the 4th Armored Division in the relief of besieged Bastogne.

- Early post-war students at the Armor School surely recall him as head of the Command and Staff department, hard at work digesting the war's lessons into doctrine for armored forces for the next decade, perhaps more.

- For those of us who were there, he is vividly remembered as commander of the 63rd Tank Battalion, 1st Infantry Division, as the Korean War fired up and tensions in Europe bounded upward.

- Again, to those of us who were there, he is remembered as 3rd Armored Division's steadfast commander as we sought to react in some relevant way to the sudden appearance of the Berlin Wall.

- Whomever remembers the civil disorders in Oxford and Birmingham in the civil rights years, remembers him as the guy in the rumpled seersucker suit who became Robert Kennedy's man on the ground.

- Many of us recall his post-Tet strategy for South Vietnam, and his conviction that, given the means, the South Vietnamese could go it alone.

- All of us surely remember his all-too-brief tenure as Chief of Staff, his determination to rebuild our Army in the face of a reduction mania not at all unlike the one thrown up before us daily in our so-called post-cold war time.

In all those assignments, and more; in all those crises, his professional performance was more than sufficient to cause us to memorialize him.

But I have a somewhat different perspective of General Abrams, and I believe it worth reflecting on for these few moments. For I remember him for what he taught me; for what he taught

all of us, especially those of us who served for him in many capacities, many times. For he represents, together with perhaps but one other officer in my lifetime, the character we strive to infuse into Army leadership in schools like the Armor School.

My own perspective is drawn from a 25-year association with General Abrams. I was a platoon leader, part-time company commander in his battalion; a brigade operations officer and battalion executive officer in his division; a battalion commander in his corps, a regimental commander in his command in Vietnam. As his staff officer in Vietnam, I wrote the plans to Vietnamize the war. As his staff officer in the Pentagon, I presided for him over post-war restructure of the Army. As TRADOC formed up in 1973, he sent me to command Fort Knox, with the parting admonition to, "Go out there and get the Army off its ass." It was a charge he laid on many, I'm certain; but to me it had a personal ring, for knowing him so well, I knew precisely what he meant, and that he was holding me responsible for more than my fair share of whatever got done.

So, as one who has spent a considerable part of a lifetime trying to meet the demanding standards of a man who accepted no less than the highest in performance, I bear the scars of our long association. Despite that — perhaps because of that — I hold him in



the highest regard; for what he did, for what he stood for, for what he was. For my view of him is that he embraced a very few simple values, in which he believed deeply, and to which he returned again and again in everything he did. Moreover, I am convinced that those very values are at the heart of what we, following his example, would imprint in the corps of leaders of the Armored Force who pass all too briefly this way periodically.

Above all, General Abrams put the highest premium on the professional competence of leaders. He was, as our battalion commander, the best tank commander in our battalion. He delighted in showing us, by example, what he expected us to know about being tank commanders.

Too well do I remember a long period of study in tactics, terrain, and map reading. George Patton and I endured after the two of us had attacked, with great zest, the wrong hill in a live fire exercise, in plain view of our battalion commander, watching from his own tank.

My wife reminds me of the .50-caliber machine gun that hunkered down on our living room floor for several weeks after Colonel Abrams found that some folks in our battalion weren't too well trained in its use. His view was that the fault lay with the leaders not knowing that weapon well enough, and so not training the soldiers well enough. So we learned to do it blindfolded. I believe I could do it that way to this day.

As a trainer of soldiers and units, he was a tough taskmaster. Not because he had some kind of training fixation; but because he believed that from tough, demanding training comes the sure ability to fight well and win on the day of battle, even though outnumbered and against weapons about as good, perhaps better, than our own.

He believed that soldiers will do well in battle only what they had been trained to do to perfection before battle's onset; and that the primary re-

sponsibility of leaders is to lead the way in that training. Know your job, he would say, but it was quite clear that, to him at least, it was no job, it was a calling.

So much of him can be summed in one word: courage.

He blew the whistle when he found a few soldiers in his battalion selling nearly a hundred thousand gallons of gasoline on the black market every month; he tracked the problem to the source and brought the offenders to trial. Courage.

He tackled, without flinching, the powder kegs in Oxford and Birmingham.

He believed in the South Vietnamese, and stood forth for a program that would enable them to survive on their own.

He agonized at the sure outcome of post-Vietnam reductions in preparedness, and spoke eloquently so many times of the price inevitably to be paid for our folly in the lives of soldiers in the first battles of the next war. Courage.

He had the courage to let his subordinates falter, and to pick them up and start things aright; the courage to stand between his subordinates and higher headquarters witch hunters.

He had the courage of good humor. He had a subtle, almost pungent wit. He liked a good story, liked to tell a good story. But there was more to it. Listening closely, most of those stories were about himself; things he'd done wrong, times he'd got caught short. They were humbling stories. I came to believe he liked to tell them because they reminded him to be humble. For the mighty to be humble requires the ultimate in courage. Know yourself, he would say. And be humble for the knowing. Courage.

One of General Abrams' most quoted statements is his observation to a congressional committee that people are not *in* the Army; people *are* the Army. His was a deep and abiding concern for soldiers. Many of us are

concerned about soldiers, but his was a special kind of concern. I do believe he sincerely liked people, but his overriding concern was that the soldiers be capable in the face of the tough tasks of battle. He was a tough trainer — some of us at the time considered him almost merciless, especially on leaders. He was that way because of his certain conviction that we all need be well enough trained, not only to survive in battle, but to survive and go on to win.

In many forums, before so many audiences, he reiterated all or parts of that marvelous speech he delivered to the AUSA convention in Washington, the one in which he cited the tremendous price our country has traditionally paid for unpreparedness. He sized that price in terms of the cost to the nation in the resource it could least afford to expend — the lives of its young men. Always the soldiers. Know your men, he would say, and be ever watchful of their willingness and ability to survive and to go on to win, whatever the odds, whatever state shortsighted reductions in force had brought us to at the onset of battle.

Through everything he did shines those abiding values: strength of professional excellence on the part of leaders; courage to face the dangers of battle, and courage to face the more subtle but equally threatening dangers not always found in battle itself; deep faith in the soldiers, and concern that they be well enough trained and led to avoid unnecessary casualties in battle, and that the nation be sufficiently prepared that its soldiers not be foolishly sacrificed because we lack political resolve to pay the price for peace. That's what I learned from him. That is what he taught me.

That is his legacy to us. His name on this marvelous auditorium will continue to remind us of those lessons. He will teach generations anew what he taught all of us. Let us hope that we learned as well as he taught.

Thank you.

and recovery section, who volunteered to return on successive weekends without pay. The training ran regardless of weather and included the first mounted night training with night vision devices any part of the regiment had ever conducted. Our reenlistment rate went to nearly 100 percent, representing retention of soldiers who had completed their legal military obligation.

All of this was reported in *ARMOR* (March-April 1962) and in what is now *National Guard* (January 1962) and led to abandonment of the evening drill in favor of the present weekend training.

Colonel Clarke takes the matter another big step forward. He recognizes that, as in the Idaho and Pennsylvania experiments, facilities and logistics are the keys.

Colonel Stouffer started in the 104th as a horse trooper, and he lived the regiment's motto, "Over, Under or Through." From some distant ridge, most assuredly once again horse mounted, I suspect he sees in Colonel Clarke a kindred spirit....

WILLIAM V. KENNEDY  
COL, Armor, AUS, Ret.  
Wiscasset, Maine

### Improve Guard/Reserve Training By Focusing on Basics

Dear Sir,

All these ideas on how to improve the training of Reserve/National Guard Armor/Cavalry units fail to correct basic problems.

•The tanks are not capable of sustaining training for more than two or three days without a 20- to 70-percent deadline rate. In 12 years, I have yet to see the National Guard repair a deadlined tank in less than three or four days, and have often observed a tank deadlined on the first day of annual training be towed in at the end of annual training. Crews will operate tanks with major system failures, just so they can train. There are so few fully operational tanks that crews rotate on them for gunnery. I have not fired a tank I drew since 1987.

•Gunnery should be fired during annual training. Crews need time together ON THEIR TANK. Firing Table VI the day before VII/VIII makes a big difference. Since transition in October 1990 I have had less than 10 hours practice time on the M60A3 before firing VIIIA in April 1992. I did not fire VIIIB because intruders in the range fan delayed firing until the 2200 locally-imposed ceasefire time. It had been two

months since I was on a tank, and four for my gunner. We got 4 to 7 hours tank operation on a weekend, with the remaining hours used for travel, draw, cleanup, turn-in, details, and equipment accountability. All too many people run on three to five hours sleep a day, and are exhausted when they arrive for drill. By Saturday night/Sunday morning, safety is a real serious problem, so operations slow down.

•Our equipment is so old that some of the Active Duty advisors do not know how it works. Soldiers coming off Active Duty have to be de-trained on our older tanks.

•National Guard divisions are going to reorganize. Existing Armor and Cavalry units will convert to something else, and other units will convert to Armor/Cavalry. It takes about five years to completely retrain a unit. (I went through this.)

•Soldiers attending schools can miss up to four months of drills or annual training (20 to 40 percent of available training time, equivalent to 10 to 21 weeks of an active duty unit's time). This is going to get worse with the budget crunch.

To upgrade National Guard training, make replacement parts available in a few hours, make annual training three weeks, cut some drills down to one day and lengthen single-day drills to 2100 hours, have the armories next to the tanks and make their upkeep the unit's responsibility, speed up conversion to new equipment, and do not convert existing National Guard Armor/Cavalry units.

CHRISTOPHER F. SCHNEIDER  
SSG, Armor, Indiana National Guard



## WARNING ORDER Future Main Battle Tank Design Contest

The U.S. Armor Association is planning a Future Main Battle Tank (FMBT) Design Contest. What do you think a main battle tank in the Year 2010 should look like? What should it be able to do? How would you design the tank of the future? Would it be heavy or light? How many crew members? Does your idea include Stealth or super speed? How "air transportable" should it be?

These are everyday questions considered by tank developers all over the world, and now you can tell the Armor community how you would design a tank that would be used on the 2010 battlefield.

Details of the contest are being formulated by the Armor Association and the U.S. Army Armor School. So, start writing down ideas and making sketches. Prizes will include cash awards, one-year honorary memberships in the U.S. Armor Association, and honorable mentions.

We are looking forward to good ideas for a follow-up to the Abrams when it reaches its 25-year production anniversary, so stretch your imaginations. (Do not call for information now. Details will be announced later.)

## Commander's Hatch *(Continued from Page 4)*

Center this fall with the 1st Cavalry Division. This tank is the first third-generation tank to be fielded in the world. It revolutionizes mobile armored warfare and will serve as our bridge to the future. Our far-term target is the future main battle tank. We expect it to be in the 50-ton weight class and hope to have it fielded by the second decade of the next century. To get your ideas, the Armor Association is sponsoring a Future Main Battle Tank design contest. For the near term, and for the next two decades, we will pursue a comprehensive and continuous program of modifying and improving the Abrams to ensure that it remains the world's premier tank. Armor soldiers will see the Abrams grow to include onboard navigation, independent thermal viewers for the tank commander, and the installation of an auxiliary power unit and self-cleaning air filters.

•The quality of the Armor leader and soldier remains very high. Commanders of all branches in DESERT STORM were unanimous in their praise of the competence, resourcefulness, tenacity, and flexibility of the Armor soldier, NCO, and officer. By all indicators, that excellence will continue. New recruits entering tank and scout one station unit training have the highest aptitude scores in history. Their enthusiasm and spirit reflect their solid records of success as students and athletes, as well as their intense desire to join the fast moving and challenging life of the Armor and Cavalry trooper. Many will aspire to and join the ranks of our high quality NCO Corps. The quality story is the same in the officer ranks. Never have so many cadets from ROTC and USMA put Armor as their top choice of branch. Armor will continue to build on a solid foundation of top quality people.

•Armor is maturing as a true total force. Several major initiatives are underway to ensure that, when the Armor Force next goes to war, it will be as a full partnership of National

Guard, Army Reserve, and Active Army organizations. Fort Knox is one of the prototype National Guard Regional Training Centers, starting this summer. During its active training period, the 2nd Battalion, 252nd Armor will negotiate an unprecedented program of individual, crew, and small unit lane training prepared by Readiness Group Knox and based upon the lessons learned in the DESERT STORM mobilization. Much of the training will be conducted by the 100th Division (USAR), which plays a key training role in both the peacetime readiness and the wartime mobilization of the Total Armor Force. All this is part of the Army's Bold Shift initiative to enhance the readiness of the Total Force. The Armor School is also one of the key players, along

---

***Our nation will continue to look to Armor as the arm of fast-moving maneuver and decisive action. We will be expected to continue to prepare, as we always have, for the day we are needed to carry firepower and shock effect to the heart of our enemies.***

---

with the National Guard Bureau and the Defense Advanced Research Projects Agency, in adapting the newest breakthroughs in the science of virtual reality to the training of our units at their armories and even in their homes.

We also announced at the Armor Conference the formation at Fort Knox of the Mounted Warfighting Battle Space Laboratory. Over the next few years, this special task force will create, refine, and explore new concepts in what we refer to as the battlespace dynamic for brigade and below. Using simulation and actual testing and experimentation, we will explore the challenges and opportunities we see emerging on the future battlefield. Our work is not just for Armor and Cavalry, but for every branch of the mounted combined arms team. The Mounted Warfighting Battle Space Laboratory will identify the

requirements for the future in the areas of doctrine, organizations, training, leader development, materiel, and soldier support. For example, we are already examining the payoffs of linking the new intervehicular information system that is on the M1A2 tank with the OH-58 scout helicopter, and the Bradley Fighting Vehicle. The Mounted Warfighting Team is already hard at work on this exciting and historical mission with our counterparts at the other TRADOC schools and with the Army Materiel Command.

This year's Armor Conference confirmed that now is a time for Armor soldiers to be optimistic and confident. The unpleasantness of downsizing and inactivating is a reality that we will work our way through. The Army has a plan, and it is being implemented. Promotion and leadership opportunities will improve in the near term. Soldier quality will remain high. We will capitalize on the very latest technology, and we will also expand our light armor and cavalry capability for the Total Armor Force.

Yes, the future will have many new and exciting features, but it will share one constant with the past. Our nation will continue to look to Armor as the arm of fast-moving maneuver and decisive action. We will be expected to continue to prepare, as we always have, for the day we are needed to carry firepower and shock effect to the heart of our enemies.

It has been a great honor, privilege, and adventure to have served as the 33rd Chief of Armor here at the Home of Mobile Armored Warfare for these last three years. My pride in our victories in the Cold War, in Panama, and in the desert has been boundless, and my pride in the quiet excellence of the Armor soldier has been the bright spot of every day. I leave the Army with great confidence for the future, and charge every man who wears crossed sabers to guard this tradition and this reputation vigilantly.

**FORGE THE THUNDERBOLT!**

## The U.S. Army Armor Center Wants Your Ideas

Your past and future military experiences represent an extensive source of ideas on how to improve our Armor Force. To demonstrate the potential of your ideas, the Armor Center established the THUNDERBOLT Program.

What is the THUNDERBOLT Program? Implemented in October 1988, the program provides the means to gather ideas and suggestions, to evaluate their potential benefit, and to process these ideas into actual results. With existing test and evaluation resources and YOUR ideas, many common problems can be resolved. A considerable number of THUNDERBOLT suggestions relating to armor and cavalry tactics, training, and hardware have been approved for implementation.

The exact nature of your idea is not important. What is important is its potential to benefit the Armor Force. We solicit your ideas relating to:

- the redesign or modification of existing equipment or operation procedures;
- a new piece of equipment;
- changes to unit structure or its equipment;
- an innovative training method;
- an effective application of tactics.

The THUNDERBOLT Program's primary focus is toward low cost, easily applied fixes; however, all proposals will be considered. Proposals which might exceed the scope of THUNDERBOLT will not be ignored, but will be routed to the appropriate office or agency having action authority. Submitting your ideas to the THUNDERBOLT Program will not preclude you from being eligible for an incentive award through the Army Suggestion Program or the Model Installation Program. It may, in fact, increase your chance of success.

The format you use to provide us your ideas is not important — just that you submit them! Include any picture, sketches, or example you might have. Send your ideas, suggestions, or proposals to: Commander, U.S. Army Armor Center and Fort Knox, ATTN: ATSB-CDE (THUNDERBOLT), Fort Knox, KY 40121-5215.

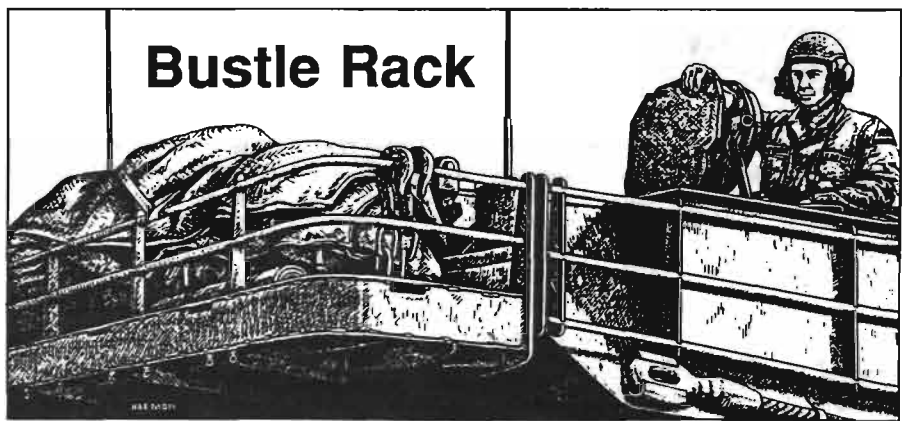

### Armor Hotline Adds 1-800 Service

The U.S. Army Armor Center and Fort Knox has enhanced the Armor Hotline with a toll free service (1-800-525-6848) for CONUS users. The number will connect callers to the 24-hour answering machine that serves as the Armor Hotline. The following numbers may also be used to reach the Hotline: DSN 464-TANK or Commercial (502) 624-8265.

The Armor Hotline may be used to call in questions or retrieve messages from Armor Center organizations. The initial greeting on the Hotline provides callers with a list of organizations and subject areas that may be selected with touch tone phones. Callers using rotary dial phones will not be able to access the voice mailboxes; they will be asked in the initial greeting to stay on the line and leave a message. Important Armor messages will be placed in the initial greeting so that rotary dialers will receive this information.

Callers are reminded to leave their name, rank, unit, phone number, and address when they leave a message. Additionally, callers should remember that the Armor Hotline is unsecured. Classified information cannot be left on or retrieved from this line. POC is Mr. Schaffner, DSN 464-1543.

### CAC-TNG Wants Comments on FM 25-101

Combined Arms Command-Training (CAC-TNG) at Fort Leavenworth, Kan., is the proponent for Army training management doctrine contained in FM 25-101, *Battle Focused Training*. CAC-TNG is looking for suggestions on how to improve the manual prior to its next scheduled rewrite. Suggestions should include the specific page/paragraph and specific recommendation to include textual changes or additions. Those wishing to provide recommendations should provide their comments to Deputy Commanding General for Training, Com-

bined Arms Command, ATTN: ATZL-CTT, Ft. Leavenworth, KS 66027. Comments may be faxed to DSN 552-4458. If you have any questions, contact CPT Bill Hedges, DSN 552-3919.

### Official File Request Option Added to Phone Access

The U.S. Army's Enlisted Records & Evaluation Center will provide NCOs a copy of their official file. Personnel records will be mailed to soldiers at their unit of assignment mailing address. The official file request is the latest addition to existing interactive voice responses available to NCOs.

Since March 1990, NCOs have been able to obtain the date of their official photograph and the end-date of their last evaluation report.

The new option allows NCOs to validate information on documents available to Army centralized promotion boards.

Callers will be asked to provide a Social Security Number. As many as five numbers may be entered.

To select one of the options, call DSN 699-3714 or commercial (317) 542-3714. A push-button tone phone is required.

Four options are presented:

- For complete board information, press 1, followed by the number (#) symbol.
- For photo data only, press 2, followed by the number symbol.
- For NCO evaluation, press 3, followed by the number symbol.
- For OMPF request, press 4, followed by the number symbol.

NCOs should allow sufficient mail time for the receipt of the official records. In the event of a recent transfer, allow time for the Enlisted Master File to reflect an updated unit of assignment.

As always, NCOs may submit a written request for a copy of their official files. Send a signed request to: Commander, U.S. Army Enlisted Records & Evaluation Center, ATTN: PCRE-RF, Fort Benjamin Harrison, IN 46249-5301.

German PzKpw III tanks ford a river in Russia in 1941.



*A new WWII history argues that Hitler planned a long siege to conquer Russia, when he could have won quickly.*

## Rethinking German WWII Strategy

**Hitler's Panzers East: World War II Reinterpreted** by R.H.S. Stolfi, University of Oklahoma Press, Norman, Okla., 1992, 286 pages, \$24.95.

Seldom does a book challenge basic assumptions about something so established as Second World War history. Stolfi's book does just this. The traditional interpretation of the German image of war, and Hitler's image of war in particular, is one of blitzkrieg, an intentional attempt to win quick victories.

Stolfi instead detects a clear pattern within Hitler's thinking — and in the decisions he forced on the General Staff in 1939, '40, and '41 — of the operation of a siege mentality. Stolfi focuses on the BARBAROSSA campaign of the summer of 1941 to prove his point. He contends that, if the General Staff's realization that blitzkriegs were possible was supported politically by Hitler, Germany would have won the war in the late summer or early autumn of 1941.

He briefly reviews the planning process that led to the Manstein Plan Yellow attack on France. That review illuminates the hesitant attitude of both Hitler and the General Staff in assuming an attritional war against the west. Manstein's plan was a distinct

break with this attitude, and its dramatic success was a surprise to both sides.

Stolfi examines the planning and prosecution of the BARBAROSSA campaign. He makes it clear that the General Staff had begun to realize that the Wehrmacht was capable of conducting successful blitz campaigns, perhaps even of defeating the Soviet Union in a single effort. Their plan was designed to accomplish just that.

The General Staff focused on the Red Army and the political centers of the Soviet Union. Their plans were well thought out and balanced appraisals of the chances for success. Stolfi demonstrates, through the extensive use of the German's own estimates, that they did not underestimate the potential of Soviet resistance.

However, Hitler's siege mentality was also apparent in his direction that the primary objectives of the offensive be economic targets. His obsession with such targets as Leningrad, the Baltic, the Ukraine, and the Donets Basin clearly demonstrates that he was thinking, not in terms of gaining quick victory, but rather of strengthening Germany's position for a long war of attrition.

This failure to agree on the objectives for the campaign was the cause of Germany's failure to knock the Soviet Union out of the war in the fall of 1941, and led directly to

the eventual defeat of Germany in the Second World War. The author contends that the traditional turning points of the war in Europe — Stalingrad, El Alamein, and Kursk — were anticlimactic episodes. The turning point of the Second World War was, in the author's view, the decisions taken in the summer of 1941 to concentrate first on the advance to Leningrad and then the Ukraine.

Stolfi does not neglect the logistical arguments. He goes into detail attempting to prove that the German Army was capable of launching the TYPHOON offensive in August and seizing Moscow in September of 1941. His case that the Soviets were on the verge of military collapse in August is plausible and convincing. The discussion of the importance of the Moscow region to the Soviet war effort is well documented with numerous charts and maps.

Historically, this book will force us to take another look at how we interpret German strategy and effort in the Second World War. Hopefully, other scholars will respond to Stolfi's arguments. Although convincing, other views of Stolfi's thesis are needed. This book is important, if for no other reason than it forces us to think through the possibilities.



At left, tankers in a Polish light armor unit at the onset of the war. Below, an antitank gun crew prepares to fire.



*No, Polish Horse Cavalry Didn't Charge Tanks...*

## Untangling Myths And Undoing Propaganda About Poland's Fight in WWII

Stolfi's thesis, if accurate, should stimulate a fresh look at the Wehrmacht. It appears even more effective than the commonly held view. If this is true, we have not yet begun to truly understand how the Wehrmacht achieved the level of success it did.

The discussion of the failure of political and military authorities to come to an agreement on the objectives of the campaign present meaningful lessons on the integration of the two spheres, even today. The political and military integration implicit in AirLand Battle doctrine is not easy to accomplish.

Whether the political leadership is that of dictatorial Nazi Germany or the democratically elected leadership of the United States, the political-military integration is the key to success or failure.

Rather than steal the author's thunder in this review, I encourage you to read the book. This one is a must-read for every thoughtful senior officer and noncommissioned officer in our Army.

SFC JOHN T. BROOM  
U.S. Army Armor School  
Ft. Knox, Ky.

**The Polish Campaign 1939** by Steven Zaloga and Victor Madej, Hippocrene Books, New York, 1991, 195 pages, \$11.95 (paperback).

Although more than 900 books and articles have been written on this topic, this is the first major work in English to explain the genesis and conduct of the campaign with a Polish view.

This five-week campaign, 1 September to 6 October, commonly known as the start of World War II, has been a victim of major historical inaccuracies, according to the authors. They cite a variety of myths and distortions "more reminiscent of German wartime propaganda than serious scholarship."

Foremost among the myths is the "rubbish" about Polish cavalry charges against German tanks. This often repeated account, first reported by Italian journalists as German propaganda, concerned an action by the Polish 18th Lancer Regiment near Chojnice. Two Polish cavalry squadrons surprised and wiped out a German infantry formation with a mounted sabre charge.

The story arose because some German armored cars appeared and gunned down 20 troopers as the cavalry escaped. Polish

mounted cavalry units, distinguished since their days of Napoleonic service, were used for scouting, screening, and reinforcements.

Other myths that the authors address:

- Contrary to popular belief, the Polish Air Force was not destroyed on the ground the first day of fighting. In fact, according to Zaloga and Madej, the Luftwaffe was "surprisingly ineffective" in striking Polish air units. The record of Polish flyers who escaped and fought with the Royal Air Force was a "distinguished one by any measure."

- The Poles had wanted to mobilize much sooner, but delayed at the insistence of the French and British, who feared mobilization would provoke Germany. The Germans, however, did not succeed in gaining tactical surprise as some historians suggest, say the authors. Poland's defeat was inevitable so long as France and Britain avoided engaging invading German forces. Even under favorable conditions, argue the authors, Poland could not have resisted the German threat singlehandedly.

- While the Polish armored forces would not compare with those of Germany or the Red Army, it was large, and "in some respects, more modern than tank units in the United States at the time."

*Of particular interest to armor officers are descriptions of one of the rare cavalry vs. cavalry engagements of the war and the largest tank vs. tank encounter of the campaign. Although armor played a subordinate role in the campaign from the Polish view, they insist that Polish tactical antitank policy was "sensible and vigorously pursued."*

• Polish troops fought as well as the German infantry when the odds were even, and better than the French and British once they engaged in 1940. Of the 1.1 million Polish mobilized in 1939, 320,000 died during the war — half of these in the September campaign. Polish troops continued fighting after Poland fell; their scattered forces making up the fourth largest Allied army by the end of the war.

While much of the book defends the Polish situation at the time of Germany's invasion, it still offers a balanced presentation. Polish handicaps during 1939 were the lack of operational mobility and poor communication and control, say the authors. Polish High Command was surprised by the speed of the Panzer division and shocked by the intervention of the Red Army against Poland.

Zaloga, a professional defense analyst, and Madej, a World War II specialist, have written a highly readable book. Accompanying details of the campaign are sections on Polish Army organization, operational doctrine, equipment, a combat chronology, and orders of battle.

Of particular interest to armor officers are descriptions of one of the rare cavalry vs. cavalry engagements of the war and the largest tank vs. tank encounter of the campaign. Although armor played a subordinate role in the campaign from the Polish view, they insist that Polish tactical antitank policy was "sensible and vigorously pursued."

THOMAS J. VANCE  
Major, USAR (IRR)  
Kalamazoo, Mich.

**Front and Center: Heroes, War Stories, and Army Life** edited by L. James Binder. Brassey's (U.S.), New York, 1991, 250 pages, \$32.00 (hardcover), \$15.95 (softcover).

The Association of the United States Army (AUSA) has compiled some of the best articles from *Army* magazine, its official publication. The result is *Front and Center*, a book that offers hours of professional reading that is educational and entertaining at the same time.

Many of the stories are humorous; in "Private Minelli Assumes Command," we learn the incredible story of doubtlessly the lowest-ranking soldier ever to command a DIVARTY. The "real leader" type described in "Mustaches" will be recognized by most soldiers who have met at least one leader displaying the described traits (or recognized those traits in themselves, as the case may be).

George M. Hall's biographical sketch of Major General Adolphus Washington Greely is an informative look at a soldier who, although celebrated in his day, has fallen into relative obscurity as of late. "Harry S. Truman, Cannoneer" details the little known military career of America's 33d president (a man despised by many for his relief of General of the Army Douglas MacArthur during the Korean War). The story of CW4 Michael J. Novosel, who left an airline job and a Air Force Reserve Commission as a lieutenant colonel to become the oldest Medal of Honor recipient of the Vietnam War, is sure to impress.

All leaders, whatever their rank, should learn from "An Order From Override Eight" that offhand comments made without thought can have a profound impact on how much (or how little) our soldiers perceive we care about them. "Daryl's Last Christmas" is the touching story of a soldier's family learning that he has made the ultimate sacrifice.

*Front and Center* should be a welcome addition to the library of any soldier or military buff. It is genuinely fun to read, but the topics covered are broad and enlightening.

CHARLES A. COLLINS, JR.  
2LT, Armor, SCARNG  
Myrtle Beach, S.C.

**Terrain and Tactics** by Patrick O'Sullivan, Greenwood Press, New York, 1991, 182 pages, \$42.95.

This book is like a bad meal at a good restaurant — undercooked, poorly seasoned, and way overpriced. As a topic, the relationship between terrain and tactics is a fertile area, rich with historical application and imagination. Unfortunately, Mr. O'Sullivan's latest book offers little that is new or useful.

As a professor of geography at Florida State University, Mr. O'Sullivan has already produced a much better book on this subject, *The Geography of Warfare*, written with J.W. Miller. *Terrain and Tactics* is a distinct second to the earlier work. This is a scholarly book, written with dry, academic prose, given to occasional antiwar sarcasm. Referring to General Custer's 7th Cavalry as "imperial troops" is a good example. Mr. O'Sullivan proudly states in the first chapter that his purpose is to show that war is immoral and futile.

Using the backgrounds of recent wars, the book attempts to analyze the use of terrain and tactics through O'Sullivan's military terrain considerations of key terrain, avenues of approach, obstacles, points of observation, fields of fire, and cover and concealment (sounds like KOCOA to me). This is an interesting approach to modern battlefield analysis, but is not fully developed. He devotes much of the book to terrain analysis in guerrilla and counterinsurgency operations and in urban combat. The final chapter is focused entirely on terrain and tactics in Northern Ireland. Most troublesome to the reader will be O'Sullivan's use of geometrical representation and statistical analysis of terrain characteristics to predict the winner or loser in a guerrilla war, based solely on terrain factors such as slope and rainfall. The human element apparently plays no part in his evaluation.

Despite the book's significant shortcomings, there are some pearls of wisdom. O'Sullivan reminds us that weapons technology changed our use of terrain, not vice versa. In modern warfare, airspace must be recognized as a part of military geography. Terrain itself is good or bad, depending on its use for offense or defense. What O'Sullivan does not emphasize is that terrain itself does not win or lose a battle — the people who use or fail to use the terrain wisely do!

O'Sullivan's premise that rural guerrilla wars and combat in urban areas will predominate in future conflicts is certainly reasonable and agreeable. The price and content of this book are neither. Read it from the library, but save your money.

W.D. BUSHNELL  
COL, USMC  
Shawnee Mission, Kan.

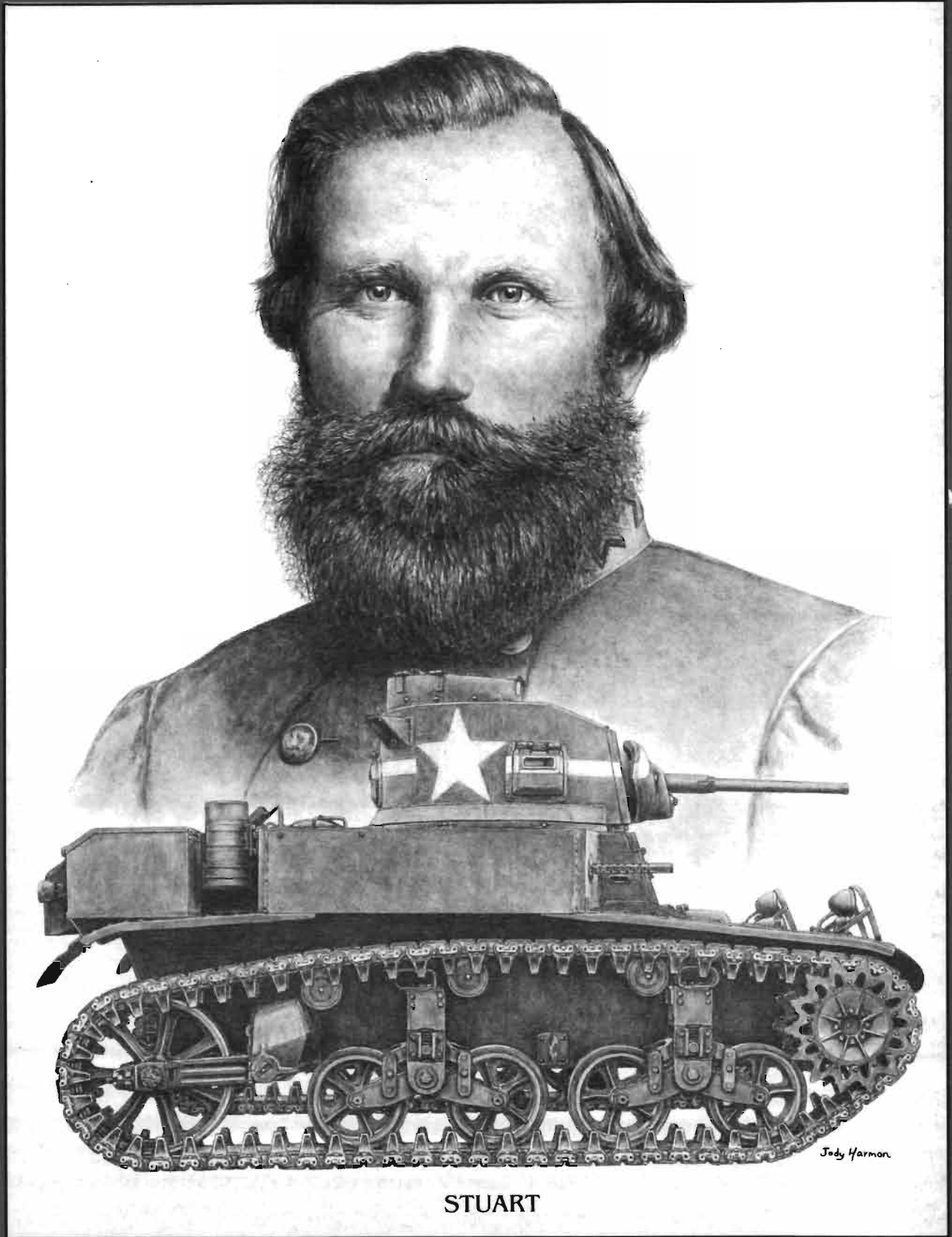

STUART

***"The Namesake Series"***

This portrait of General J.E.B. Stuart and the M3 light tank that later bore his name is another in the new series by ARMOR Contributing Artist SPC Jody Harmon. The portraits are in color and will be available through the U.S. Armor Association.